

Installing the Z9000 System

Publication Date: October 2012



Force10

Notes, Cautions, and Warnings

 **NOTE:** A NOTE indicates important information that helps you make better use of your computer.

 **CAUTION:** A CAUTION indicates either potential damage to hardware or loss of data and tells you how to avoid the problem.

 **WARNING:** A WARNING indicates a potential for property damage, personal injury, or death.

Information in this publication is subject to change without notice.

© 2012 Dell Force10. All rights reserved.

Reproduction of these materials in any manner whatsoever without the written permission of Dell Inc. is strictly forbidden.

Trademarks used in this text: Dell^(TM), the DELL logo, Dell Boomi^(TM), Dell Precision^(TM), OptiPlex^(TM), Latitude^(TM), PowerEdge^(TM), PowerVault^(TM), PowerConnect^(TM), OpenManage^(TM), EqualLogic^(TM), Compellent^(TM), KACE^(TM), FlexAddress^(TM), Force10^(TM) and Vostro^(TM) are trademarks of Dell Inc. Intel^(R), Pentium^(R), Xeon^(R), Core^(R) and Celeron^(R) are registered trademarks of Intel Corporation in the U.S. and other countries. AMD^(R) is a registered trademark and AMD Opteron^(TM), AMD Phenom^(TM) and AMD Sempron^(TM) are trademarks of Advanced Micro Devices, Inc. Microsoft^(R), Windows^(R), Windows Server^(R), Internet Explorer^(R), MS-DOS^(R), Windows Vista^(R) and Active Directory^(R) are either trademarks or registered trademarks of Microsoft Corporation in the United States and/or other countries. Red Hat^(R) and Red Hat^(R)Enterprise Linux^(R) are registered trademarks of Red Hat, Inc. in the United States and/or other countries. Novell^(R) and SUSE^(R) are registered trademarks of Novell Inc. in the United States and other countries. Oracle^(R) is a registered trademark of Oracle Corporation and/or its affiliates. Citrix^(R), Xen^(R), XenServer^(R) and XenMotion^(R) are either registered trademarks or trademarks of Citrix Systems, Inc. in the United States and/or other countries. VMware^(R), Virtual SMP^(R), vMotion^(R), vCenter^(R) and vSphere^(R) are registered trademarks or trademarks of VMware, Inc. in the United States or other countries. IBM^(R) is a registered trademark of International Business Machines Corporation.

Other trademarks and trade names may be used in this publication to refer to either the entities claiming the marks and names or their products. Dell Inc. disclaims any proprietary interest in trademarks and trade names other than its own.

Contents

- 1 Preface
 - About this Guide 7
 - Related Publications 7

- 2 The Z9000 System
 - Introduction 9
 - Orderable Z9000 Components 10
 - Features 11
 - Ports 12
 - System Status 12
 - LED Displays 12

- 3 Site Preparations
 - Site Selection 15
 - Cabinet Placement 16
 - Rack Mounting 16
 - Grounding 16
 - Fans and Airflow 16
 - Power 16
 - Storing Components 17

- 4 Install the Z9000
 - Install the Z9000 System in a Rack or Cabinet 19
 - Attach the Mounting Brackets 19
 - Install the System into the Rack or Cabinet 20
 - Attach the Ground Cable 21
 - Install the QSFP+ Optics 22
 - Remove the QSFP+ Optics 22
 - Splitting QSFP Ports to SFP+ Ports 23
 - Important Points to Know 23
 - Install the Solid State Drive 23
 - Remove the Solid State Drive 24
 - Supply Power and Power Up the System 24
 - Power Up Sequence 25
 - AC Power 25
 - DC Power 25

- 5 Power Supplies
 - Components 27

Install a Power Supply	27
Install a New AC Power Supply	28
Install a New DC Power Supply	28
Replace a Power Supply	29
Replace an AC Power Supply	29
Replace a DC Power Supply	30
6 Fans	
Components	31
Install a Fan Module	31
Replace a Fan Module	33
7 Access Ports	
Access the RJ-45/RS-232 Console Port	35
Access the RJ-45/RS-232 Console Port with a DB-9 Adapter	36
Access the USB-B Console Port	36
Access the Solid State Drive	37
Components	38
Install an SSD	38
View Files on the SSD	38
Copy Files to and from the SSD	39
Remove Files from the SSD	39
8 Specifications	
Chassis Physical Design	41
Environmental Parameters	41
AC Power Requirements	41
DC Power Requirements	42
IEEE Standards	42
Agency Compliance	42
USA Federal Communications Commission (FCC) Statement	42
Canadian Department of Communication Statement	43
European Union EMC Directive Conformance Statement	43
Japan: VCCI Compliance for Class A Equipment	43
Korean Certification of Compliance	44
Safety Standards and Compliance Agency Certifications	44
Electromagnetic Compatibility (EMC)	45
Product Recycling and Disposal	45
Battery Replacement	47
For California:	49

9	Technical Support	
	The iSupport Website	51
	Accessing iSupport Services	51
	Contacting the Technical Assistance Center	52
	Requesting a Hardware Replacement	53

Preface

About this Guide

This guide provides Z9000 site preparation recommendations, step-by-step procedures for rack mounting and desk mounting, inserting optional modules, and connecting to a power source.

After you have completed the hardware installation and power-up of the Z9000 system, for software configuration information, refer to the *FTOS Configuration Guide for the Z9000 System* and for Command Line Interface (CLI) information, refer to the *FTOS Command Line Reference Guide for the Z9000 System*.

 **NOTE:** The Z9000 system requires, at a minimum, Dell Force10 Operating System (FTOS) version 8.3.11.0.

 **CAUTION:** Wear grounding wrist straps when handling this equipment to avoid Electrostatic Discharge (ESD) damage.

 **WARNING:** Only trained and qualified personnel can perform the installation of this equipment. Read this guide before you install and power up the Z9000 system. This equipment contains two power cords. Disconnect both power cords before servicing.

 **WARNING:** This equipment contains optical transceivers, which comply with the limits of Class 1 laser radiation.



 **WARNING:** When no cable is connected, visible and invisible laser radiation may be emitted from the aperture of the optical transceiver ports. Avoid exposure to laser radiation and do not stare into the open apertures.

Related Publications

For more information about the Z9000 system, refer to the following documents:

- *FTOS Configuration Guide for the Z9000 System*
- *FTOS Command Line Reference Guide for the Z9000 System*
- *FTOS Release Notes for the Z9000 System*

 **NOTE:** For the most recent documentation and software, visit iSupport (registration for access to some sections is required): <https://www.force10networks.com/CSPortal20/Main/SupportMain.aspx>.

The Z9000 System

Introduction

The Dell Force10 Z9000 platform is a next-generation switch/router product designed to meet the requirements for distributed data center cores. It is a two-rack unit (RU) chassis that supports 32 ports of 40GE QSFP+ or 128 ports of 10GE SFP+ (with breakout cables). The Z9000 includes an RS-232 console port and a management port for system access.

As shown in the following figure, the Z9000's Input/Output (I/O) side contains the 32 40G QSFP+ auto-sensing ports and management ports.

Figure 2-1. The Z9000 System I/O-Side View

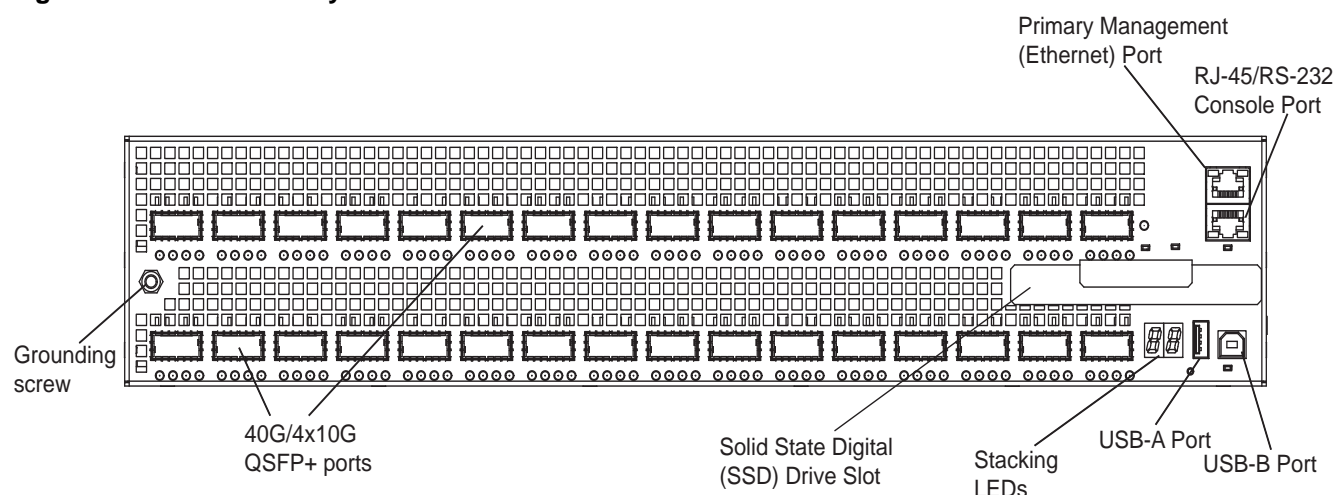

As shown in the following figure, the Z9000's Power Supply Unit (PSU) side contains the power supply units and fan modules.

Figure 2-2. The Z9000 System PSU-Side View

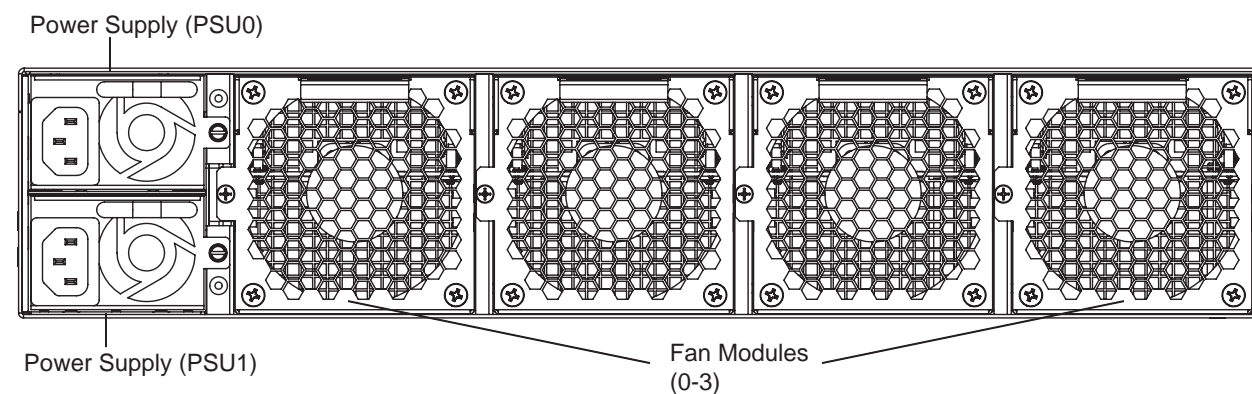

Orderable Z9000 Components

You can order the Z9000 in several different configurations. You can also order optional modules and optics separately.

Table 2-1. Supported Hardware Components

Hardware	Force10 Catalog Number	Dell Part Number
32-port 40G QSFP+ ports, 1 AC power supply, 1 fan subsystem (airflow from the I/O side to the power supply side)	Z9000-AC	K9N70
32-port 40G QSFP+ ports, 1 AC power supply, 1 fan subsystem (airflow from the power supply side to the I/O side)	Z9000-AC-R	GJKPG
32-port 40G QSFP+ ports, 1 DC power supply, 1 fan subsystem (airflow from the I/O side to the power supply side)	Z9000-DC	G9TXN
32-port 40G QSFP+ ports, 1 DC power supply, 1 fan subsystem (airflow from the power supply side to the I/O side)	Z9000-DC-R	HRXFM
Z9000 Series – Fan with airflow from the I/O side to the PSU side	Z9000-FAN	WWJVT
Z9000 Series – Fan with airflow from the PSU side to the I/O side	Z9000-FAN-R	FRD2C
Z9000 Series – AC Power supply with airflow from the I/O side to the PSU side	Z9000-PWR-AC	NY1X9
Z9000 Series – AC Power supply with airflow from the PSU side to the I/O side	Z9000-PWR-AC-R	0XRVV
Z9000 Series – DC Power supply with airflow from the I/O side to the PSU side	Z9000-PWR-DC	4JPXV
Z9000 Series – DC Power supply with airflow from the PSU side to the I/O side	Z9000-PWR-DC-R	F3WK0
Z9000 Series – Solid State Drive (SSD)	Z9000-SSD	2HYHT

Table 2-2. Supported Optics and Cables

Optic Size	Optic Type	Reach (Meters)	Force10 Catalog Number	Dell Part Number
40Gig	40G QSFP+ ESR Optics module	300 M (OM3 fiber) 400 M (OM4 fiber)	N/A	0MV31
	QSFP+ short reach optics	100 M (OM3 fiber) 150 M (OM4 fiber)	GP-QSFP-40GE-1SR	RF2MY
	Active Fiber Direct attach cable	10 M 50 M	CBL-QSFP-40GE-10M CBL-QSFP-40GE-50M	0C2YV 9JT65
	Passive Copper Direct attach cable	1 M 5M	CBL-QSFP-40GE-PASS-1M CBL-QSFP-40GE-PASS-5M	NWGTV V492M
QSFP+ Breakout Cable	40GE QSFP+ to 4 SFP+ passive breakout cable (optics not included)	5 M	CBL-QSFP-4x10GSFP-PASS-5M	HVVVF
	40GE QSFP+ to 4 SFP+ optical cable (optics not included)	5 M	CBL-QSFP-4x10GSFP-5M	1X3JJ

To successfully install the Z9000, ensure that you have the following:

- Z9000 chassis
- Optics (Optics must be ordered separately, they do NOT come with the base system.)
- At least one grounded power source per chassis
- Cable to connect the power source to the chassis (included)
- Mounting brackets for rack installation (included)
- Screws for rack installation (included)
- #1 and #2 Phillips screwdrivers (not supplied)
- Ground cable (not supplied)
- Ground cable screws (not included)
- Universal Serial Bus (USB) cable (included)
- Copper/fiber cables

Other optional components are:

- Solid State Drive (SSD) (included)
- Spare power supply unit
- Spare fan module
- Spare optics
- Breakout cable

Features

The Z9000 offers the following:

- Z9000 CPU and switch processor
- Hot-swappable redundant power supplies
- 19-inch rack-mountable
- Standard 2U chassis height
- Up to 128K MAC address entries supported with hardware assisted aging
- 12K jumbo frames support

Ports

- External serial RS-232 port (RJ45 type)
- Remote management port
- 32-port 40G QSFP+ ports
- USB-A port
- USB-B port
- SSD drive

System Status

You can view the Z9000 status information in several ways, including Light Emitting Diodes (LEDs) and boot menu options. You can also view status information through the Command Line Interface (CLI) show commands and with Simple Network Management Protocol (SNMP) traps. For more information about these options, refer to the *FTOS Command Line Reference Guide for the Z9000 System* and the *FTOS Configuration Guide for the Z9000 System*.

LED Displays

As shown in the following figure, the Z9000 includes LED displays on the I/O side of the chassis. When the Z9000 powers up or reloads, the PSU LED is solid yellow.

Figure 2-3. System LEDs

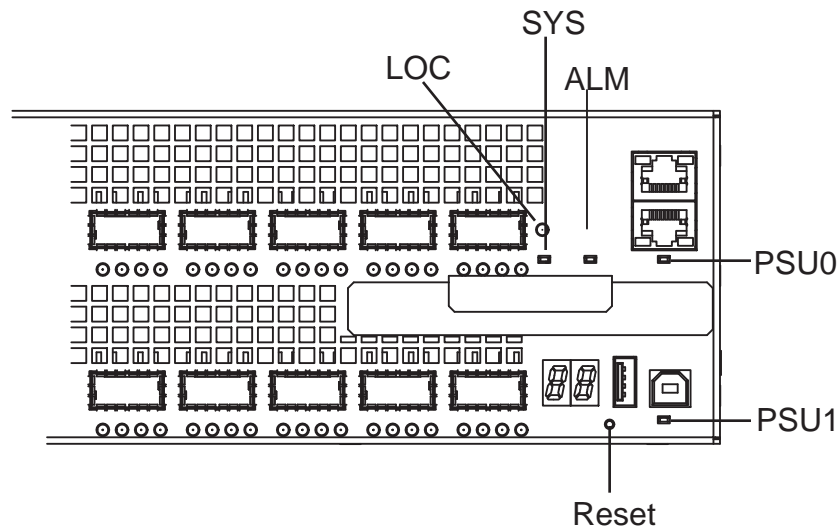

The Z9000 system LEDs are:

- System status (SYS)
- Power status (PSU)
- Alarm status (ALM)
- System locator beacon (LOC)
- System reset (Reset)

Table 2-3. System LED Displays

Label	LED Color/Display	Description
System status (SYS)	Off	No power
Located on I/O panel	Green solid	Normal operation
	Amber solid	Error during boot-up
Power status (PSU0, PSU1)	Green solid	Normal operation
Located on I/O panel	Amber solid	Power supply missing or failed
Alarm status (ALM)	Off	No alarm
Located on I/O panel	Amber solid	Minor alarm
	Red solid	Critical alarm
System locator (LOC)	Off	No activity
Located on I/O panel	Blue solid	System beacon/locator

As shown in the following figure, the Z9000 includes status indicator LEDs for each port. These ports are described in [Table 2-4](#). When the QSFP+ ports are operating in 40G mode, the left-most LED for the port is lit. When the ports are operating in 4x10G mode, only the LEDs associated with an active port are lit.

Figure 2-4. Port LEDs

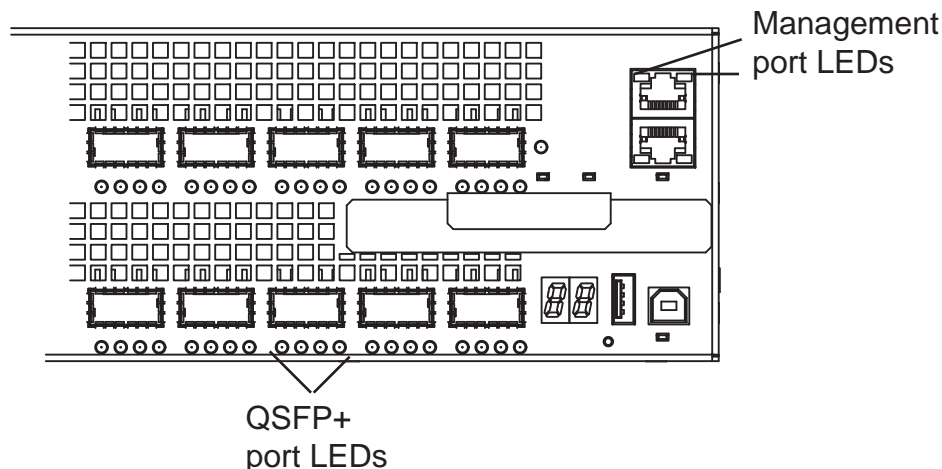

Table 2-4. Port LED Displays

Feature	Description
QSFP+ Port LED	<p>Link LED:</p> <ul style="list-style-type: none"> • Green—Link up on this port When the QSFP+ ports are operating in 40G mode, the left-most LED is lit. When the ports are operating in 4x10G mode, only the LEDs associated with an active port are lit. • Blinking Green—Activity, transmitting, or receiving packet at this port • Off—No link
Management (Ethernet) Port LEDs	<p>Link LED (right side of the port):</p> <ul style="list-style-type: none"> • Green—Link up at 1G speed • Amber—Link up at 100M or 10M speed • Off—No link <p>Activity LED (left side of the port):</p> <ul style="list-style-type: none"> • Blinking Green—Activity, transmitting, or receiving packet at this port • Off—No traffic

Site Preparations

The Z9000 is suitable for installation as part of a Common Bond Network (CBN). It can be installed in:

- network telecommunication facilities
- data centers
- other locations where the National Electric Code (NEC) applies

This chapter contains the following sections:

- [Site Selection](#)
- [Cabinet Placement](#)
- [Rack Mounting](#)
- [Grounding](#)
- [Fans and Airflow](#)
- [Power](#)
- [Storing Components](#)

For more information about Z9000 specifications, refer to [Specifications](#).

 **NOTE:** Install the Z9000 chassis into a rack or cabinet before installing any optional components.

Site Selection

Dell Force10 equipment is intended for installation in restricted access areas. A restricted access area is one in which access can only be gained by service personnel through the use of a special tool, lock, key, or other means of security and access is controlled by the authority responsible for the location.

Ensure that the area where you install your Z9000 meets the following safety requirements:

- Near an adequate power source. Connect the system to the appropriate branch circuit protection as defined by your local electrical codes.
- Environmental temperature between 32° to 104°F (0° to 40°C).
- Relative humidity that does not exceed 85% non-condensing.
- In a dry, clean, well-ventilated and temperature-controlled room, away from heat sources such as hot air vents or direct sunlight.
- Away from sources of severe electromagnetic noise.
- Positioned in a rack or cabinet, or on a desktop with adequate space in the front, rear, and sides of the Z9000 for proper ventilation and access.

Cabinet Placement

Only install the Z9000 in an indoor cabinet designed for use in a controlled environment (as described in Site Selection). Do not install the Z9000 in an outside plant cabinet.

The cabinet must meet the following criteria:

- Minimum cabinet size and airflow according to the Electronic Industries Alliance (EIA) standard.
- Minimum of five inches (12.7 cm) between the intake and exhaust vents and the cabinet wall.

Rack Mounting

When you prepare your equipment rack, ensure that the rack is earth ground. The equipment rack must be grounded to the same ground point used by the power service in your area. The ground path must be permanent.

Grounding

Use the Z9000 in a Common Bond Network (CBN). You must connect the grounding cables as described in [Install the Z9000](#).

Fans and Airflow

The Z9000 system fans support two air flow options. Be sure to order the fans suitable to support your site's ventilation. Use a single type of fan in your system. Do not mix reverse and normal fans in a single Z9000 system.

- Normal—airflow is from the I/O panel to the power supply. The grab-handle is labeled Exhaust.
- Reverse—airflow is from the power supply to the I/O panel. The grab-handle is labeled Intake.

For proper ventilation, position the Z9000 in an equipment rack (or cabinet) with a minimum of five inches (12.7 cm) of clearance around exhaust vents. When two Z9000 systems are installed near each other, position the two chassis at least five inches (12.7 cm) apart to permit proper airflow. The acceptable ambient temperature ranges are listed in [Environmental Parameters](#).

The fan speed increases and decreases automatically based on the system's state and temperature. The switch never intentionally turns off the fans.

Use the **show logging** command to see the log messages. For more information, refer to the System Logs chapters of the *FTOS Command Line Reference Guide for the Z9000 System* and the *FTOS Configuration Guide for the Z9000 System*.

Power

Use the appropriate power cord with the Z9000 system to connect the system to the applicable power source. An AC power cord is included with the system.

When installing an AC system, follow the requirements of the National Electrical Code, ANSI/NFPA 70 where applicable.

The system is powered-up as soon as the power cord is connected between the system and the power source.

 **CAUTION:** Always disconnect the power cable before the power supply slots are serviced.

 **CAUTION:** The power supply cord is used as the main disconnect device. Ensure that the socket-outlet is located/installed near the equipment and is easily accessible.

Storing Components

If you do not install your system and components immediately, Dell Force10 recommends properly storing the Z9000 and all optional components until you are ready to install them.

 **WARNING:** Electrostatic discharge (ESD) damage can occur when components are mishandled. Always wear an ESD-preventive wrist or heel ground strap when handling the Z9000 and its accessories. After you remove the original packaging, place the Z9000 and its components on an antistatic surface.

Follow these storage guidelines:

- Storage temperature must remain constant ranging from -4° to 158° F (-20°C to 70° C).
- Store on a dry surface or floor, away from direct sunlight, heat, and air conditioning ducts.
- Store in a dust-free environment.

Install the Z9000

To install the Z9000 system, Dell Force10 recommends completing the installation procedures in the order presented below.

Always handle the system and its components with care. Avoid dropping the Z9000 or its Field Replaceable Units (FRUs).

This chapter describes the installation procedures as follows:

- 1 [Install the Z9000 System in a Rack or Cabinet](#)
 - a [Attach the Mounting Brackets](#)
 - b [Install the System into the Rack or Cabinet](#)
- 2 [Attach the Ground Cable](#)
- 3 [Install the QSFP+ Optics](#)
 - a [Splitting QSFP Ports to SFP+ Ports](#)
- 4 [Install the Solid State Drive](#)
- 5 [Supply Power and Power Up the System](#)

 **WARNING:** Electrostatic discharge (ESD) damage can occur if components are mishandled. Always wear an ESD-preventive wrist or heel ground strap when handling the Z9000 and its components. As with all electrical devices of this type, take all the necessary safety precautions to prevent injury when installing this system.

Install the Z9000 System in a Rack or Cabinet

Attach the Mounting Brackets

The Z9000 is shipped with mounting brackets (rack ears) and the required screws for rack or cabinet installation. The brackets are enclosed in a package with the system.

To attach the brackets to the system, follow these steps:

Step	Task
1	Take the brackets and screws out of their packaging.
2	Attach the brackets to both sides of the system using four screws for each bracket. Attach the bracket so that the “ear” faces to the outside of the system.

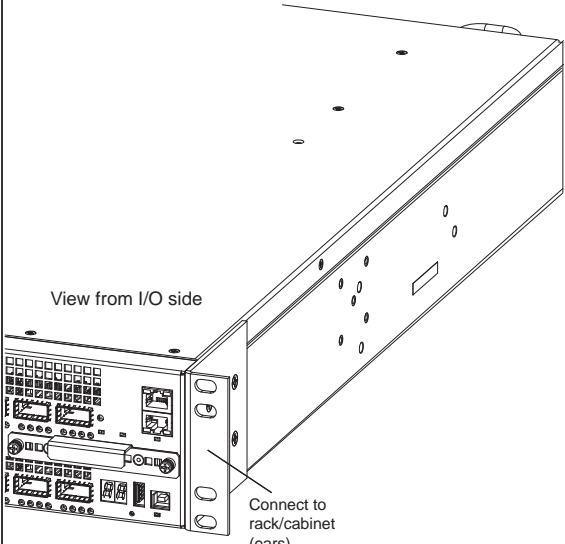

View from I/O side

Connect to rack/cabinet (ears)

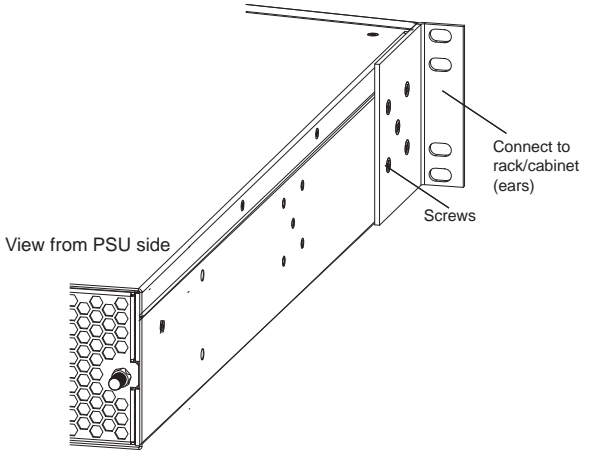

View from PSU side

Connect to rack/cabinet (ears)

Screws

Install the System into the Rack or Cabinet

Ensure that there is adequate clearance surrounding the rack or within the cabinet to permit access and airflow.

To install the system into a two-post 19-inch equipment rack using the already attached mounting brackets, follow these steps:

Step	Task
	<p>NOTE: Dell Force10 recommends using one person to hold the Z9000 in place while another person attaches the brackets to the posts.</p>

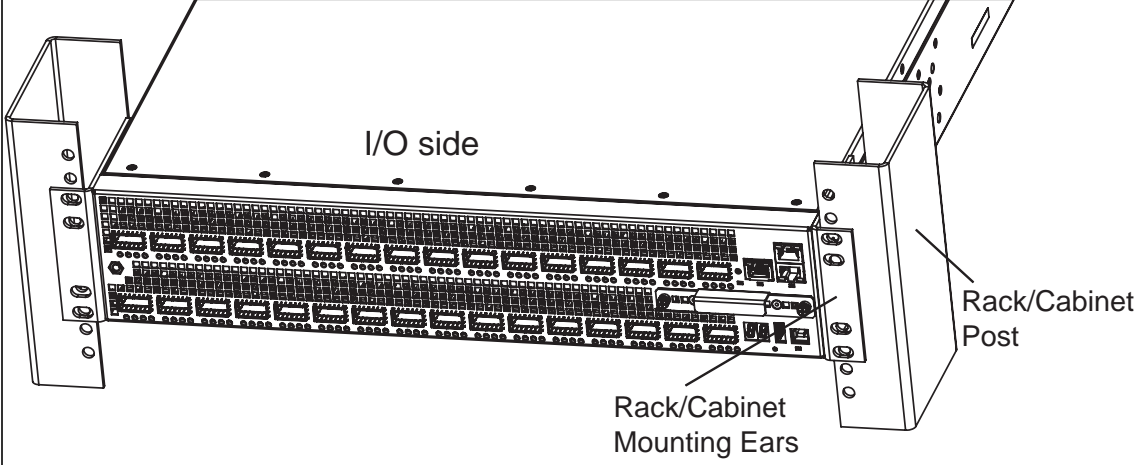
Step	Task (<i>continued</i>)
1	<p>Attach the bracket “ears” to the rack or cabinet posts using two screws for each bracket. Ensure the screws are tightened firmly. The example shows the mounting on the I/O side, but you can use either side.</p> 

Attach the Ground Cable

Use a single M4x0.7 screw to attach the ground cable to the system. The cable itself is not included with the Z9000. To properly ground the system, Dell Force10 recommends using a 6AWG one-hole lug, #10 hole size, 63" spacing (not included in shipping). The one-hole lug must be a UL recognized, crimp-type lug.

NOTE: The rack installation “ears” are not suitable for grounding.

CAUTION: Grounding conductors *must* be made of copper. Do not use aluminum conductors.

To connect the ground cable to the system, follow these steps:

NOTE: Coat the one-hole lug with an anti-oxident compound prior to crimping. Also, bring any un-plated mating surfaces to a shiny finish and coat it with an anti-oxidant prior to mating. Plated mating surfaces must be clean and free from contamination.

Step	Task
1	Take the one M4x0.7 screw from the package.
2	Cut the cable to the desired length. The cable length must facilitate the proper operation of the fault interrupt circuits. Dell Force10 recommends using the shortest cable route allowable.

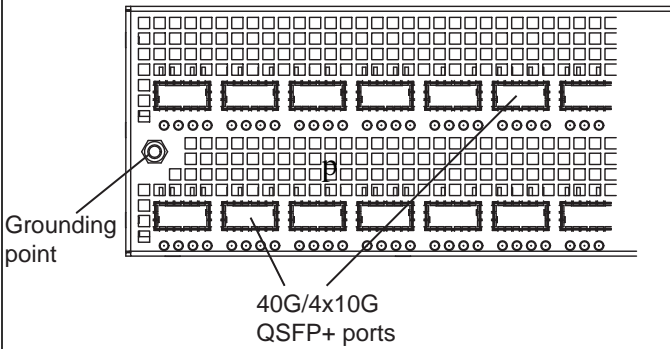
Step	Task (<i>continued</i>)
3	<p>As shown, attach the one-hole lug to the system using the supplied screw with the captive internal tooth lock washer. Torque the screw to 20 in-lbs.</p> 
4	<p>Attach the other end of the ground cable to a suitable ground point. The rack installation “ears” are not a suitable grounding point.</p>

Install the QSFP+ Optics

The Z9000 has 32 QSFP+ optical ports. For supported optics, refer to <http://www.force10networks.com/products/specifications.asp>.

⚠ WARNING: ESD damage can occur if components are mishandled. Always wear an ESD-preventive wrist or heel ground strap when handling the Z9000 system and its components.

⚠ WARNING: When working with optical fibers, follow all warning labels and always wear eye protection. Never look directly into the end of a terminated or unterminated fiber or connector as it may cause eye damage.

To install QSFP+ optics into an open port, follow these steps:

Step	Task
1	Position the optic so it is in the correct position. The optic has a key that prevents it from being inserted incorrectly.
2	<p>Insert the optic into the port until it gently snaps into place.</p> <p>🔍 NOTE: Both rows of QSFP+ ports require that the 40G optics be inserted with the tabs facing up.</p>

Remove the QSFP+ Optics

Remove an optic by pushing the tab on the optic and sliding the optic from the port.

When removing an optic with Direct Attach Cables (DACs) from the port, pull the release tab firmly and steadily. Prior to pulling the release tab, you may need to gently push the optic into the port to ensure it is seated properly. Do not jerk or tug repeatedly on the release tab.

Splitting QSFP Ports to SFP+ Ports

The Z9000 supports splitting a single 40G QSFP port into four 10G SFP+ ports using one of the supported breakout cables.

For the system to recognize the port type change, you must enter the **stack-unit portmode** command. For example:

```
stack-unit stack-unit port number portmode quad
```

- *stack-unit*: Enter the stack member unit identifier of the stack member to reset. Range: 0 to 7.
- *number*: Enter the port number of the 40G port to be split. Range: 0 to 124 in increments of 4.

Important Points to Know

- The unit number with the split ports must be the default (stack-unit 0). You can verify the unit number using the **show system brief** command. If the unit ID is different than 0, it must be renumbered to 0 before the ports are split. Renumber the unit ID by using the **stack-unit id renumber 0** command in EXEC mode.
- The quad port must be in a default configuration before you can split it into four 10G SFP+ ports. The 40G port is lost in the configuration when you split the port, so be sure the port is also removed from other L2/L3 feature configurations.
- For the split-port change to take effect, you must reload the system after issuing the change command. Be sure to save your configuration.

Install the Solid State Drive

The Z9000 includes a Solid State Drive (SSD) that acts as another storage device. The SSD is shipped installed in the Z9000 system and is located in a slot on the lower-right area on the I/O side as shown in the following figure.

The SSD is field replaceable but not hot-swappable and supports drives that use 12 Volts and/or 5.0 Volts. Be sure to use only drives supported by Dell Force10.

Figure 4-1. The SSD

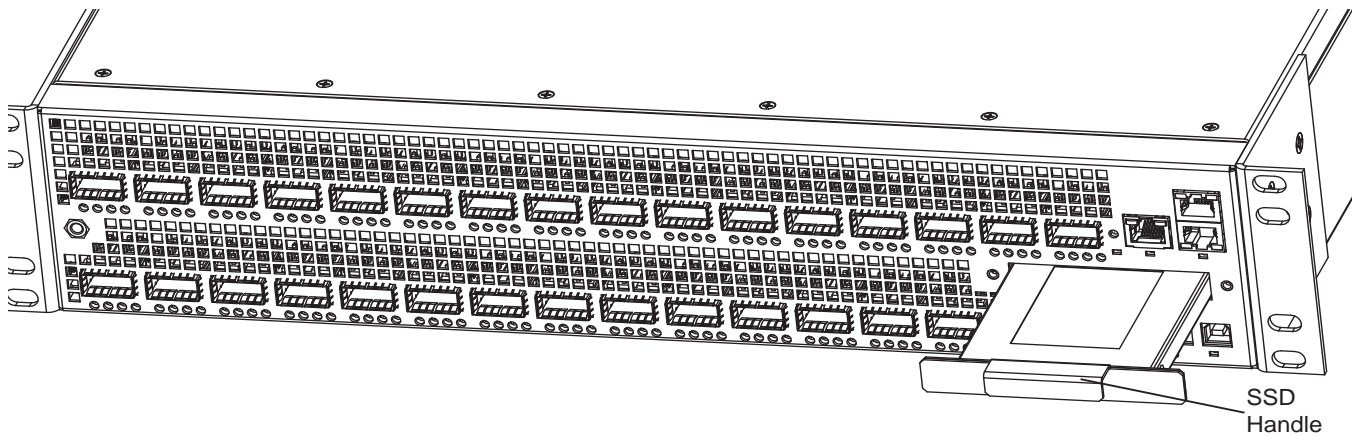

Remove the Solid State Drive

To remove and replace a SSD, follow these steps:

Step	Task
1	Shut down the system.
1	Loosen the retaining screws on the SSD.
2	Use the handle to pull the SSD out of the slot.
3	Remove the SSD and set it aside.
4	Use the SSD handle to slide the replacement SSD into the slot and firmly press it in place.
5	Finger tighten the retaining screws.
6	Restart the system.

Supply Power and Power Up the System

Supply power to the Z9000 after the system is mounted in a rack or cabinet.

Dell Force10 recommends re-inspecting your system prior to powering up. Verify that:

- the equipment is properly secured to the rack and properly grounded.
- the equipment rack is properly mounted and grounded.
- the ambient temperature around the system (which may be higher than the room temperature) is within the limits specified for the Z9000 system.
- there is sufficient airflow around the system.
- the input circuits are correctly sized for the loads and that you use sufficient over-current protection devices.
- all protective covers are in place.

NOTE: A US AC power cable is included in the shipping container for powering up an AC power supply. You must order all other power cables separately.

⚠ WARNING: ESD damage can occur if components are mishandled. Always wear an ESD-preventive wrist or heel ground strap when handling the Z9000 system and its components.

Power Up Sequence

When the system powers up, the fans come on at high speed. The fan speed slows as the system boots up. The SYS Light Emitting Diode (LED) does not light up until the boot-up sequence is complete. When the boot-up is complete, the SYS LED is steadily lit green.

AC Power

To add AC power, connect the plug to each AC power connector. Make sure the power cord is secure.

As soon as the cable is connected between the Z9000 system and the power source, the system is powered-up; there is no on/off switch.

DC Power

To add DC power, follow these steps:

Step	Task
1	Remove the small plastic cover from the DC connectors.
2	Ensure that the power source is turned off. Do not attach the DC cable to the DC connectors while the power source is on.
3	Attach the connectors to the Power Supply Units (PSUs). Make sure the connections are secure.
4	Replace the plastic cover over the DC connectors.

As soon as the cable is connected between the Z9000 system and the power source, the system is powered-up; there is no on/off switch.

Power Supplies

The Z9000 is designed to support two hot-swappable power supply units (PSUs). The Z9000 supports AC and DC power supplies with two air-flow directions (normal and reversed). Two PSUs are required for full redundancy, but the system will operate with a single PSU.

 **NOTE:** If you use a single PSU, you must install a blank plate in the other PSU slot. Dell Force10 recommends using power supply 1 (PSU1) as the blank plate slot.

The PSUs are field replaceable. When operating with full redundancy (two power supplies installed and running), you can remove and replace one PSU while the other PSU is running without interrupting traffic.

WARNING:

 **WARNING:** Electrostatic discharge (ESD) damage can occur if components are mishandled. Always wear an ESD-preventive wrist or heel ground strap when handling the Z9000 and its components.

 **WARNING:** To prevent electrical shock, ensure the Z9000 is grounded properly. If you do not ground your equipment correctly, excessive emissions may result. Use a qualified electrician to ensure that the power cables meet your local electrical requirements.

Components

The following power supply options are available for the Z9000:

- AC power supply with integrated fan (Force10 Catalog# **Z9000-PWR-AC** | Dell Part # **NY1X9**)
- AC power supply with integrated reverse flow fan (Force10 Catalog# **Z9000-PWR-AC-R** | Dell Part # **0XRVV**)
- DC power supply with integrated fan (Force10 Catalog# **Z9000-PWR-DC** | Dell Part # **4JPXV**)
- DC power supply with integrated reverse flow fan (Force10 Catalog# **Z9000-PWR-DC-R** | Dell Part # **F3WK0**)

Install a Power Supply

The PSUs in the Z9000 are field replaceable. When both power supplies are installed and running, you can remove one power supply without interrupting traffic. To install a new PSU or to replace a PSU, use the following procedures.

 **WARNING:** Prevent exposure and contact with hazardous voltages. Do not attempt to operate this system with the safety cover removed.

 **CAUTION:** Remove the power cable from the PSU prior to removing the PSU. Also, do not connect the power cable before you insert the PSU in the system.

CAUTION: Be sure that the DC power source is turned off before attaching the cables to the DC connectors on the Z9000.

Power Supply 0 (PSU0) is on the top of the Z9000; power supply 1 (PSU1) is on the bottom of the Z9000 system.

Install a New AC Power Supply

Figure 5-1. AC Power Supply

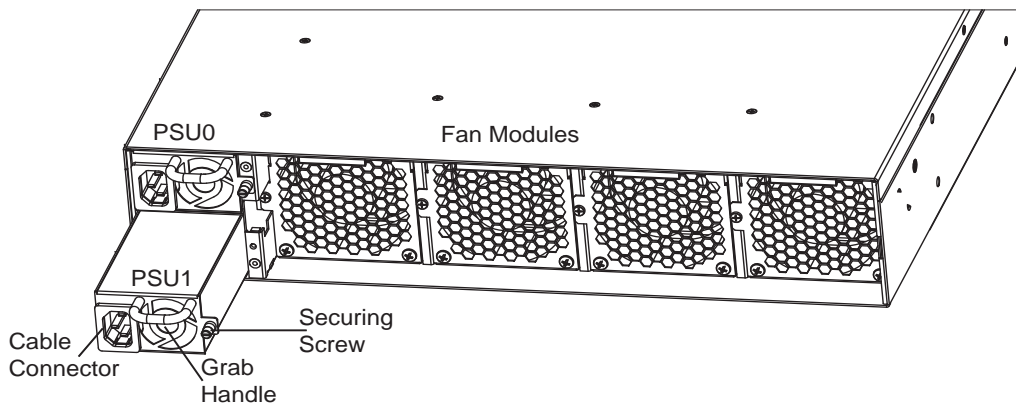

To install a new AC power supply, follow these steps:

NOTE: The PSU slides into the slots smoothly. Do not force the PSU into a slot as this may damage the PSU or the chassis.

Step	Task
1	Take the PSU out of the shipping box.
2	Use the grab handle to slide the PSU into the power supply bay.
3	Tighten the securing screw on the side of the PSU. Ensure that the PSU is secure.
4	Attach the power cable.
NOTE: The system powers up as soon as the cables are connected between the power supply and the power source.	

Install a New DC Power Supply

Figure 5-2. DC Power Supply

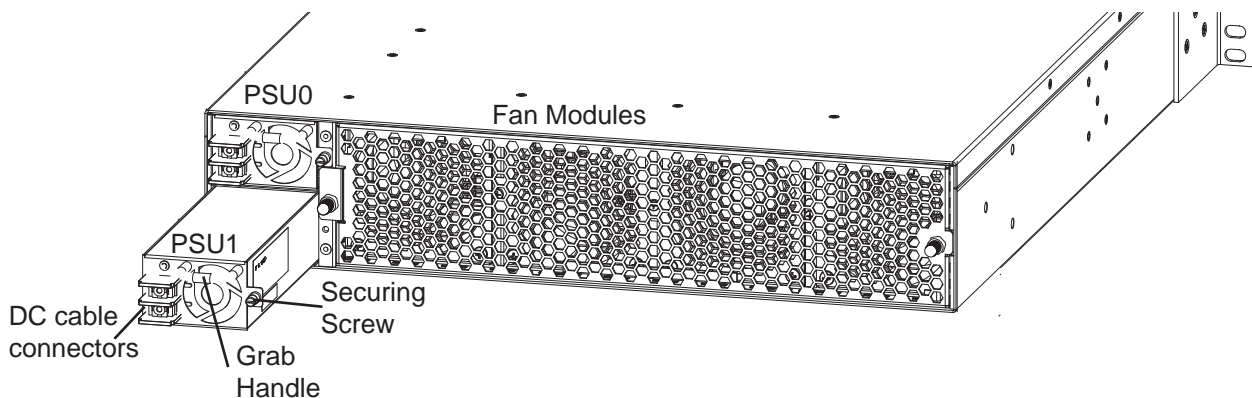



To install a new DC power supply, follow these steps:

 **NOTE:** The PSU slides into the slot smoothly. Do not force the PSU into a slot as this may damage the PSU or the chassis

Step	Task
1	Take the PSU out of the shipping box.
2	Remove the small plastic cover over the DC cable connectors. Do not throw the cover away as you will replace it when you complete the installation.
3	Ensure that the DC power source is turned OFF.
4	Use the grab handle to slide the PSU into the power supply bay.
5	Tighten the securing screw on the side of the PSU. Ensure that the PSU is secure.
6	Attach the power cables.
7	Replace the small plastic cover over the DC cable connectors.
8	Turn the DC power source ON.

Replace a Power Supply

 **NOTE:** If a PSU fails, it must be completely replaced. There are no field servicable components in the PSU. For help replacing a PSU, refer to [Requesting a Hardware Replacement](#).

 **NOTE:** If you use a single PSU, you must install a blank plate in the other PSU slot. Dell Force10 recommends using power supply 1 (PSU1) as the blank plate slot.

Replace an AC Power Supply

To replace an AC PSU, follow these steps:

 **NOTE:** The PSU slides into the slot smoothly. Do not force the PSU into a slot as this may damage the PSU or the chassis.

Step	Task
1	Disconnect the power cable from the PSU.
2	Use the grab handle to slide the PSU out of the power supply bay.
3	Use the grab handle on the replacement unit to slide it into the power supply bay.
4	Tighten the securing screw on the side of the PSU. Ensure that the PSU is secure.
5	Attach power cable.
	NOTE: The system powers up as soon as the cables are connected between the power supply and the power source.

Replace a DC Power Supply

To replace a DC power supply, follow these steps:

 **NOTE:** The PSU slides into the slot smoothly. Do not force the PSU into a slot as this may damage the PSU or the chassis.

Step	Task
1	Turn the DC power source OFF.
2	Remove the small plastic cover over the DC cable connectors. Do not throw the cover away as you will replace it when you complete the installation.
3	Disconnect the power cable from the PSU.
4	Use the grab handle to slide the PSU out of the power supply bay.
5	Use the grab handle on the replacement unit to slide it into the power supply bay.
6	Replace the small plastic cover over the DC cable connectors.
7	Tighten the securing screw on the side of the PSU. Ensure that the PSU is secure.
8	Attach the power cables.
9	Turn the DC power source ON.

Fans

The Z9000 comes from the factory with one power supply and four fan modules installed in the system. If two or more fans are installed and running, the fan modules are hot-swappable.

The Z9000 supports two airflow direction options. Do not mix airflow directions; only a single airflow direction can be used in a system. If the airflow directions are mismatched, the system powers down in one minute.

- Normal—airflow is from the I/O panel to the power supply. The grab-handle is labeled Exhaust.
- Reverse—airflow is from the power supply to the I/O panel. The grab-handle is labeled Intake.

Environmental factors can decrease the amount of time required between fan replacements. Check the environmental factors regularly. An increase in temperature and/or particulate matter in the air might affect performance (for example, new equipment installation).

CAUTION: If the wrong fan air flow is ordered or if the wrong fans are received with your Z9000, the entire Z9000 must be replaced. Normal fans **cannot** be swapped with reverse air flow fans; the unit must be replaced.

CAUTION: Check the fans at six-month intervals and replace them as necessary. In order to accurately determine replacement intervals, regularly monitor the speeds of the cooling fans.

Components

- Z9000 Fan module (Force10 Catalog# **Z9000-FAN** | Dell Part # **WWJVT**)
- Z9000 Fan module - Reverse flow (Force10 Catalog# **Z9000-FAN-R** | Dell Part # **FRD2C**)

Install a Fan Module

The fan modules in the Z9000 are field replaceable. Module Slot 0 is on the left; Module Slot 3 is on the right.

To install a new fan module, follow these steps:

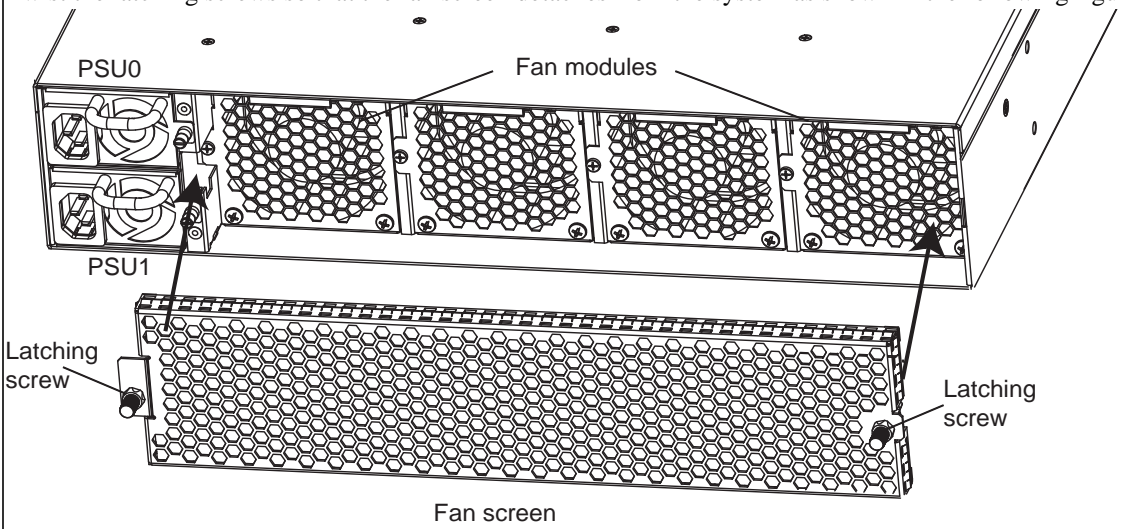
Step	Task
1	<p>Twist the latching screws so that the fan screen detaches from the system as shown in the following figure.</p>  <p>The diagram illustrates the process of detaching the fan screen. The top portion shows a server chassis with two power supply units (PSU0 and PSU1) on the left and four fan modules in the center. The bottom portion shows the fan screen being removed, with two latching screws on its sides. Arrows indicate the direction of the latching screws being twisted to detach the screen.</p>
2	Remove the screen and set it aside.
3	Take the fan module out of the shipping box.
4	Use the grab handle to slide the module into the bay.
5	Tighten the securing screw on the side of the module.
6	Replace the fan screen.
7	Twist the latching screws to the fan screen until it is securely attached to the system.

Replace a Fan Module

To replace a fan module, follow these steps:

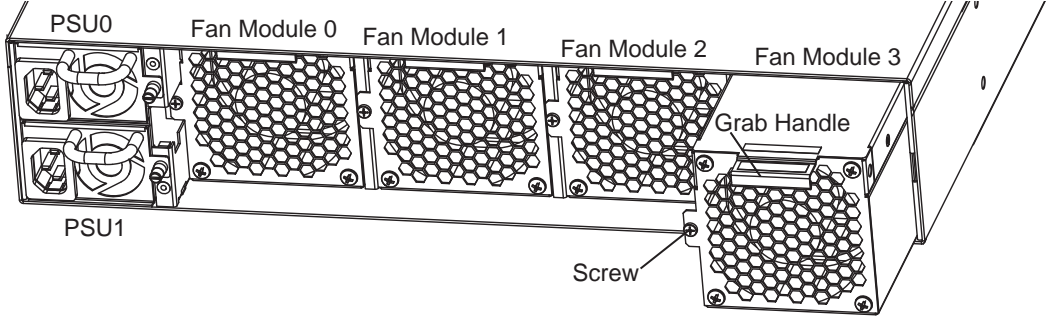
Step	Task
1	Twist the latching screws so that the fan screen detaches from the system. 
2	Remove the fan screen and set it aside.
3	Loosen the securing screw on the side of the module.
	⚠ CAUTION: You must complete steps 4 and 5 within one minute or the system will power down.
4	Use the grab handle on the module to slide it out of the bay.
5	Use the grab handle on the replacement module to slide it into the bay.
6	Tighten the captive screw on the module with a screwdriver. Ensure that the module is secure.
7	Replace the fan screen.
8	Twist the latches to the fan screen until it is securely attached to the system.

Access Ports

The Z9000 has two management ports available for system access—a console port and a Universal Serial Bus (USB)-B port. The USB-B ports act exactly the same as the console port. The terminal settings are the same for both access ports.

Access the RJ-45/RS-232 Console Port

On the I/O side of the Z9000 system, the RJ-45/RS-232 console port is labeled in the upper right-hand corner as shown in the following figure.

Figure 7-1. RJ-45/RS-232 Console Port Connector

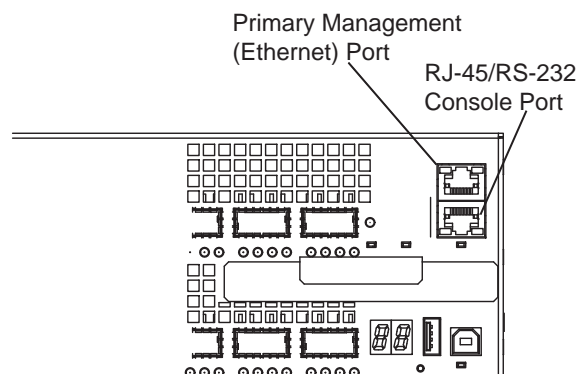

For the RJ-45/RS-232 console port pinout assignments, refer to [Table 7-1](#).

To access the RJ-45/RS-232 console port, follow these steps:

Step	Task
1	Install an RJ-45 copper cable into the console port. Use a rollover cable to connect the Z9000 console port to a terminal server.
2	Connect the other end of the cable to the Data Terminal Equipment (DTE) serial port on the PC or terminal server.
3	Keep the default terminal settings on the console as follows: <ul style="list-style-type: none"> • 9600 baud rate • No parity • 8 data bits • 1 stop bit • No flow control

Access the RJ-45/RS-232 Console Port with a DB-9 Adapter

You can connect to the console using an RJ-45 to DB-9 adapter along with the RJ-45 rollover cable if the DTE has a DB-9 interface. [Table 7-1](#) lists the pin assignments.

Table 7-1. Pin Assignments Between the Console and a DTE Terminal Server

Console Port	RJ-45 to RJ-45 Rollover Cable		RJ-45 to DB-9 Adapter	Terminal Server Device
	RJ-45 pinout	RJ-45 Pinout	DB-9 Pin	Signal
RTS	1	8	8	CTS
NC	2	7	6	DSR
TxD	3	6	2	RxD
GND	4	5	5	GND
GND	5	4	5	GND
RxD	6	3	3	TxD
NC	7	2	4	DTR
CTS	8	1	7	RTS

Access the USB-B Console Port

The terminal settings are the same for the USB-B port and the console port:

- 9600 baud rate
- No parity
- 8 data bits
- 1 stop bit
- No flow control

When you connect the USB-B port, it becomes the primary connection and, when the system is connected, it sends all messages to the USB-B drive.

Figure 7-2. USB-B Console Port Connector

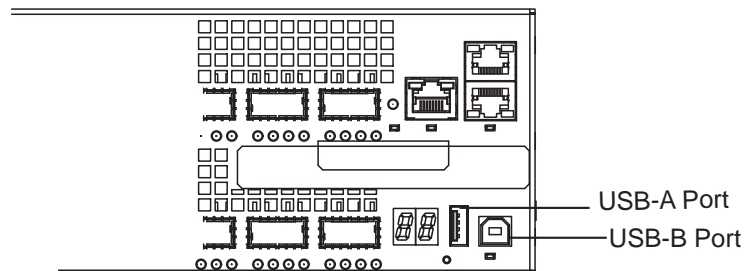

NOTE: Before starting this procedure, be sure you have a terminal emulation program already installed on your PC. You will also need the appropriate drivers for the USB device you use. For assistance, contact Dell Force10 Technical Support.

To access the USB-B console port, follow these steps:

Step	Task
1	Power on the PC (Dell Force 10 recommends using the XP operating system).
2	Connect the USB-A end of cable into an available USB port on the PC.
3	Connect the USB-B end of cable into the USB-B console port on the Z9000.
4	Power on the Z9000.
5	Install the necessary USB device drivers (you will need an internet connection). For assistance, contact Dell Force10 Technical Support.
6	Open your terminal software emulation program to access the Z9000.
7	Set the terminal connection settings. Use the settings shown here: <ul style="list-style-type: none"> • 9600 baud rate, No parity, 8 data bits, 1 stop bit, No flow control 
	The Command Line Interface (CLI) prompt appears (FTOS>_) when you are connected to the Z9000.

Access the Solid State Drive

A 32GB Solid State Drive (SSD) is shipped with the Z9000. You can also order the SSD separately. The SSD acts as an external flash and is accessed as **slot0:** on the system. You view and manage the SSD contents through the CLI, similar to the flash drives.

The SSD is field replaceable and supports drives that use 12 Volts and/or 5.0 Volts. Be sure to use only drives supported by Dell Force10.

 **NOTE:** You **cannot** hot-swap the SSD. You must reboot the Z9000 to recognize a new or reseated SSD.

Figure 7-3. SSD Drive



Components

The following SSD option is available:

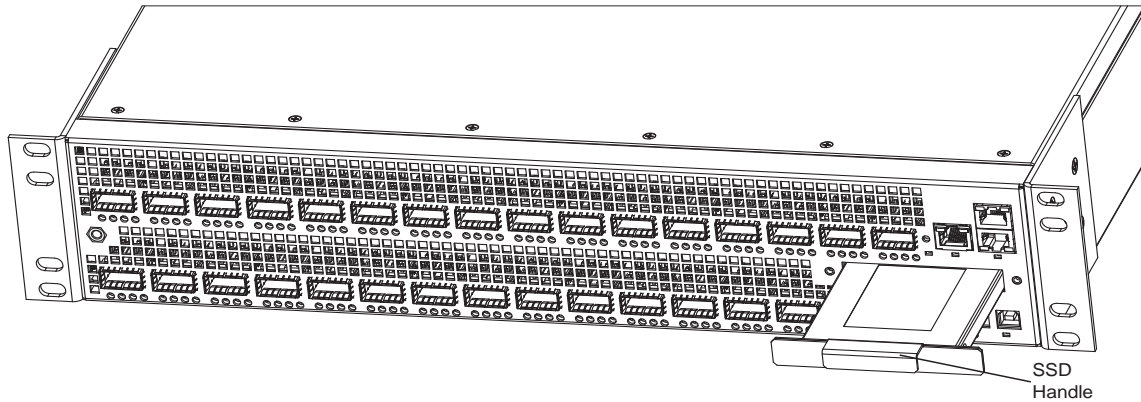
- Z9000 Solid State Drive (Force10 Catalog# **Z9000-SSD** | Dell Part Number: **2HYHT**)

Install an SSD

To install an SSD, follow these steps:

Step	Task
1	Shut down the system. You cannot hot-swap the SSD; you must reboot the system to recognize a new or reseated SSD.
1	Take the SSD out of the shipping box.
2	Use the grab handle to slide the SSD into the slot.
3	Restart the system.

Included here are some key commands supported by the SSD. For a complete description of the commands supported by the SSD, refer to the *FTOS Command Line Reference Guide for the Z9000 System*.

View Files on the SSD

To view files on the SSD, use the `dir slot0:` command. For example:

```
FTOS#dir slot0:
```

```
Directory of slot0:
```

```

 1 drw-   32768   Jan 01 1980 00:00:00  .
 2 drwx    512   Jul 23 2007 00:38:44  ..
 3 drw-   8192   Mar 30 1919 10:31:04  TRACE_LOG_DIR
 4 drw-   8192   Mar 30 1919 10:31:04  CRASH_LOG_DIR
 5 drw-   8192   Mar 30 1919 10:31:04  NVTRACE_LOG_DIR

```

```
6 drw-      8192   Mar 30 1919 10:31:04  CORE_DUMP_DIR
7 d---      8192   Mar 30 1919 10:31:04  ADMIN_DIR
```

--More--

Copy Files to and from the SSD

To copy files to or from the SSD, use the **copy** command. For example:

Copy from an FTP site to the SSD:

```
FTOS#copy ftp://myusername:mypassword@10.10.10.10//FTOS/FTOS-ZB-8.3.11.0.bin slot0:/
/
Destination file name [FTOS-ZB-8.3.11.0.bin.bin]:
!!!!!!!!!!!!!!!!!!!!!!!!!!!!!!!!!!!!!!!!!!!!!!!!!!!!!!!!!!!!!!!!!!!!!!!!!!!!
26292881 bytes successfully copied
```

Copy from the internal flash to the SSD.

```
FTOS#copy flash: slot0:boot-image
Destination file name [FTOS-ZB-8.3.11.0.bin.bin]:
!!!!!!!!!!!!!!!!!!!!!!!!!!!!!!!!!!!!!!!!!!!!!!!!!!!!!!!!!!!!!!!!!!!!!!!!!!!!
26292881 bytes successfully copied
```

Remove Files from the SSD

To remove files from the SSD, use the **delete** command. For example:

```
FTOS#delete slot0://[filepath]
```

Specifications

This chapter contains the following sections:

- Chassis Physical Design
- [Agency Compliance](#)

Chassis Physical Design

Parameter	Specifications
Height	3.48 inches (8.8 cm)
Width	17.32 inches (44.0 cm)
Depth	24.00 inches (61.00 cm)
Chassis weight	50.3 lbs (approx.) (22.8 kg)
Rack clearance required	Front: 5-inches (12.7 cm) Rear: 5-inches (12.7 cm)
Thermal dissipation	2692 BTU/h (789 W)

Environmental Parameters

Parameter	Specifications
Temperature	32° to 104°F (0° to 40°C) -40° to 158°F (-20° to 70°C)
Maximum altitude	No performance degradation to 10,000 feet (3,048 meters)
Relative humidity	10 to 85% non-condensing

AC Power Requirements

Parameter	Specifications
Nominal input voltage	100 to 240 VAC, 50/60 Hz
Maximum AC power supply input current	8.00 A @ 100/120VAC 4.00 A @ 200/240 VAC
Maximum system power input	789 W

DC Power Requirements

Parameter	Specifications
Nominal input voltage	-40 to -60 VDC
Maximum DC power supply input current	16.5 A @ -48 VDC
Maximum system power input	789 W

IEEE Standards

The Z9000 complies with the following IEEE standards:

- 802.3ae 10 Gigabit Ethernet
- 802.3ab 1000Base-T
- 802.1p L2 Prioritization
- 802.1Q VLAN Tagging, Double VLAN Tagging (Q in Q), GVRP
- 802.1s Multiple Spanning Tree Protocol
- 802.1w Rapid Spanning Tree Protocol
- 802.3ad Link Aggregation with LACP
- 802.1D Bridging, STP
- 802.3x Flow Control
- 802.1ac Frame Extension for VLAN Tagging
- 802.1x Port Based Network Access Control

Agency Compliance

The Z9000 is designed to comply with the following safety and agency requirements.

USA Federal Communications Commission (FCC) Statement

This equipment has been tested and found to comply with the limits for a Class A digital device, pursuant to Part 15 of the FCC rules. These limits are designated to provide reasonable protection against harmful interference when the equipment is operated in a commercial environment. This equipment generates, uses, and can radiate radio frequency energy. If it is not installed and used in accordance to the instructions, it may cause harmful interference to radio communications. Operation of this equipment in a residential area is likely to cause harmful interference, in which case users will be required to take whatever measures necessary to correct the interference at their own expense.

Properly shielded and grounded cables and connectors must be used in order to meet FCC emission limits. Dell Force10 is not responsible for any radio or television interference caused by using other than recommended cables and connectors or by unauthorized changes or modifications in the equipment. Unauthorized changes or modification could void the user's authority to operate the equipment.

This device complies with Part 15 of the FCC Rules. Operation is subject to the following two conditions: (1) this device may not cause harmful interference, and (2) this device must accept any interference received, including interference that may cause undesired operation.

Canadian Department of Communication Statement

Industry Canada Class A emission compliance statement

This Class A digital apparatus complies with Canadian ICES-003.

Avis de conformité à la réglementation d'Industrie Canada

Cet appareil numérique de la classe A est conforme à la norme NMB-003 du Canada.

European Union EMC Directive Conformance Statement

This product is in conformity with the protection requirements of EU Council Directive 2004/108/EC on the approximation of the laws of the Member States relating to electromagnetic compatibility. Dell Force10 can not accept responsibility for any failure to satisfy the protection requirements resulting from a non-recommended modification of this product, including the fitting of non-Dell Force10 option cards.

This product has been tested and found to comply with the limits for Class A Information Technology Equipment according to CISPR 22/European Standard EN 55022. The limits for Class A equipment were derived for commercial and industrial environments to provide reasonable protection against interference with licensed communication equipment.

⚠ WARNING: This is a Class A product. In a domestic environment, this device may cause radio interference, in which case, the user may be required to take adequate measures.

European Community Contact
Dell Force10, EMEA - Central
Dahlienweg 19
66265 Heusweiler
Germany

<http://www.force10networks.com/german/>
Tel: +49 172 6802630
Email: EMEA Central Sales

Japan: VCCI Compliance for Class A Equipment

この装置は、情報処理装置等電波障害自主規制協議会（VCCI）の基準に基づくクラスA情報技術装置です。この装置を家庭環境で使用すると電波妨害を引き起こすことがあります。この場合には使用者が適切な対策を講ずるよう要求されることがあります。

This is Class A product based on the standard of the Voluntary Control Council For Interference by Information Technology Equipment (VCCI). If this equipment is used in a domestic environment, radio disturbance may arise. When such trouble occurs, the user may be required to take corrective actions.

⚠ WARNING: Use the AC Power cords with Dell Force10 equipment only. Do not use Dell Force10 AC power cords with any unauthorized hardware.

本製品に同梱いたしております電源コードセットは、本製品専用です。本電源コードセットは、本製品以外の製品ならびに他の用途でご使用いただくことは出来ません。製品本体には同梱された電源コードセットを使用し、他製品の電源コードセットを使用しないで下さい。

Korean Certification of Compliance

A급 기기 (업무용 방송통신기자재)	이 기기는 업무용(A급) 전자파적합기기로서 판매자 또는 사용자는 이 점을 주의하시기 바라며, 가정외의 지역에서 사용하는 것을 목적으로 합니다.
------------------------	---------------------------------------------------------------------------------

Korean Package Label

	 [equipment type]
품명(Product Name)	Ethernet Switch
모델명(Model)	[model number]
신청인(Applicant)	Force10 Networks, Inc.
제조사(Manufacturer)	Delta Networks, (Dongguan) Ltd.
제조년월(Manufacturing Date)	[date]
제조국(Country of Origin)	China

Safety Standards and Compliance Agency Certifications

- CUS UL 60950-1, 2nd Edition
- CSA 60950-1-03, 2nd Edition
- EN 60950-1, 2nd Edition
- EN 60825-1, 1st Edition
- EN 60825-1 Safety of Laser Products—Part 1: Equipment Classification Requirements and User's Guide
- EN 60825-2 Safety of Laser Products—Part 2: Safety of Optical Fibre Communication Systems
- FDA Regulation 21CFR 1040.10 and 1040.11
- IEC 60950-1, 2nd Ed, including all National Deviations and Group Differences

Electromagnetic Compatibility (EMC)

Emissions

- International: CISPR 22: 2006, Class A
- Australia/New Zealand: AS/NZS CISPR 22: 2006, Class A
- Canada: ICES-003, Issue-4, Class A
- Europe: EN55022 2006 (CISPR 22: 2006), Class A
- Japan: VCCI V3/ 2007.04 Class A
- USA: FCC CFR47 Part 15, Subpart B, Class A

Immunity

- EN 300 386 v1.3.3: 2005 EMC for Network Equipment
- EN55022 2006, Class A
- EN 55024 1998 + A1: 2001 + A2: 2003
- EN 61000-3-2 Harmonic Current Emissions
- EN 61000-3-3 Voltage Fluctuations and Flicker
- EN 61000-4-2 ESD
- EN 61000-4-3 Radiated Immunity
- EN 61000-4-4 EFT
- EN 61000-4-5 Surge
- EN 61000-4-6 Low Frequency Conducted Immunity

Product Recycling and Disposal

This switch must be recycled or discarded according to applicable local and national regulations. Dell Force10 encourages owners of information technology (IT) equipment to responsibly recycle their equipment when it is no longer needed. Dell Force10 offers a variety of product return programs and services in several countries to assist equipment owners in recycling their IT products.

Waste Electrical and Electronic Equipment (WEEE) Directive for Recovery, Recycle and Reuse of IT and Telecommunications Products

Dell Force10 switches are labeled in accordance with European Directive 2002/96/EC concerning waste electrical and electronic equipment (WEEE). The Directive determines the framework for the return and recycling of used appliances as applicable throughout the European Union. This label is applied to various products to indicate that the product is not to be thrown away, but rather reclaimed upon end of life per this Directive.

The European WEEE Symbol



In accordance with the European WEEE Directive, electrical and electronic equipment (EEE) is to be collected separately and to be reused, recycled, or recovered at end of life. Users of EEE with the WEEE marking per Annex IV of the WEEE Directive, as shown above, must not dispose of end of life EEE as unsorted municipal waste, but use the collection framework available to customers for the return, recycling and recovery of WEEE. Customer participation is important to minimize any potential effects of EEE on the environment and human health due to the potential presence of hazardous substances in EEE.

Dell Force10 products, which fall within the scope of the WEEE, are labeled with the crossed-out wheelie-bin symbol, as shown above, as required by WEEE.

For information on Dell Force10 product recycling offerings, see the WEEE Recycling instructions on iSupport at: <https://www.force10networks.com/CSPortal20/Support/WEEEandRecycling.pdf>. For more information, contact the Dell Force10 Technical Assistance Center (TAC) (see [Contacting the Technical Assistance Center](#)).

SD Card Removal

To support high security environments, you can remove and re-install the SD card. Dell Force10 recommends removing the card only when necessary. In addition, the card should only be removed and replaced by authorized personnel.

CAUTION: The SD card must only be removed to support high security operations and after discussions with Dell Force10 Technical Support or your Dell Force10 representative.

To open the case and remove the SD card, follow these steps:

Step	Task
1	Remove the small phillips screws that connect the top of the SD card to the body. The screws are located on the top and the sides of the chassis.
2	Slide the top backwards until the front flange slides free of the faceplate. Lift the top off.
3	Gently push the SD card to release it from the slot.

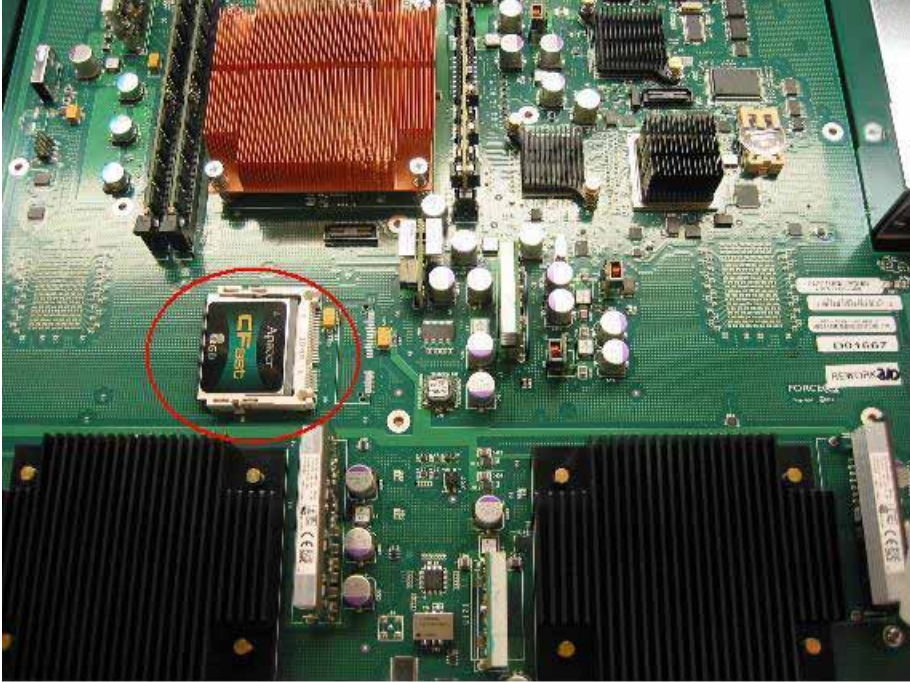
Step	Task (<i>continued</i>)
4	Remove the card. 

Battery Replacement

The lithium battery is *not field replaceable*. Only authorized personnel should remove and replace the lithium battery. If the battery requires replacement, contact Dell Force10 Technical Support.

⚠ WARNING: Electrostatic discharge (ESD) damage can occur if components are mishandled. Always wear an ESD-preventive wrist or heel ground strap when handling the Z9000 and its components. As with all electrical devices of this type, take all the necessary safety precautions to prevent injury when installing this system.

To open the case and remove the battery, follow these steps:

Step	Task
1	Remove the small phillips screws that connect the top to the body. The screws are located on the top and the sides of the chassis.
2	Slide the top backwards until its front flange slides free of the faceplate. Lift the top off.
3	Insert a small, flat screw-driver blade under the battery and in one of the slots of the plastic retainer underneath the battery.

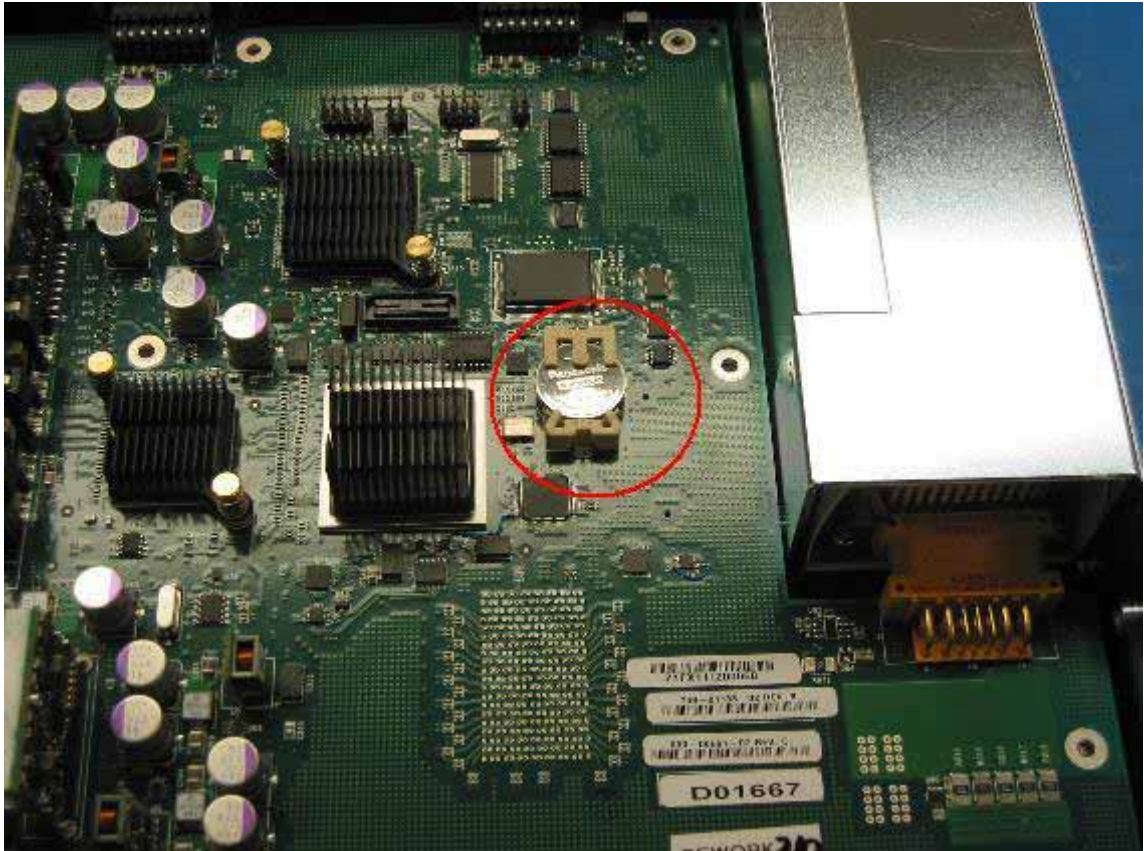
Step	Task (<i>continued</i>)
4	<p>Lever the battery up against the coin cell clip (the hold-down lead on top of the battery) far enough to provide room for the battery to be lifted above the edge of its retainer.</p> 

Batteries or packaging for batteries are labeled in accordance with European Directive 2006/66/EC concerning batteries and accumulators and waste batteries and accumulators. The Directive determines the framework for the return and recycling of used batteries and accumulators as applicable throughout the European Union. This label is applied to various batteries to indicate that the battery is not to be thrown away, but rather reclaimed upon end of life per this Directive.

In accordance with the European Directive 2006/66/EC, batteries and accumulators are labeled to indicate that they are to be collected separately and recycled at end of life. The label on the battery may also include a chemical symbol for the metal concerned in the battery (Pb for lead, Hg for mercury, and Cd for cadmium). Users of batteries and accumulators must not dispose of batteries and accumulators as unsorted municipal waste, but use the collection framework available to customers for the return, recycling, and treatment of batteries and accumulators.

Customer participation is important to minimize any potential effects of batteries and accumulators on the environment and human health due to the potential presence of hazardous substances. For proper collection and treatment, contact your local Dell Force10 representative.

Figure 8-1. The European WEEE Symbol



For California:

Perchlorate Material—Special handling may apply. For more information, refer to:
<http://www.dtsc.ca.gov/hazardouswaste/perchlorate>

The foregoing notice is provided in accordance with California Code of Regulations Title 22, Division 4.5 Chapter 33. Best Management Practices for Perchlorate Materials.

Technical Support

This chapter contains the following sections:

- [The iSupport Website](#)
- [Contacting the Technical Assistance Center](#)
- [Requesting a Hardware Replacement](#)

The iSupport Website

iSupport provides a range of documents and tools to assist you with effectively using Dell Force10 equipment and mitigating the impact of network outages. Through iSupport you can obtain technical information regarding Dell Force10 products, access to software upgrades and patches, and open and manage your Technical Assistance Center (TAC) cases. Dell Force10 iSupport provides integrated, secure access to these services.

Accessing iSupport Services

The URL for iSupport is <http://www.force10networks.com/support/>. You must have a userid and password to access iSupport services. If you do not have a userid and password, you can request these at the website.

To request a userid, password, and iSupport services, follow these steps:

Step	Task
1	On the Dell Force10 iSupport page, click the Account Request link.
2	Fill out the User Account Request form and click Send . You will receive your userid and password by E-mail.
3	To access iSupport services, click the LOGIN link and enter your userid and password.

Contacting the Technical Assistance Center

How to Contact Dell Force10 TAC	Log in to iSupport at http://www.force10networks.com/support/ and select the Service Request tab.
Information to Submit When Opening a Support Case	<ul style="list-style-type: none"> • Your name, company name, phone number, and E-mail address • Preferred method of contact • Model number • Software version number • Serial number (required) • Dell Service Tag (required) • Chassis color (required) • Symptom description • Screen shots showing the symptom, including any error messages. These can include: <ul style="list-style-type: none"> • Output from the show tech-support [non-paged] command. (This report is very long so set the storage buffer in your terminal program to high.) • Output from the show logging eventlog [unit] command, where the unit is the stack ID of the member unit that experienced the failure (This report is included as a section in the output from the show tech-support [non-paged] command.) • Console captures showing the error messages • Console captures showing the troubleshooting steps taken • Saved messages to a syslog server, if you use one
Managing Your Case	Log in to iSupport and select the Service Request tab to view all open cases and Return Materials Authorizations (RMAs).
Downloading Software Updates	Log in to iSupport and select the Software Center tab.
Technical Documentation	Log in to iSupport and select the Documents tab. You can access this page without logging in if you use the Documentation link on the iSupport page.
Contact Information	<p>E-mail: support@force10networks.com</p> <ul style="list-style-type: none"> • Web: http://www.force10networks.com/support/ • Telephone: <ul style="list-style-type: none"> • US and Canada: 866.965.5800 • International: 408.965.5800

Requesting a Hardware Replacement

To request replacement hardware, follow these steps:

Step	Task
1	Determine the part number and serial number of the component you wish to replace. <ul style="list-style-type: none">• To list the numbers for all the components installed in the system, use the show hardware command.
2	Request a RMA number from TAC by opening a support case. Open a support case by: <ul style="list-style-type: none">• Using the Create Service Request form on the iSupport page (see Contacting the Technical Assistance Center).• Contacting Dell Force10 directly by E-mail or by phone (see Contacting the Technical Assistance Center). Provide the following information when using E-mail or phone:<ul style="list-style-type: none">• Part number, description, serial number (required), Dell Service Tag (required) and chassis color (required) of the component.• Your name, organization name, telephone number, fax number, and E-mail address.• Shipping address for the replacement component, including a contact name, phone number, and E-mail address.• A description of the failure, including log messages. This can include:<ul style="list-style-type: none">– Output from the show tech-support [non-paged] command. (This report is very long so set the storage buffer in your terminal program to high.)– Output from the show logging eventlog [unit] command, where the unit is the stack ID of the member unit that experienced the failure (This report is included as a section in the output of the show tech-support [non-paged] command.)– Console captures showing the error messages– Console captures showing the troubleshooting steps taken– Saved messages to a syslog server, if you use one



Printed in the U.S.A.

www.dell.com | support.dell.com