



DSS-8+
8-port 10/100Mbps Switch
User's Guide

Rev. 03 (MAR. 2001)

6012-9830016
Printed In Taiwan



RECYCLABLE

TABLE OF CONTENTS

ABOUT THIS GUIDE	1
PURPOSE	1
OVERVIEW OF THIS USER’S GUIDE	1
INTRODUCTION	2
FAST ETHERNET TECHNOLOGY	2
SWITCHING TECHNOLOGY	2
FEATURES.....	4
UNPACKING.....	6
SETUP	6
IDENTIFYING EXTERNAL COMPONENTS	7
<i>FRONT PANEL</i>	7
LED INDICATORS.....	7
<i>REAR PANEL</i>	8
CONNECTING THE DSS-8+	10
PC TO DSS-8+	10
HUB TO DSS-8+.....	10
<i>A. 10BASE-T Hub</i>	11
<i>B. 100BASE-TX Hub</i>	11
HUB WITHOUT UPLINK (MDI-II) PORT.....	11
<i>A. Using straight cable</i>	11
<i>B. Using crossover cable</i>	11

DSS-8+ TO SWITCH (OTHER DEVICES).....	11
<i>A. Using straight cable</i>	12
<i>B. Using crossover cable</i>	12
PORT SPEED & DUPLEX MODE.....	12
INSTRUCTIONS FOR USE OF STACKING BRACKETS	13
RJ-45 PIN SPECIFICATION	14
TECHNICAL SPECIFICATIONS	16

ABOUT THIS GUIDE

Congratulations on your purchase of the DSS-8+. This device integrates 100Mbps Fast Ethernet and 10Mbps Ethernet network capabilities in a highly flexible desktop package.

Purpose

The purpose of this manual is to show you how to install and configure your DSS-8+.

Overview of this User's Guide

- ◆ Chapter 1, *Introduction*. Describes the DSS-8+ and its features.
- ◆ Chapter 2, *Unpacking and Setup*. Helps you get started with the basic installation of the DSS-8+.
- ◆ Chapter 3, *Identifying External Components*. Describes the front panel, rear panel and LED indicators of the DSS-8+.
- ◆ Chapter 4, *Connecting the DSS-8+*. Tells how you can connect the DSS-8+ to your Ethernet network.
- ◆ Appendix A, *Technical Specifications*. Lists the technical (general, physical and environmental, and performance) specifications of the DSS-8+.
- ◆ Appendix B, *RJ-45 Pin Specification*. Describes the RJ-45 receptacle/connector and the straight and crossover cable connector.

INTRODUCTION

This chapter describes the features of the DSS-8+ and some background information about Ethernet/Fast Ethernet switching technology.

Fast Ethernet Technology

The growing importance of LANs and the increasing complexity of desktop computing applications are fueling the need for high performance networks. A number of high-speed LAN technologies have been proposed to provide greater bandwidth and improve client/server response times. Among them, 100BASE-T (Fast Ethernet) provides a non-disruptive, smooth evolution from the current 10BASE-T technology. The non-disruptive and smooth evolution nature, and the dominating potential market base, virtually guarantee cost effective and high performance Fast Ethernet solutions in the years to come.

100Mbps Fast Ethernet is a new standard specified by the IEEE 802.3 LAN committee. It is an extension of the 10Mbps Ethernet standard with the ability to transmit and receive data at 100Mbps, while maintaining the CSMA/CD Ethernet protocol. Since the 100Mbps Fast Ethernet is compatible with all other 10Mbps Ethernet environments, it provides a straightforward upgrade and takes advantage of the existing investment in hardware, software, and personnel training.

Switching Technology

Another approach to pushing beyond the limits of Ethernet technology is the development of switching technology. A switch bridges

Ethernet packets at the MAC address level of the Ethernet protocol transmitting among connected Ethernet or Fast Ethernet LAN segments.

Switching is a cost-effective way of increasing the total network capacity available to users on a local area network. A switch increases capacity and decreases network loading by dividing a local area network into different *segments*, which don't compete with each other for network transmission capacity.

The DSS-8+ acts as a high-speed selective bridge between the individual segments. The DSS-8+, without interfering with any other segments, automatically forwards traffic that needs to go from one segment to another. By doing this the total network capacity is multiplied, while still maintaining the same network cabling and adapter cards.

For Fast Ethernet networks, a DSS-8+ is an effective way of eliminating problems of chaining hubs beyond the "two-repeater limit." A DSS-8+ can be used to split parts of the network into different collision domains, making it possible to expand your Fast Ethernet network beyond the 205-meter network diameter limit for 100BASE-TX networks. DSS-8+s supporting both traditional 10Mbps Ethernet and 100Mbps Fast Ethernet are also ideal for bridging between the existing 10Mbps networks and the new 100Mbps networks.

Switching LAN technology is a marked improvement over the previous generation of network bridges, which were characterized by higher latencies. Routers have also been used to segment local area networks, but the cost of a router, the setup and maintenance required make routers relatively impractical. Today switches are an ideal solution to most kinds of local area network congestion problems.

Features

The DSS-8+ was designed for easy installation and high performance in an environment where traffic on the network and the number of users increase continuously.

The DSS-8+ with its small, compact size was specifically designed for small to middle workgroups. The DSS-8+ can be installed where space is limited; moreover, the DSS-8+ provides immediate access to a rapidly growing network through a wide range of functions.

The DSS-8+ is ideal for deployment with multiple high-speed servers for shared bandwidth 10Mbps or 100Mbps workgroups. With the highest bandwidth 200Mbps (100Mbps full-duplex mode), any port can provide workstations with a congestion-free data pipe for simultaneous access to the server.

The DSS-8+ is expandable by cascading two or more DSS-8+s together. As all ports support 200Mbps, the DSS-8+ can be cascaded from any port and to any number of DSS-8+s.

The DSS-8+ is a perfect choice for sites planning to upgrade to Fast Ethernet in the future. Ethernet workgroups can connect to the DSS-8+ now, and you can change adapters and hubs anytime later without needing to change the DSS-8+s or reconfigure the network.

The DSS-8+ combines dynamic memory allocation with store-and-forward switching to ensure that the buffer is effectively allocated for each port, while controlling the data flow between the transmit and receive nodes to guarantee against all possible packet loss.

The DSS-8+ is a managed 10/100 Fast Ethernet switch that offers solutions in accelerating small Ethernet workgroup bandwidth. Other key features are:

- ◆ Uplink/ MDI-II (media dependent interface) port for uplink to another switch, hub or repeater.

- ◆ Store and forward switching scheme capability. As the result of complete frame checking and error frame filtering, this scheme prevents error packages from transmitting among segments.
- ◆ NWay Auto-negotiation for any port. This allows for auto-sensing of speed (10/100Mbps) thereby providing you with automatic and flexible solutions in your network connections.
- ◆ Flow control for any port. This minimizes dropped packets by sending out collision signals when the port's receiving buffer is full. Note that flow control is only available in half duplex mode.
- ◆ Data forwarding rate per port is at wire-speed for 100Mbps speed.
- ◆ Data forwarding rate per port is at wire-speed for 10Mbps speed.
- ◆ Data filtering rate eliminates all error packets, runts, etc., per port at wire-speed for 100Mbps speed.
- ◆ Data filtering rate eliminates all error packets, runts, etc., per port at wire-speed for 10Mbps speed.
- ◆ 16K MAC address entries table per device for the DSS-8+.
- ◆ 256 KB RAM buffer per device for the DSS-8+.
- ◆ Network looped detecting.

Unpacking and Setup

This chapter provides unpacking and setup information for the DSS-8+.

Unpacking

Open the box and carefully unpacks its contents. The box should contain the following items:

- ◆ One DSS-8+
- ◆ One external power adapter
- ◆ One pair of Stacking Brackets
- ◆ This User's Guide.

If any item is found missing or damaged, please contact your local reseller for replacement.

Setup

The setup for the DSS-8+ can be performed using the following steps:

- ◆ The surface must support at least 1.5 Kg for the DSS-8+.
 - ◆ The power outlet should be within 1.82 meters (6 feet) of the DSS-8+.
 - ◆ Visually inspect the DC power jack and make sure that it is fully secured to the power adapter.
 - ◆ Make sure that there is proper heat dissipation from and adequate ventilation around the DSS-8+. Do not place heavy objects on the DSS-8+.
-

IDENTIFYING EXTERNAL COMPONENTS

This section identifies all the major external components of the DSS-8+. Both the front and rear panels are shown followed by a description of each panel feature. The indicator panel is described in detail in the next chapter.

Front Panel

The figure below shows the front panel of the DSS-8+.

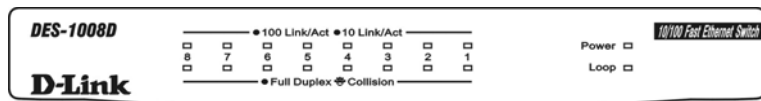

◆ LED Indicator Panel

Refer to the LED Indicator section for detailed information about each of the DSS-8+'s LED indicators.

LED Indicators

Power Indicator (PWR)

This indicator lights green when the hub is receiving power, otherwise, it is off.

Loop Detect (LOOP)

When this indicator lights amber, it means that there is a loop detected, then the network needs to be re-configuration.

Full-Duplex/Collision (Full-Duplex/Collision)

This LED indicator lights green when a respective port is in full

duplex (FDX) mode. Otherwise, it is blinking when collisions are occurring on the respective port.

100M Link/Activity, 10M Link/Activity (100M LINK/ACT(*green*), 10LINK/ACT(*amber*))

This indicator lights green when the port is connected to a 100Mbps Fast Ethernet station, if the indicator blinking green will be transmission or received data on the 100Mbps network. Otherwise, if the indicator light amber when the port is connected to a 10Mbps Ethernet station, if the indicator blinking amber will be transmission or received data on the 10Mbps network.

Rear Panel

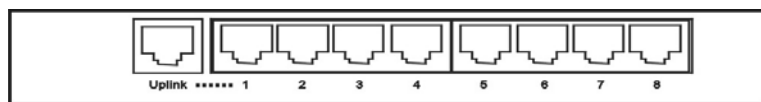

◆ **DC Power Jack:** Power is supplied through an external AC power adapter. Check the technical specification section for information about the AC power input voltage. (Power Jack is on the right side of the device)

Since the DSS-8+ does not include a power switch, plugging its power adapter into a power outlet will immediately power it on.

◆ **MDI-X Jacks:** Use these jacks to connect stations to the hub. These are **MDI-X** (Medium-Dependent Interface, Cross-wired) jacks, which mean, you can use ordinary straight-through twisted-pair cables to connect user machines and servers to the hub through them. If you need to connect another device with an **MDI-X** jack, such as

another hub or an Ethernet switch, you should use a crossover cable, or make the connection using the **MDI-X** jack (described below).

- ◆ **Uplink Jack(s) (MDI-II):** Use this jack to connect stations to the hub. This is an **MDI-II** (Medium-dependent Interface, straight-wired) jack, which means you can connect the hub to a device with an **MDI-X** port using an ordinary straight-through cable, making a crossover cable unnecessary.

CONNECTING THE DSS-8+

This chapter describes how to connect the DSS-8+ to your Fast Ethernet network. In each of the following figures, the DSS-8+ is shown.

PC to DSS-8+

A PC can be connected to DSS-8+ via a two-pair Category 3, 4, 5 UTP/STP straight cable. The PC (equipped with a RJ-45 10/100Mbps phone jack) can be connected to any of the 8 ports (1x - 8x).

The LED indicators for PC connection depend on the LAN card's capabilities. If LED indicators are not lit after making a proper connection, check the PC LAN card, the cable and the DSS-8+ conditions and connections.

The following are LED indicator possibilities for a PC to DSS-8+ connection:

1. The "100LINK/ACT,10LINK/ACT" LED indicator lights green for hookup to 100Mbps speed or light amber for hookup to 10Mbps speed.
2. The "Full-Duplex/Collision" LED indicator depends upon LAN card capabilities for full duplex or half duplex.

Hub to DSS-8+

A hub (10 or 100BASE-TX) can be connected to the DSS-8+ via a two-pair Category 3, 4, 5 UTP/STP straight cables. The connection is accomplished from the hub uplink (MDI-II) port to any of the DSS-8+ (MDI-X) ports: 1x - 8x for the DSS-8+.

A. 10BASE-T Hub

For a 10BASE-T hub, the DSS-8+ LED indicators should light up as the following:

“Full-Duplex/Collision” indicator is *OFF*.

“100LINK/ACT,10LINK/ACT LED” indicator is light amber.

B. 100BASE-TX Hub

For a 100BASE-TX hub, the DSS-8+ LED indicators should light up as the following:

“Full-Duplex/Collision” LED indicator is *OFF*.

“100LINK/ACT,10LINK/ACT” LED indicator is light green.

Hub without Uplink (MDI-II) port

If a hub is not equipped with an uplink (MDI-II) port, connection can be made using either straight cable or crossover cable.

A. Using straight cable

When using straight cable, the connection can be made from the uplink (MDI-II) port of the DSS-8+ to any port of the hub.

B. Using crossover cable

When using crossover cable, the connection can be made from any (MDI-X) ports of the DSS-8+ to any port of the Hub.

DSS-8+ to switch (other devices)

The DSS-8+ can be connected to another switch or other devices (routers, bridges, etc.) via a two-pair Category 3, 4, 5 UTP/STP straight or crossover cable.

A. Using straight cable

When using straight cable, this is done from the uplink (MDI-II) port of the DSS-8+ (DSS-8+ A) to any of the 10Mbps or 100Mbps (MDI-X) port of the other switch (switch B) or other devices.

B. Using crossover cable

When using crossover cable, this is done from any (MDI-X) port of the DSS-8+ (DSS-8+ A) to any of the 10Mbps, 100Mbps (MDI-X) port of the other switch (switch B) or other devices.

1. The “100LINK/ACT,10LINK/ACT” LED indicator light green for hookup to 100Mbps speed or light amber for hookup to 10Mbps speed.
2. The “Full-Duplex/Collision” LED indicator depends upon LAN card capabilities for full-duplex or half-duplex

Port Speed & Duplex Mode

After plugging the selected cable to a specific port, the system uses auto-negotiation to determine the transmission mode for any new twisted-pair connection:

If the attached device does not support auto-negotiation or has auto-negotiation disabled, an auto-sensing process is initiated to select the speed and set the duplex mode to **half-duplex**.

INSTRUCTIONS FOR USE OF STACKING BRACKETS

First, make sure you have one pair of stacking brackets for each device.

Next, slide one bracket onto each end of the device as shown in the diagram below. Be sure each bracket is positioned correctly.

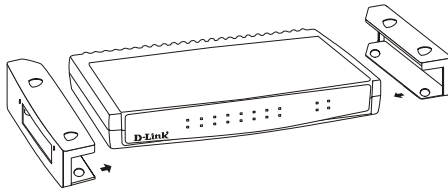

Note when clicking each bracket into place, the round feet on the bottom of the device will line up with the round holes on the bracket. The brackets are designed to fit snugly in place. Please do not force them.

The brackets are now ready for stacking devices. See the diagram below.

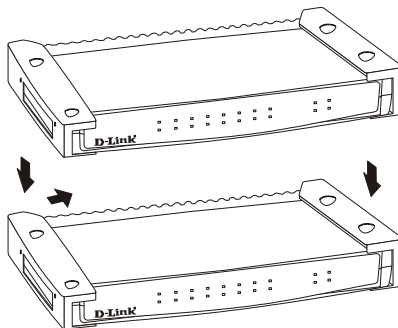

RJ-45 PIN SPECIFICATION

When connecting your DSS-8+ to another switch, a bridge or a hub, a modified crossover cable is necessary. Please review these products for matching cable pin assignment.

The following diagram and tables show the standard RJ-45 receptacle/connector and their pin assignments for the switch-to-network adapter card connection, and the straight / crossover cable for the DSS-8+-to-switch/hub/bridge connection.

RJ-45 Connector pin assignment	
Contact	Media Direct Interface Signal
1	TX + (transmit)
2	TX - (transmit)
3	Rx + (receive)
4	Not used
5	Not used
6	Rx - (receive)
7	Not used
8	Not used

The standard cable, RJ-45 pin assignment

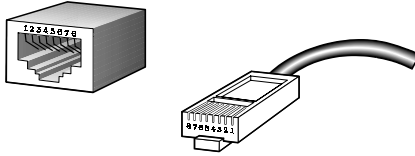

The standard RJ-45 receptacle/connector

The following shows straight cable and crossover cable connection:

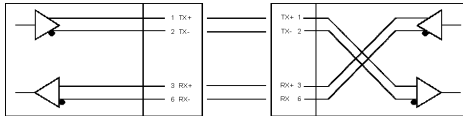

Straight cable for DSS-8+ (uplink MDI-II port) to switch/Hub or other devices connection

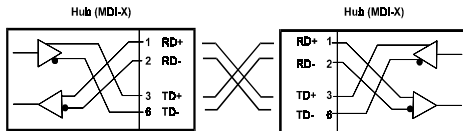

Crossover cable for DSS-8+ (MDI-X port) to switch/hub or other network devices (MDI-X port) connection

TECHNICAL SPECIFICATIONS

General	
Standards	IEEE 802.3 10BASE-T Ethernet IEEE 802.3u 100BASE-TX Fast Ethernet ANSI/IEEE Std. 802.3 NWay Auto-negotiation
Protocol	CSMA/CD
Data Transfer Rate	Ethernet: 10Mbps (half duplex), 20Mbps (full-duplex) Fast Ethernet: 100Mbps (half duplex), 200Mbps (full- duplex)
Topology	Star
Network Cables	10BASE-T: 2-pair UTP Cat. 3,4,5 (100 m), EIA/TIA- 568 100-ohm STP (100 m) 100BASE-TX: 2-pair UTP Cat. 5 (100 m), EIA/TIA-568 100-ohm STP (100 m)
Number of Ports	8 x 10/100Mbps NWay ports
Uplink Port	MDI-II RJ-45 shared with port * 1, share with port 1

Physical and Environmental	
DC inputs	DC7.5V/1.5A
Power Consumption	11.25 watts. (max.)
Temperature	Operating: 0° ~ 50° C, Storage: -10° ~ 70° C
Humidity	Operating: 10% ~ 90%, Storage: 5% ~ 90%
Dimensions	190 x116 x 32 mm (W x H x D)
EMI:	FCC Class B, CE Mark B, VCCI-II
Performance	
Transmission Method:	Store-and-forward
RAM Buffer:	256KBytes per device
Filtering Address Table:	16K entries per device
Packet Filtering/Forwarding Rate:	10Mbps Ethernet: 14,880/pps 100Mbps Fast Ethernet: 148,800/pps
MAC Address Learning:	Automatic update

FCC Certifications

This equipment has been tested and found to comply with the limits for a Class B digital device, pursuant to Part 15 of the FCC Rules. These limits are designed to provide reasonable protection against harmful interference in a residential installation. This equipment generates, uses and can radiate radio frequency energy and, if not installed and used in accordance with the instructions, may cause harmful interference to radio communications. However, there is no guarantee that interference will not occur in a particular installation. If this equipment does cause harmful interference to radio or television reception, which can be determined by turning the equipment off and on, the user is encouraged to try to correct the interference by one or more of the following measures:

- Reorient or relocate the receiving antenna.
- Increase the separation between the equipment and receiver.
- Connect the equipment into an outlet on a circuit different from that to which the receiver is connected.
- Consult the dealer or an experienced radio/TV technician for help.

Shielded interface cables must be used in order to comply with emission limits.

You are cautioned that changes or modifications not expressly approved by the party responsible for compliance could void your authority to operate the equipment.

This device complies with Part 15 of the FCC rules. Operation is subject to the following two conditions: (1) This device may not cause harmful interference, and (2)

This device must accept any interference received, including interference that may cause undesired operation.

CE Mark Warning

This is a Class B product. In a domestic environment, this product may cause radio interference, in which case the user may be required to take adequate measures.

VCCI Warning

注意

この装置は、情報処理装置等電波障害自主規制協議会(VCCI)の基準に基づく第一種情報技術装置です。この装置を家庭環境で使用すると電波妨害を引き起こすことがあります。この場合には使用者が適切な対策を講ずるよう要求されることがあります。

LIMITED WARRANTY

D-Link provides this limited warranty for its product only to the person or entity who originally purchased the product from D-Link or its authorized reseller or distributor.

Limited Hardware Warranty: D-Link warrants that the hardware portion of the D-Link products described below (“Hardware”) will be free from material defects in workmanship and materials from the date of original retail purchase of the Hardware, for the period set forth below applicable to the product type (“Warranty Period”) if the Hardware is used and serviced in accordance with applicable documentation; provided that a completed Registration Card is returned to an Authorized D-Link Service Office within ninety (90) days after the date of original retail purchase of the Hardware. If a completed Registration Card is not received by an authorized D-Link Service Office within such ninety (90) period, then the Warranty Period shall be ninety (90) days from the date of purchase.

<i>Product Type</i>	<i>Warranty Period</i>
Product (excluding power supplies and fans)	One (1) Year
Power Supplies and Fans	One (1) Year
Spare parts and spare kits	Ninety (90) days

D-Link’s sole obligation shall be to repair or replace the defective Hardware at no charge to the original owner. Such repair or replacement will be rendered by D-Link at an Authorized D-Link Service Office. The replacement Hardware need not be new or of an identical make, model or part; D-Link may in its discretion may replace the defective Hardware (or any part thereof) with any reconditioned product that D-Link reasonably determines is substantially equivalent (or superior) in all material respects to the defective Hardware. The Warranty Period shall extend for an additional ninety (90) days after any repaired or replaced Hardware is delivered. If a material defect is incapable of correction, or if D-Link determines in its sole discretion that it is not practical to repair or replace the defective Hardware, the price paid by the original purchaser for the defective Hardware will be refunded by D-Link upon return to D-Link of the defective Hardware. All Hardware (or part thereof) that is replaced by D-Link, or for which the purchase price is refunded, shall become the property of D-Link upon replacement or refund.

Limited Software Warranty: D-Link warrants that the software portion of the product (“Software”) will substantially conform to D-Link’s then current functional specifications for the Software, as set forth in the applicable documentation, from the date of original delivery of the Software for a period of ninety (90) days (“Warranty Period”), if the Software is properly installed on approved hardware and operated as contemplated in its documentation. D-Link further warrants that, during the Warranty Period, the magnetic media on which D-Link delivers the Software will be free of physical defects. D-Link’s sole obligation shall be to replace the non-conforming Software (or defective media) with software that substantially conforms to D-Link’s functional specifications for the Software. Except as otherwise agreed by D-Link in writing, the replacement Software is provided only to the original licensee, and is subject to the terms and conditions of the license granted by D-Link for the Software. The Warranty Period shall extend for an additional ninety (90) days after any replacement Software is delivered. If a material non-conformance is incapable of correction, or if D-Link determines in its sole discretion that it is not practical to replace the non-conforming Software, the price paid by the original licensee for the non-conforming Software will be refunded by D-Link; provided that the non-conforming Software (and all copies thereof) is first returned to D-Link. The license granted respecting any Software for which a refund is given automatically terminates.

What You Must Do For Warranty Service:

Registration Card. The Registration Card provided at the back of this manual must be completed and returned to an Authorized D-Link Service Office for each D-Link product within ninety (90) days after the product is purchased and/or licensed. The addresses/telephone/fax list of the nearest Authorized D-Link Service Office is provided in the back of this manual. FAILURE TO PROPERLY COMPLETE AND TIMELY RETURN THE REGISTRATION CARD MAY AFFECT THE WARRANTY FOR THIS PRODUCT.

Submitting A Claim. Any claim under this limited warranty must be submitted in writing before the end of the Warranty Period to an Authorized D-Link Service Office. The claim must include a written description of the Hardware defect or Software nonconformance in sufficient detail to allow D-Link to confirm the same. The original product owner must obtain a Return Material Authorization (RMA) number from the Authorized D-Link Service

Office and, if requested, provide written proof of purchase of the product (such as a copy of the dated purchase invoice for the product) before the warranty service is provided. After an RMA number is issued, the defective product must be packaged securely in the original or other suitable shipping package to ensure that it will not be damaged in transit, and the RMA number must be prominently marked on the outside of the package. The packaged product shall be insured and shipped to D-Link, 53 Discovery Drive, Irvine CA 92618, with all shipping costs prepaid. D-Link may reject or return any product that is not packaged and shipped in strict compliance with the foregoing requirements, or for which an RMA number is not visible from the outside of the package. The product owner agrees to pay D-Link's reasonable handling and return shipping charges for any product that is not packaged and shipped in accordance with the foregoing requirements, or that is determined by D-Link not to be defective or non-conforming.

What Is Not Covered:

This limited warranty provided by D-Link does not cover:

Products that have been subjected to abuse, accident, alteration, modification, tampering, negligence, misuse, faulty installation, lack of reasonable care, repair or service in any way that is not contemplated in the documentation for the product, or if the model or serial number has been altered, tampered with, defaced or removed;

Initial installation, installation and removal of the product for repair, and shipping costs;

Operational adjustments covered in the operating manual for the product, and normal maintenance;

Damage that occurs in shipment, due to act of God, failures due to power surge, and cosmetic damage; and

Any hardware, software, firmware or other products or services provided by anyone other than D-Link.

Disclaimer of Other Warranties: EXCEPT FOR THE LIMITED WARRANTY SPECIFIED HEREIN, THE PRODUCT IS PROVIDED "AS-IS" WITHOUT ANY WARRANTY OF ANY KIND INCLUDING, WITHOUT LIMITATION, ANY WARRANTY OF MERCHANTABILITY, FITNESS

FOR A PARTICULAR PURPOSE AND NON-INFRINGEMENT. IF ANY IMPLIED WARRANTY CANNOT BE DISCLAIMED IN ANY TERRITORY WHERE A PRODUCT IS SOLD, THE DURATION OF SUCH IMPLIED WARRANTY SHALL BE LIMITED TO NINETY (90) DAYS. EXCEPT AS EXPRESSLY COVERED UNDER THE LIMITED WARRANTY PROVIDED HEREIN, THE ENTIRE RISK AS TO THE QUALITY, SELECTION AND PERFORMANCE OF THE PRODUCT IS WITH THE PURCHASER OF THE PRODUCT.

Limitation of Liability: TO THE MAXIMUM EXTENT PERMITTED BY LAW, D-LINK IS NOT LIABLE UNDER ANY CONTRACT, NEGLIGENCE, STRICT LIABILITY OR OTHER LEGAL OR EQUITABLE THEORY FOR ANY LOSS OF USE OF THE PRODUCT, INCONVENIENCE OR DAMAGES OF ANY CHARACTER, WHETHER DIRECT, SPECIAL, INCIDENTAL OR CONSEQUENTIAL (INCLUDING, BUT NOT LIMITED TO, DAMAGES FOR LOSS OF GOODWILL, WORK STOPPAGE, COMPUTER FAILURE OR MALFUNCTION, LOSS OF INFORMATION OR DATA CONTAINED IN, STORED ON, OR INTEGRATED WITH ANY PRODUCT RETURNED TO D-LINK FOR WARRANTY SERVICE) RESULTING FROM THE USE OF THE PRODUCT, RELATING TO WARRANTY SERVICE, OR ARISING OUT OF ANY BREACH OF THIS LIMITED WARRANTY, EVEN IF D-LINK HAS BEEN ADVISED OF THE POSSIBILITY OF SUCH DAMAGES. THE SOLE REMEDY FOR A BREACH OF THE FOREGOING LIMITED WARRANTY IS REPAIR, REPLACEMENT OR REFUND OF THE DEFECTIVE OR NON-CONFORMING PRODUCT.

GOVERNING LAW: This Limited Warranty shall be governed by the laws of the state of California.

Some states do not allow exclusion or limitation of incidental or consequential damages, or limitations on how long an implied warranty lasts, so the foregoing limitations and exclusions may not apply. This limited warranty provides specific legal rights and the product owner may also have other rights which vary from state to state.

Trademarks

Copyright ©1999 D-Link Corporation. Contents subject to change without prior notice. D-Link is a registered trademark of D-Link Corporation/D-Link Systems, Inc. All other trademarks belong to their respective proprietors.

Copyright Statement

No part of this publication may be reproduced in any form or by any means or used to make any derivative such as translation, transformation, or adaptation without permission from D-Link Corporation/D-Link Systems Inc., as stipulated by the United States Copyright Act of 1976.