



Preface

This preface describes the audience, organization, and conventions of the *Catalyst 4500 E-Series Switches Installation Guide* and provides information on how to obtain related documentation and technical assistance.

Audience

This guide is intended for technicians who will install a Catalyst 4500 E-series switch in a wiring closet rack. Only trained and qualified service personnel (as defined in IEC 60950 and AS/NZS3260) should install, replace, or service the equipment.

Organization

This publication is organized as follows:

Chapter	Title	Description
Chapter 1	Product Overview	Lists and describes the hardware features, components, interfaces, and specifications of the Catalyst 4500 E-series switches. The chapter also contains illustrations of the chassis.
Chapter 2	Preparing for Installation	Describes how to prepare your site for the installation of the switch.
Chapter 3	Installing the Switch	Describes how to install the Catalyst 4500 E-series switches in an equipment rack.
Chapter 4	Removal and Replacement Procedures	Describes how to remove and replace field-replaceable units (FRUs) such as power supplies and fan trays.
Chapter 5	Troubleshooting	Provides troubleshooting guidelines for the initial hardware installation and suggests steps to help isolate and resolve problems.
Appendix A	Power Supply Specifications	Provides illustrations and specification tables for the available Catalyst 4500 E-series switch AC-input and DC-input power supplies. Illustrations and specification tables are also provided for the supported AC power cords.

Chapter	Title	Description
Appendix B	Repacking a Switch	Provides instructions for repacking your Catalyst 4500 E-series switch in the event that you need to move the chassis or have to return it to the factory.
Appendix C	Initial Configuration for the Switch	Provides a very minimal configuration process. For full configuration of features and interfaces, refer to the software configuration guide for your software release.

Conventions

This document uses the following conventions:

Convention	Description
boldface font	Commands, command options, and keywords are in boldface .
<i>italic font</i>	Arguments for which you supply values are in <i>italics</i> .
[]	Elements in square brackets are optional.
{ x y z }	Alternative keywords are grouped in braces and separated by vertical bars.
[x y z]	Optional alternative keywords are grouped in brackets and separated by vertical bars.
string	A nonquoted set of characters. Do not use quotation marks around the string or the string will include the quotation marks.
screen font	Terminal sessions and information the system displays are in screen font.
boldface screen font	Information you must enter is in boldface screen font .
<i>italic screen font</i>	Arguments for which you supply values are in <i>italic screen font</i> .
^	The symbol ^ represents the key labeled Control. For example, the key combination ^D in a screen display means hold down the Control key while you press the D key.
< >	Nonprinting characters, such as passwords, are in angle brackets.

Notes use the following conventions:



Note

Means *reader take note*. Notes contain helpful suggestions or references to material not covered in the publication.

Cautions use the following conventions:



Caution

Means *reader be careful*. In this situation, you might do something that could result in equipment damage or loss of data.

Warnings use the following conventions:

Statement 1071—Warning Definition



Warning

IMPORTANT SAFETY INSTRUCTIONS

This warning symbol means danger. You are in a situation that could cause bodily injury. Before you work on any equipment, be aware of the hazards involved with electrical circuitry and be familiar with standard practices for preventing accidents. Use the statement number provided at the end of each warning to locate its translation in the translated safety warnings that accompanied this device. Statement 1071

SAVE THESE INSTRUCTIONS

Waarschuwing

BELANGRIJKE VEILIGHEIDSINSTRUCTIES

Dit waarschuwingssymbool betekent gevaar. U verkeert in een situatie die lichamelijk letsel kan veroorzaken. Voordat u aan enige apparatuur gaat werken, dient u zich bewust te zijn van de bij elektrische schakelingen betrokken risico's en dient u op de hoogte te zijn van de standaard praktijken om ongelukken te voorkomen. Gebruik het nummer van de verklaring onderaan de waarschuwing als u een vertaling van de waarschuwing die bij het apparaat wordt geleverd, wilt raadplegen.

BEWAAR DEZE INSTRUCTIES

Varoitus

TÄRKEITÄ TURVALLISUUSOHJEITA

Tämä varoitusmerkki merkitsee vaaraa. Tilanne voi aiheuttaa ruumiillisia vammoja. Ennen kuin käsittelet laitteistoa, huomioi sähköpiirien käsittelemiseen liittyvät riskit ja tutustu onnettomuuksien yleisiin ehkäisytapoihin. Turvallisuusvaroitusten käännökset löytyvät laitteen mukana toimitettujen käännettyjen turvallisuusvaroitusten joukosta varoitusten lopussa näkyvien lausuntonumeroiden avulla.

SÄILYTÄ NÄMÄ OHJEET

Attention

IMPORTANTES INFORMATIONS DE SÉCURITÉ

Ce symbole d'avertissement indique un danger. Vous vous trouvez dans une situation pouvant entraîner des blessures ou des dommages corporels. Avant de travailler sur un équipement, soyez conscient des dangers liés aux circuits électriques et familiarisez-vous avec les procédures couramment utilisées pour éviter les accidents. Pour prendre connaissance des traductions des avertissements figurant dans les consignes de sécurité traduites qui accompagnent cet appareil, référez-vous au numéro de l'instruction situé à la fin de chaque avertissement.

CONSERVEZ CES INFORMATIONS

Warnung WICHTIGE SICHERHEITSHINWEISE

Dieses Warnsymbol bedeutet Gefahr. Sie befinden sich in einer Situation, die zu Verletzungen führen kann. Machen Sie sich vor der Arbeit mit Geräten mit den Gefahren elektrischer Schaltungen und den üblichen Verfahren zur Vorbeugung vor Unfällen vertraut. Suchen Sie mit der am Ende jeder Warnung angegebenen Anweisungsnummer nach der jeweiligen Übersetzung in den übersetzten Sicherheitshinweisen, die zusammen mit diesem Gerät ausgeliefert wurden.

BEWAHREN SIE DIESE HINWEISE GUT AUF.

Avvertenza IMPORTANTI ISTRUZIONI SULLA SICUREZZA

Questo simbolo di avvertenza indica un pericolo. La situazione potrebbe causare infortuni alle persone. Prima di intervenire su qualsiasi apparecchiatura, occorre essere al corrente dei pericoli relativi ai circuiti elettrici e conoscere le procedure standard per la prevenzione di incidenti. Utilizzare il numero di istruzione presente alla fine di ciascuna avvertenza per individuare le traduzioni delle avvertenze riportate in questo documento.

CONSERVARE QUESTE ISTRUZIONI

Advarsel VIKTIGE SIKKERHETSINSTRUKSJONER

Dette advarselssymbolet betyr fare. Du er i en situasjon som kan føre til skade på person. Før du begynner å arbeide med noe av utstyret, må du være oppmerksom på farene forbundet med elektriske kretser, og kjenne til standardprosedyrer for å forhindre ulykker. Bruk nummeret i slutten av hver advarsel for å finne oversettelsen i de oversatte sikkerhetsadvarslene som fulgte med denne enheten.

TA VARE PÅ DISSE INSTRUKSJONENE

Aviso INSTRUÇÕES IMPORTANTES DE SEGURANÇA

Este símbolo de aviso significa perigo. Você está em uma situação que poderá ser causadora de lesões corporais. Antes de iniciar a utilização de qualquer equipamento, tenha conhecimento dos perigos envolvidos no manuseio de circuitos elétricos e familiarize-se com as práticas habituais de prevenção de acidentes. Utilize o número da instrução fornecido ao final de cada aviso para localizar sua tradução nos avisos de segurança traduzidos que acompanham este dispositivo.

GUARDE ESTAS INSTRUÇÕES

¡Advertencia! INSTRUCCIONES IMPORTANTES DE SEGURIDAD

Este símbolo de aviso indica peligro. Existe riesgo para su integridad física. Antes de manipular cualquier equipo, considere los riesgos de la corriente eléctrica y familiarícese con los procedimientos estándar de prevención de accidentes. Al final de cada advertencia encontrará el número que le ayudará a encontrar el texto traducido en el apartado de traducciones que acompaña a este dispositivo.

GUARDE ESTAS INSTRUCCIONES

Varning! VIKTIGA SÄKERHETSANVISNINGAR

Denna varningssignal signalerar fara. Du befinner dig i en situation som kan leda till personskada. Innan du utför arbete på någon utrustning måste du vara medveten om farorna med elkretsar och känna till vanliga förfaranden för att förebygga olyckor. Använd det nummer som finns i slutet av varje varning för att hitta dess översättning i de översatta säkerhetsvarningar som medföljer denna anordning.

SPARA DESSA ANVISNINGAR**Figyelem FONTOS BIZTONSÁGI ELOÍRÁSOK**

Ez a figyelmeztető jel veszélyre utal. Sérülésveszélyt rejtő helyzetben van. Mielőtt bármely berendezésen munkát végezte, legyen figyelemmel az elektromos áramkörök okozta kockázatokra, és ismerkedjen meg a szokásos balesetvédelmi eljárásokkal. A kiadványban szereplő figyelmeztetések fordítása a készülékhez mellékelt biztonsági figyelmeztetések között található; a fordítás az egyes figyelmeztetések végén látható szám alapján kereshető meg.

ORIZZE MEG EZEKET AZ UTASÍTÁSOKAT!**Предупреждение ВАЖНЫЕ ИНСТРУКЦИИ ПО СОБЛЮДЕНИЮ ТЕХНИКИ БЕЗОПАСНОСТИ**

Этот символ предупреждения обозначает опасность. То есть имеет место ситуация, в которой следует опасаться телесных повреждений. Перед эксплуатацией оборудования выясните, каким опасностям может подвергаться пользователь при использовании электрических цепей, и ознакомьтесь с правилами техники безопасности для предотвращения возможных несчастных случаев. Воспользуйтесь номером заявления, приведенным в конце каждого предупреждения, чтобы найти его переведенный вариант в переводе предупреждений по безопасности, прилагаемом к данному устройству.

СОХРАНИТЕ ЭТИ ИНСТРУКЦИИ**警告 重要的安全性说明**

此警告符号代表危险。您正处于可能受到严重伤害的工作环境中。在您使用设备开始工作之前，必须充分意识到触电的危险，并熟练掌握防止事故发生的标准工作程序。请根据每项警告结尾提供的声明号码来找到此设备的安全性警告说明的翻译文本。

请保存这些安全性说明

警告 安全上の重要な注意事項

「危険」の意味です。人身事故を予防するための注意事項が記述されています。装置の取り扱い作業を行うときは、電気回路の危険性に注意し、一般的な事故防止策に留意してください。警告の各国語版は、各注意事項の番号を基に、装置に付属の「Translated Safety Warnings」を参照してください。

これらの注意事項を保管しておいてください。

주의 **중요 안전 지침**

이 경고 기호는 위험을 나타냅니다. 작업자가 신체 부상을 일으킬 수 있는 위험한 환경에 있습니다. 장비에 작업을 수행하기 전에 전기 회로와 관련된 위험을 숙지하고 표준 작업 관례를 숙지하여 사고를 방지하십시오. 각 경고의 마지막 부분에 있는 경고문 번호를 참조하여 이 장치와 함께 제공되는 번역된 안전 경고문에서 해당 번역문을 찾으십시오.

이 지시 사항을 보관하십시오.

Aviso **INSTRUÇÕES IMPORTANTES DE SEGURANÇA**

Este símbolo de aviso significa perigo. Você se encontra em uma situação em que há risco de lesões corporais. Antes de trabalhar com qualquer equipamento, esteja ciente dos riscos que envolvem os circuitos elétricos e familiarize-se com as práticas padrão de prevenção de acidentes. Use o número da declaração fornecido ao final de cada aviso para localizar sua tradução nos avisos de segurança traduzidos que acompanham o dispositivo.

GUARDE ESTAS INSTRUÇÕES**Advarsel** **VIGTIGE SIKKERHEDSANVISNINGER**

Dette advarselssymbol betyder fare. Du befinder dig i en situation med risiko for legemesbeskadigelse. Før du begynder arbejde på udstyr, skal du være opmærksom på de involverede risici, der er ved elektriske kredsløb, og du skal sætte dig ind i standardprocedurer til undgåelse af ulykker. Brug erklæringsnummeret efter hver advarsel for at finde oversættelsen i de oversatte advarsler, der fulgte med denne enhed.

GEM DISSE ANVISNINGER**تحذير****إرشادات الأمان الهامة**

يوضح رمز التحذير هذا وجود خطر. وهذا يعني أنك متواجد في مكان قد ينتج عنه التعرض لإصابات. قبل بدء العمل، احذر مخاطر التعرض للصدمات الكهربائية وكن على علم بالإجراءات القياسية للحيلولة دون وقوع أي حوادث. استخدم رقم البيان الموجود في آخر كل تحذير لتحديد مكان ترجمته داخل تحذيرات الأمان المترجمة التي تأتي مع الجهاز. قم بحفظ هذه الإرشادات

Upozorenje **VAŽNE SIGURNOSNE NAPOMENE**

Ovaj simbol upozorenja predstavlja opasnost. Nalazite se u situaciji koja može prouzročiti tjelesne ozljede. Prije rada s bilo kojim uređajem, morate razumjeti opasnosti vezane uz električne sklopove, te biti upoznati sa standardnim načinima izbjegavanja nesreća. U prevedenim sigurnosnim upozorenjima, priloženima uz uređaj, možete prema broju koji se nalazi uz pojedino upozorenje pronaći i njegov prijevod.

SAČUVAJTE OVE UPUTE

Upozornění DŮLEŽITÉ BEZPEČNOSTNÍ POKYNY

Tento upozorňující symbol označuje nebezpečí. Jste v situaci, která by mohla způsobit nebezpečí úrazu. Před prací na jakémkoliv vybavení si uvědomte nebezpečí související s elektrickými obvody a seznamte se se standardními opatřeními pro předcházení úrazům. Podle čísla na konci každého upozornění vyhledejte jeho překlad v přeložených bezpečnostních upozorněních, která jsou přiložena k zařízení.

USCHOVEJTE TYTO POKYNY**Προειδοποίηση ΣΗΜΑΝΤΙΚΕΣ ΟΔΗΓΙΕΣ ΑΣΦΑΛΕΙΑΣ**

Αυτό το προειδοποιητικό σύμβολο σημαίνει κίνδυνο. Βρίσκεστε σε κατάσταση που μπορεί να προκαλέσει τραυματισμό. Πριν εργαστείτε σε οποιοδήποτε εξοπλισμό, να έχετε υπόψη σας τους κινδύνους που σχετίζονται με τα ηλεκτρικά κυκλώματα και να έχετε εξοικειωθεί με τις συνήθεις πρακτικές για την αποφυγή ατυχημάτων. Χρησιμοποιήστε τον αριθμό δήλωσης που παρέχεται στο τέλος κάθε προειδοποίησης, για να εντοπίσετε τη μετάφρασή της στις μεταφρασμένες προειδοποιήσεις ασφαλείας που συνοδεύουν τη συσκευή.

ΦΥΛΑΞΤΕ ΑΥΤΕΣ ΤΙΣ ΟΔΗΓΙΕΣ**אזהרה****הוראות בטיחות חשובות**

סימן אזהרה זה מסמל סכנה. אתה נמצא במצב העלול לגרום לפציעה. לפני שתעבוד עם ציוד כלשהו, עליך להיות מודע לסכנות הכרוכות במעגלים חשמליים ולהכיר את הנהלים המקובלים למניעת תאונות. השתמש במספר ההוראה המסופק בסופה של כל אזהרה כדי לאתר את התרגום באזהרות הבטיחות המתורגמות שמצורפות להתקן.

שמור הוראות אלה**ВАЖНИ БЕЗБЕДНОСНИ НАПАТСТВИЈА**

Симболот за предупредување значи опасност. Се наоѓате во ситуација што може да предизвика телесни повреди. Пред да работите со опремата, бидете свесни за ризикот што постои кај електричните кола и треба да ги познавате стандардните постапки за спречување на несреќни случаи. Искористете го бројот на изјавата што се наоѓа на крајот на секое предупредување за да го најдете неговиот период во преведените безбедносни предупредувања што се испорачани со уредот.

ЧУВАЈТЕ ГИ ОБИЕ НАПАТСТВИЈА**Ostrzeżenie WAŻNE INSTRUKCJE DOTYCZĄCE BEZPIECZEŃSTWA**

Ten symbol ostrzeżenia oznacza niebezpieczeństwo. Zachodzi sytuacja, która może powodować obrażenia ciała. Przed przystąpieniem do prac przy urządzeniach należy zapoznać się z zagrożeniami związanymi z układami elektrycznymi oraz ze standardowymi środkami zapobiegania wypadkom. Na końcu każdego ostrzeżenia podano numer, na podstawie którego można odszukać tłumaczenie tego ostrzeżenia w dołączonym do urządzenia dokumencie z tłumaczeniami ostrzeżeń.

NINIEJSZE INSTRUKCJE NALEŻY ZACHOWAĆ

Upozornenie DŔLEŽITÉ BEZPEČNOSTNÉ POKYNY

Tento varovný symbol označuje nebezpečenstvo. Nachádzate sa v situácii s nebezpečenstvom úrazu. Pred prácou na akomkoľvek vybavení si uvedomte nebezpečenstvo súvisiace s elektrickými obvodmi a oboznámte sa so štandardnými opatreniami na predchádzanie úrazom. Podľa čísla na konci každého upozornenia vyhľadajte jeho preklad v preložených bezpečnostných upozorneniach, ktoré sú priložené k zariadeniu.

USCHOVAJTE SI TENTO NÁVOD**Opozorilo POMEMBNI VARNOSTNI NAPOTKI**

Ta opozorilni simbol pomeni nevarnost. Nahajate se v situaciji, kjer lahko pride do telesnih poškodb. Preden pričnete z delom na napravi, se morate zavedati nevarnosti udara električnega toka, ter tudi poznati preventivne ukrepe za preprečevanje takšnih nevarnosti. Uporabite obrazložitevno številko na koncu posameznega opozorila, da najdete opis nevarnosti v priloženem varnostnem priročniku.

SHRANITE TE NAPOTKE!**警告****重要安全性指示**

此警告符號代表危險，表示可能造成人身傷害。使用任何設備前，請留心電路相關危險，並熟悉避免意外的標準作法。您可以使用每項警告後的聲明編號，查詢本裝置隨附之安全性警告譯文中的翻譯。請妥善保留此指示

Related Documentation

Although their release notes are unique, the Catalyst 4500, Catalyst 4900, Catalyst ME 4900, and Catalyst 4900M platforms use the same software configuration guide, command reference guide, and system message guide. Refer to the following home pages for additional information:

- Catalyst 4500 Series Switch Documentation Home
<http://www.cisco.com/go/cat4500/docs>
- Catalyst 4900 Series Switch Documentation Home
<http://www.cisco.com/go/cat4900/docs>
- Cisco ME 4900 Series Ethernet Switches Documentation Home
http://www.cisco.com/en/US/products/ps7009/tsd_products_support_series_home.html

Hardware Documents

Installation guides and notes including specifications and relevant safety information are available at the following URLs:

- *Catalyst 4500 Series Switches Installation Guide*
<http://www.cisco.com/en/US/docs/switches/lan/catalyst4500/hardware/installation/guide/78-14409-08/4500inst.html>
- *Catalyst 4500 E-series Switches Installation Guide*
<http://www.cisco.com/en/US/docs/switches/lan/catalyst4500/hardware/catalyst4500e/installation/guide/Eseries.html>
- For information about individual switching modules and supervisors, refer to the *Catalyst 4500 Series Module Installation Guide* at:
http://www.cisco.com/c/en/us/td/docs/switches/lan/catalyst4500/hardware/configuration/notes/OL_25315.html
- *Regulatory Compliance and Safety Information for the Catalyst 4500 Series Switches*
http://www.cisco.com/c/en/us/td/docs/switches/lan/catalyst4500/hardware/regulatory/compliance/78_13233.html
- Installation notes for specific supervisor engines or for accessory hardware
http://www.cisco.com/en/US/products/hw/switches/ps4324/prod_installation_guides_list.html
- Catalyst 4900 and Catalyst 4900M hardware installation information is available at:
http://www.cisco.com/en/US/products/ps6021/prod_installation_guides_list.html
- Cisco ME 4900 Series Ethernet Switches installation information
http://www.cisco.com/en/US/products/ps7009/prod_installation_guides_list.html

Software Documentation

Software release notes, configuration guides, command references, and system message guides are available at the following URLs:

- Catalyst 4500 Series release notes
<http://www.cisco.com/c/en/us/support/switches/catalyst-4500-series-switches/products-release-notes-list.html>
- Catalyst 4948 Series and Catalyst 4948E release notes
http://www.cisco.com/en/US/products/ps6021/prod_release_notes_list.html
- Cisco ME 4900 Series Ethernet Switch release notes
http://www.cisco.com/en/US/docs/switches/lan/catalyst4500/release/note/OL_11511.html

Software documents for the Catalyst 4500 Classic, Catalyst 4500 E-Series, Catalyst 4900, and Cisco ME 4900 Series Ethernet Switches

- *Catalyst 4500 Series Software Configuration Guide*
<http://www.cisco.com/c/en/us/support/switches/catalyst-4500-series-switches/products-installation-and-configuration-guides-list.html>
- *Catalyst 4500 Series Software Command Reference*
http://www.cisco.com/en/US/products/hw/switches/ps4324/prod_command_reference_list.html
- *Catalyst 4500 Series Software System Message Guide*
<http://www.cisco.com/c/en/us/support/switches/catalyst-4500-series-switches/products-system-message-guides-list.html>

Cisco IOS Documentation

Platform-independent Cisco IOS documentation may also apply to the Catalyst 4500 and 4900 switches. These documents are available at the following URLs:

- Cisco IOS configuration guides, Release 12.x
http://www.cisco.com/en/US/products/ps6350/products_installation_and_configuration_guides_list.html
- Cisco IOS command references, Release 12.x
http://www.cisco.com/en/US/products/ps6350/prod_command_reference_list.html
Command Lookup Tool
<http://tools.cisco.com/Support/CLILookup/cltSearchAction.do>
- Cisco IOS system messages, version 12.x
http://www.cisco.com/en/US/products/ps6350/products_system_message_guides_list.html
Error Message Decoder tool
<http://www.cisco.com/cgi-bin/Support/Errordecoder/index.cgi>
- MIB information
<http://www.cisco.com/public/sw-center/netmgmt/cmtk/mibs.shtml>

Obtain Documentation and Submit a Service Request

For information on obtaining documentation, using the Cisco Bug Search Tool (BST), submitting a service request, and gathering additional information, see *What's New in Cisco Product Documentation*.

To receive new and revised Cisco technical content directly to your desktop, you can subscribe to the [What's New in Cisco Product Documentation RSS feed](#). The RSS feeds are a free service.



CHAPTER 1

Product Overview

Revised: 08 August 2017

This chapter describes the Catalyst 4500 E-series switches and contains these sections:

- [Catalyst 4503-E Switch, page 1-2](#)
- [Catalyst 4506-E Switch, page 1-6](#)
- [Catalyst 4507R-E Switch, page 1-10](#)
- [Catalyst 4510R-E Switch, page 1-14](#)
- [Catalyst 4507R+E Switch, page 1-18](#)
- [Catalyst 4510R+E Switch, page 1-22](#)



Note

The Catalyst 4500 series switches are described in a separate publication.



Tip

For additional information about the Cisco Catalyst 4500 E-series switches (including configuration examples and troubleshooting information), see the documents listed on this page:

<http://www.cisco.com/en/US/products/hw/switches/ps4324/index.html>

Catalyst 4503-E Switch

The Catalyst 4503-E switch is a 3-slot horizontal chassis supporting redundant power supplies, a single supervisor engine, and slots for up to two modules. [Figure 1-1](#) shows a front view of the Catalyst 4503-E switch with the chassis major features identified.

Figure 1-1 Catalyst 4503-E Switch Chassis (Front View)

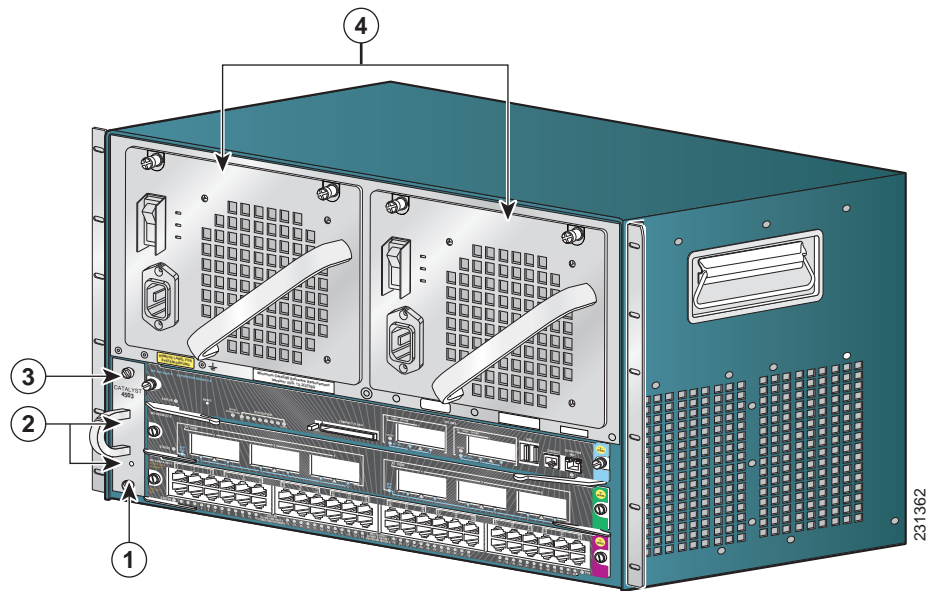

1	Fan tray assembly	3	Supervisor engine (slot 1)
2	Switching modules (slots 2 and 3)	4	Redundant power supplies

Table 1-1 describes the features of the Catalyst 4503-E switch chassis.

Table 1-1 Catalyst 4503-E Switch Features

Feature	Description
Chassis	Three horizontal slots. Slots are numbered from 1 (top) to 3 (bottom).
Supervisor engines	<ul style="list-style-type: none"> • Supports the following supervisor engines: <ul style="list-style-type: none"> – Supervisor Engine 9-E – Supervisor Engine 8L-E – Supervisor Engine 8-E – Supervisor Engine 7L-E – Supervisor Engine 7-E <p>Note Refer to your software release notes for the minimum software release versions required to support the supervisor engines.</p> <ul style="list-style-type: none"> • Supervisor engines must be installed in slot 1. • Supervisor engine redundancy is not supported in this chassis. <p>Note Check your software release notes for any restrictions on the type of module that can be installed.</p>
Modules	<ul style="list-style-type: none"> • Supports up to two Catalyst 4500 series modules. • Some Catalyst 4500 series modules may: <ul style="list-style-type: none"> – Not be supported – Require that you install a specific supervisor engine model – Have chassis slot restrictions – Require a specific software release level to operate <p>Note Check your software release notes for specific support information.</p>
Backplane	48 Gbps full duplex per slot (96 Gbps)
Fan tray	<ul style="list-style-type: none"> • The chassis supports one hot-swappable fan tray. One fan tray model is available: <ul style="list-style-type: none"> – WS-X4593-E • The fan tray contains six individual fans. The individual fans are not field replaceable; you must replace the fan tray in the event of a fan failure. • Air is drawn in on the right side of the chassis and exhausted on the left side of the chassis. • Fan tray STATUS LED (located on the fan tray front panel) <ul style="list-style-type: none"> – Red—One or more individual fans have failed. – Green—Fan tray is operating normally.

Table 1-1 Catalyst 4503-E Switch Features (continued)

Feature	Description
Power supply	<ul style="list-style-type: none"> • Supports one or two power supplies. The following power supplies are supported: <ul style="list-style-type: none"> – 1000 W AC-input power supply (PWR-C45-1000AC) – 1400 W AC-input power supply (PWR-C45-1400AC) – 1300 W AC-input power supply (PWR-C45-1300ACV) – 2800 W AC-input power supply (PWR-C45-2800ACV) – 4200 W AC-input power supply (PWR-C45-4200ACV) – 6000 W AC-input power supply (PWR-C45-6000ACV) – 9000 W AC-input power supply (PWR-C45-9000ACV) – 1400 W DC-input power supply, triple-input (PWR-C45-1400DC) – 1400 W DC-input power supply with integrated PEM (PWR-C45-1400DC-P) – External AC power shelf (WS-P4502-1PSU) • All Catalyst 4500 series AC-input power supplies require single-phase source AC. • Source AC can be out of phase between multiple power supplies or multiple AC-power plugs on the same power supply because all AC power supply inputs are isolated. • Single power supplies are installed in the left power supply bay. The second power supply is installed in the right power supply bay. <p>Note For proper operation of the power supply OUTPUT FAIL LED, systems with single power supplies must be configured with a minimum of one fan tray and one supervisor engine. Systems with dual power supplies must have a minimum configuration of one fan tray, one supervisor engine, and one additional module. Failure to meet these minimum configuration requirements can cause a false power supply output fail signal.</p>

Table 1-2 lists the environmental and physical specifications of the Catalyst 4503-E switch.

Table 1-2 Catalyst 4503-E Switch Specifications

Item	Specification
Temperature, ambient	<ul style="list-style-type: none"> Operating: 32° to 104°F (0° to 40°C) Nonoperating and storage: -40 to 167°F (-40 to 75°C)
Humidity (RH), ambient (noncondensing)	<ul style="list-style-type: none"> Operating: 10% to 90% Nonoperating and storage: 5% to 95%
Altitude, operating and nonoperating	-196 to 6561 ft (-60 to 2000 m)
Sound pressure level	<ul style="list-style-type: none"> One PS: 63.6 dBA at low speed and 62.3 dBA at full speed Two PS: 65 dBA at low speed and 65.4 dBA at full speed
Dimensions (H x W x D) and rack units (RU)	<ul style="list-style-type: none"> 12.25 x 17.31 x 12.50 in. (31.12 x 43.97 x 31.70 cm) 7 RU
Weight	<ul style="list-style-type: none"> 32.25 lbs (14.63 kg) minimum weight 75 lbs (34 kg) maximum weight
Airflow	<ul style="list-style-type: none"> Chassis fan tray: Right to left Power supply fan: Front to back

Catalyst 4506-E Switch

The Catalyst 4506-E switch is a 6-slot horizontal chassis supporting redundant power supplies, a single supervisor engine, and slots for up to five modules. [Figure 1-2](#) shows a front view of the Catalyst 4506-E switch with the chassis major features identified.

Figure 1-2 Catalyst 4506-E Switch (Front View)

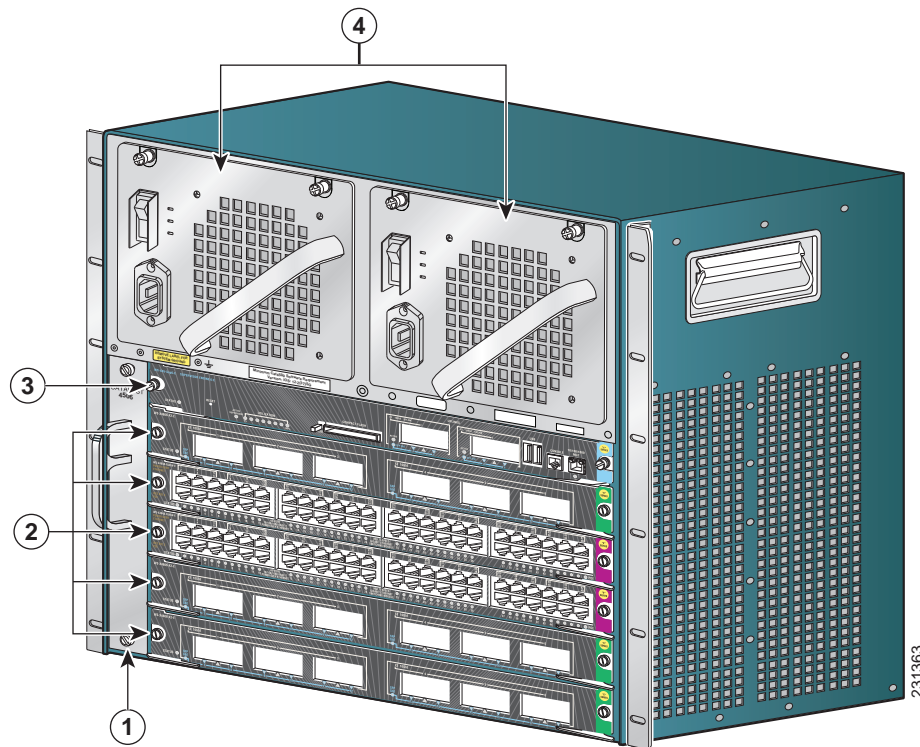

1	Fan tray assembly	3	Supervisor engine (slot 1)
2	Switching modules (slots 2 to 6)	4	Power supplies

Table 1-3 describes the features of the Catalyst 4506-E switch chassis.

Table 1-3 Catalyst 4506-E Switch Features

Feature	Description
Chassis	Six horizontal slots. Slots are numbered from 1 (top) to 6 (bottom).
Supervisor engines	<ul style="list-style-type: none"> • Supports the following supervisor engines: <ul style="list-style-type: none"> – Supervisor Engine 9-E – Supervisor Engine 8L-E – Supervisor Engine 8-E – Supervisor Engine 7L-E – Supervisor Engine 7-E <p>Note Refer to your software release notes for the minimum software release versions required to support the supervisor engines.</p> <ul style="list-style-type: none"> • Supervisor engines must be installed in slot 1. • Supervisor engine redundancy is not supported in this chassis.
Modules	<ul style="list-style-type: none"> • Supports up to five Catalyst 4500 series modules. • Some Catalyst 4500 series modules may: <ul style="list-style-type: none"> – Not be supported – Require that you install a specific supervisor engine – Have chassis slot restrictions – Require a specific software release level to operate • Check your software release notes for specific support information.
Backplane	48 Gbps full duplex per slot (240 Gbps)
Fan tray	<ul style="list-style-type: none"> • The chassis supports a single hot-swappable fan tray. One fan tray model is available: <ul style="list-style-type: none"> – WS-X4596-E • The fan tray contains four individual fans. The individual fans are not field replaceable; you must replace the fan tray in the event of a fan failure. • Air is drawn in on the right side of the chassis and exhausted on the left side of the chassis. • Fan tray STATUS LED (located on the fan tray front panel) <ul style="list-style-type: none"> – Red—One or more individual fans have failed. – Green—Fan tray is operating normally.

Table 1-3 Catalyst 4506-E Switch Features (continued)

Feature	Description
Power supply	<ul style="list-style-type: none"> • Supports one or two power supplies. The following power supplies are supported: <ul style="list-style-type: none"> – 1000 W AC-input power supply (PWR-C45-1000AC) – 1400 W AC-input power supply (PWR-C45-1400AC) – 1300 W AC-input power supply (PWR-C45-1300ACV) – 2800 W AC-input power supply (PWR-C45-2800ACV) – 4200 W AC-input power supply (PWR-C45-4200ACV) – 6000 W AC-input power supply (PWR-C45-6000ACV) – 9000 W AC-input power supply (PWR-C45-9000ACV) – 1400 W DC-input power supply, triple-input (PWR-C45-1400DC) – 1400 W DC-input power supply with integrated PEM (PWR-C45-1400DC-P) – External AC power shelf (WS-P4502-1PSU) • All Catalyst 4500 series AC-input power supplies require single-phase source AC. • Source AC can be out of phase between multiple power supplies or multiple AC-power plugs on the same power supply because all AC power supply inputs are isolated. • Single power supplies are installed in the left power supply bay. The second power supply is installed in the right power supply bay. <p>Note For proper operation of the power supply OUTPUT FAIL LED, systems with single power supplies must be configured with a minimum of one fan tray and one supervisor engine. Systems with dual power supplies must have a minimum configuration of one fan tray, one supervisor engine, and one additional module. Failure to meet these minimum configuration requirements can cause a false power supply output fail signal.</p>

Table 1-4 lists the environmental and physical specifications of the Catalyst 4506-E switch.

Table 1-4 Catalyst 4506-E Switch Specifications

Item	Specification
Temperature, ambient	<ul style="list-style-type: none"> Operating: 32° to 104°F (0° to 40°C) Nonoperating and storage: -40° to 167°F (-40° to 75°C)
Humidity (RH), ambient (noncondensing)	<ul style="list-style-type: none"> Operating: 10% to 90% Nonoperating and storage: 5% to 95%
Altitude, operating and nonoperating	-196 to 6561 ft (-60 to 2000 m)
Sound pressure level	<ul style="list-style-type: none"> One PS: 60.8 dBA at low speed and 62.1 dBA at full speed Two PS: 65 dBA at low speed and 65.6 dBA at full speed
Dimensions (H x W x D) and rack units (RU)	<ul style="list-style-type: none"> 17.38 x 17.31 x 12.50 in. (44.13 x 43.97 x 31.70 cm) 10 RU
Weight	<ul style="list-style-type: none"> 40.50 lbs (18.37 kg) minimum weight 100 lbs (45.4 kg) maximum weight
Airflow	<ul style="list-style-type: none"> Chassis fan tray: Right to left Power supply fan: Front to back <p>Note We recommend that you maintain a minimum air space of 6 inches (16 cm) between walls and the chassis air vents and a minimum horizontal separation of 12 inches (30.5 cm) between two chassis to prevent overheating.</p>

Catalyst 4507R-E Switch

The Catalyst 4507R-E switch is a 7-slot horizontal chassis supporting redundant power supplies, redundant supervisor engines, and slots for up to six modules. [Figure 1-3](#) shows a front view of the Catalyst 4507R-E switch with the chassis major features identified.

Figure 1-3 Catalyst 4507R-E Switch (Front View)

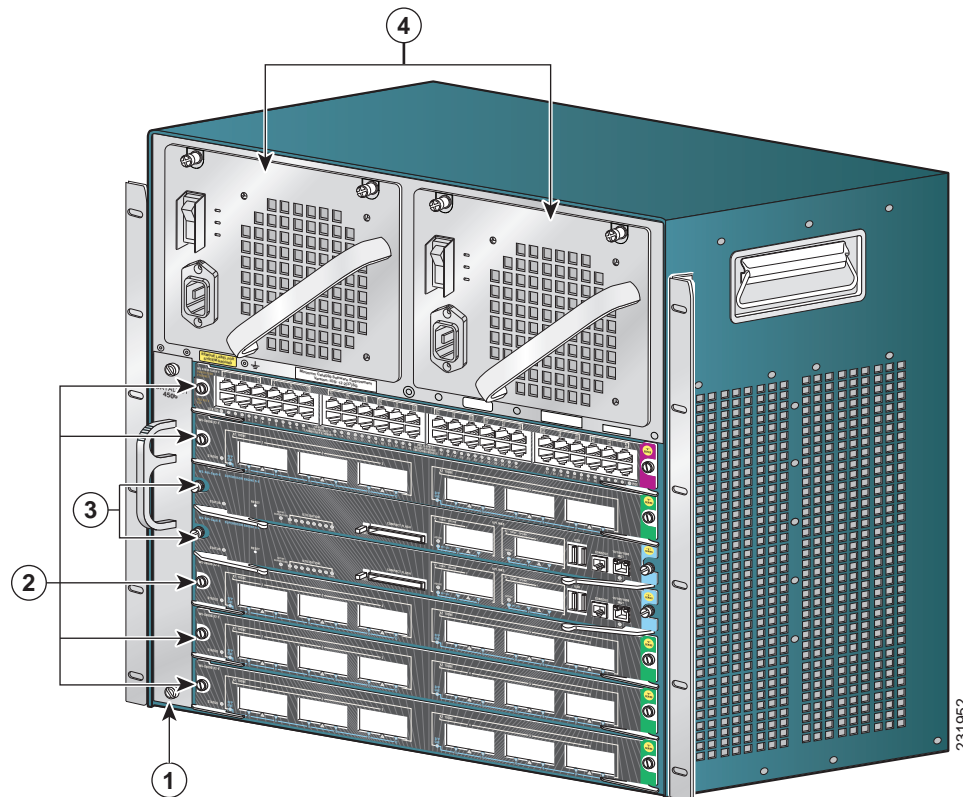

1	Fan tray	3	Supervisor engines (primary in slot 3 and secondary in slot 4)
2	Switching modules (slots 1, 2, 5, 6, 7)	4	Power supplies

[Table 1-5](#) describes the features of the Catalyst 4507R-E switch.

Table 1-5 Catalyst 4507R-E Switch Features

Feature	Description
Chassis	Seven horizontal slots. Slots are numbered from 1 (top) to 7 (bottom).
Supervisor engines	<ul style="list-style-type: none"> Supports the following supervisor engines: <ul style="list-style-type: none"> Supervisor Engine 8L-E¹ Supervisor Engine 8-E¹ Supervisor Engine 7L-E Supervisor Engine 7-E <p>Note Refer to your software release notes for the minimum software release versions required to support the supervisor engines.</p> <ul style="list-style-type: none"> Supervisor engines must be installed in slot 3 and in slot 4. Supervisor engine redundancy is supported in this chassis. <p>Note The Catalyst 4507R-E switch supports 1+1 supervisor-engine redundancy for integrated resiliency. Redundant supervisor engines help minimize network downtime. With the support of stateful switchover (SSO), the secondary supervisor engine serves as a backup to immediately take over after a primary supervisor failure. During the switchover, Layer 2 links are maintained transparently without the need to renegotiate sessions.</p>
Modules	<ul style="list-style-type: none"> Supports up to five Catalyst 4500 series modules. Some Catalyst 4500 series modules may: <ul style="list-style-type: none"> Not be supported Require that you install a specific supervisor engine Have chassis slot restrictions Require a specific software release level to operate Check your software release notes for specific support information.
Backplane	24 Gbps full duplex per slot (240 Gbps).
Fan tray	<ul style="list-style-type: none"> The chassis supports a single hot-swappable fan tray. One fan tray model is available: <ul style="list-style-type: none"> WS-X4597-E <p>Note The Catalyst 4507R-E switch and the Catalyst 4507R+E switch use the same fan tray.</p> <ul style="list-style-type: none"> The fan tray contains eight individual fans. The individual fans are not field replaceable; you must replace the fan tray in the event of a fan failure. Air is drawn in on the right side of the chassis and exhausted on the left side of the chassis. Fan tray STATUS LED (located on the fan tray front panel) <ul style="list-style-type: none"> Red—One or more individual fans have failed. Green—Fan tray is operating normally.

Table 1-5 Catalyst 4507R-E Switch Features (continued)

Feature	Description
Power supply	<ul style="list-style-type: none"> • Supports one or two power supplies. The following power supplies are supported: <ul style="list-style-type: none"> – 1000 W AC-input power supply (PWR-C45-1000AC) – 1400 W AC-input power supply (PWR-C45-1400AC) – 1300 W AC-input power supply (PWR-C45-1300ACV) – 2800 W AC-input power supply (PWR-C45-2800ACV) – 4200 W AC-input power supply (PWR-C45-4200ACV) – 6000 W AC-input power supply (PWR-C45-6000ACV) – 9000 W AC-input power supply (PWR-C45-9000ACV) – 1400 W DC-input power supply, triple-input (PWR-C45-1400DC) – 1400 W DC-input power supply with integrated PEM (PWR-C45-1400DC-P) – External AC power shelf (WS-P4502-1PSU) • All Catalyst 4500 series AC-input power supplies require single-phase source AC. • Source AC can be out of phase between multiple power supplies or multiple AC-power plugs on the same power supply because all AC power supply inputs are isolated. • Single power supplies are installed in the left power supply bay. The second power supply is installed in the right power supply bay. <p>Note For proper operation of the power supply OUTPUT FAIL LED, systems with single power supplies must be configured with a minimum of one fan tray and one supervisor engine. Systems with dual power supplies must have a minimum configuration of one fan tray, one supervisor engine, and one additional module. Failure to meet these minimum configuration requirements can cause a false power supply output fail signal.</p>

1. To support Supervisor Engine 8-E and 8L-E, the Cisco Catalyst 4507R-E Switch chassis must have hardware revision 2.0 or higher. Note that the hardware revision is with reference to the chassis and not the supervisor engine.

Table 1-6 lists the environmental and physical specifications of the Catalyst 4507R-E switch.

Table 1-6 Catalyst 4507R-E Switch Specifications

Item	Specification
Temperature, ambient	<ul style="list-style-type: none"> • Operating: 32° to 104°F (0° to 40°C) • Nonoperating and storage: –40° to 167°F (–40° to 75°C)
Humidity (RH), ambient (noncondensing)	<ul style="list-style-type: none"> • Operating: 10% to 90% • Nonoperating and storage: 5% to 95%
Altitude, operating and nonoperating	–196 to 6561 ft (–60 to 2000 m)

Table 1-6 Catalyst 4507R-E Switch Specifications (continued)

Item	Specification
Sound pressure level	<ul style="list-style-type: none"> • One PS: 63.6 dBA at low speed and 68.3 dBA at full speed • Two PS: 65.4 dBA at low speed and 68.4 dBA at full speed
Dimensions (H x W x D) and rack units (RU)	<ul style="list-style-type: none"> • 19.19 x 17.31 x 12.50 in. (48.74 x 43.97 x 31.70 cm) • 11 RU
Weight	<ul style="list-style-type: none"> • 44.5 lbs (20.19 kg) minimum weight • 100 lbs (45.4 kg) maximum weight
Airflow	<p>Chassis fan tray: Right to left</p> <p>Power supply fan: Front to back</p> <p>Note We recommend that you maintain a minimum air space of 6 inches (16 cm) between walls and the chassis air vents and a minimum horizontal separation of 12 inches (30.5 cm) between two chassis to prevent overheating.</p>

Catalyst 4510R-E Switch

The Catalyst 4510R-E switch is a 10-slot horizontal chassis supporting redundant power supplies, redundant supervisor engines, and slots for up to nine modules. [Figure 1-4](#) shows a front view of the Catalyst 4510R-E switch with the chassis major features identified.

Figure 1-4 Catalyst 4510R-E Switch Chassis (Front View)

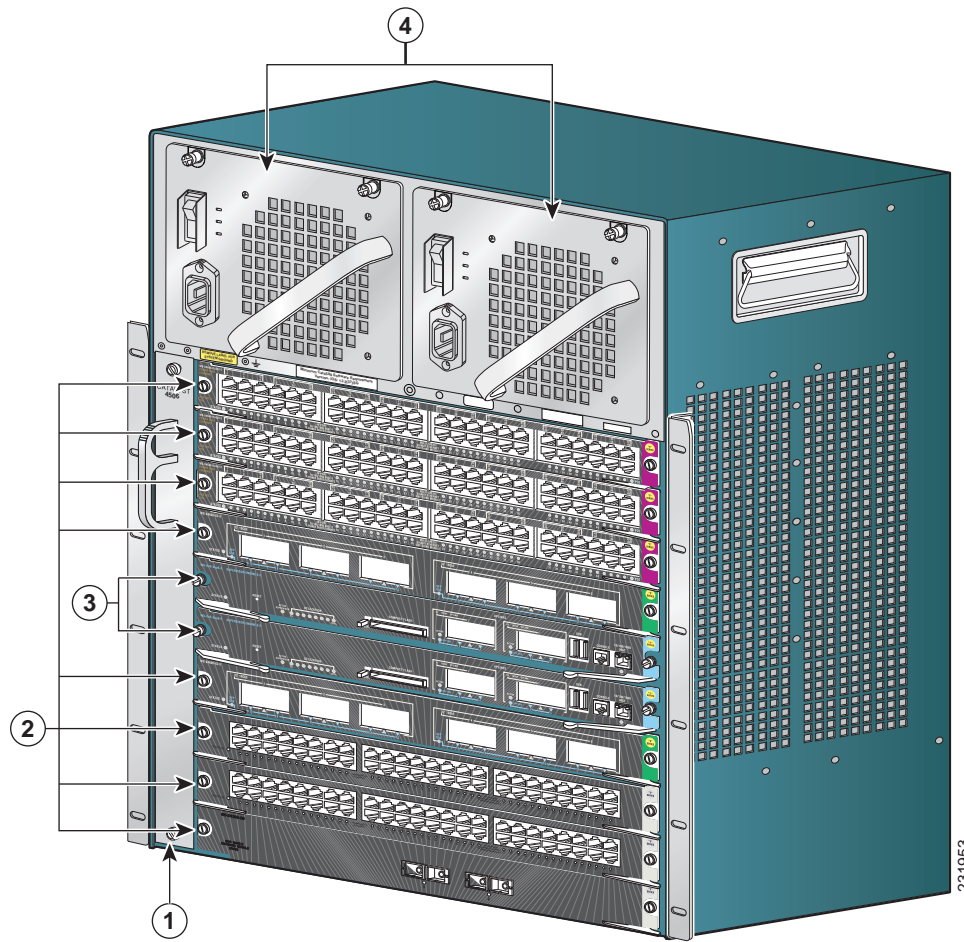

1	Fan tray assembly	3	Supervisor engines (primary in slot 5 and secondary in slot 6)
2	Switching modules (slots 1–4 and 7–10)	4	Power supplies

[Table 1-7](#) describes the features of the Catalyst 4510R-E switch.

Table 1-7 Catalyst 4510R-E Switch Features

Feature	Description
Chassis	Ten horizontal slots. Slots are numbered from 1 (top) to 10 (bottom).
Supervisor engines	<ul style="list-style-type: none"> • Supports the following supervisor engines: <ul style="list-style-type: none"> – Supervisor Engine 8-E – Supervisor Engine 7-E <p>Note Refer to your software release notes for the minimum software release versions required to support the supervisor engines.</p> <ul style="list-style-type: none"> • Supervisor engines must be installed in slot 5 or in slot 6. • Supervisor engine redundancy is supported in this chassis. <p>Note The Catalyst 4510R-E switch supports 1+1 supervisor-engine redundancy for integrated resiliency. With the support of stateful switchover (SSO), the secondary supervisor engine serves as a backup to immediately take over after a primary supervisor failure. During the switchover, Layer 2 links are maintained transparently without the need to renegotiate sessions.</p>
Modules	<ul style="list-style-type: none"> • Supports up to eight Catalyst 4500 series modules. • Some Catalyst 4500 series modules may: <ul style="list-style-type: none"> – Not be supported – Require that you install a specific supervisor engine – Have chassis slot restrictions – Require a specific software release level to operate • Check your software release notes for specific support information.
Backplane	24 Gbps full duplex per slot on five slots, plus 12 Gbps full duplex per slot on three slots (276 Gbps) with Supervisor Engine 6-E
Fan tray	<ul style="list-style-type: none"> • The chassis supports one hot-swappable fan tray. One fan tray model is available: <ul style="list-style-type: none"> – WS-X4582-E (located on the fan tray front panel) <p>Note The Catalyst 4510R-E and the Catalyst 4510R+E switches use the same fan tray.</p> <ul style="list-style-type: none"> • The fan tray contains ten individual fans. The individual fans are not field replaceable; you must replace the fan tray in the event of a fan failure. • Air is drawn in on the right side of the chassis and exhausted on the left side of the chassis. • Fan tray STATUS LED (located on the fan tray front panel) <ul style="list-style-type: none"> – Red—One or more individual fans have failed. – Green—Fan tray is operating normally.

Table 1-7 Catalyst 4510R-E Switch Features (continued)

Feature	Description
Power supply	<ul style="list-style-type: none"> • Supports one or two power supplies. The following power supplies are supported: <ul style="list-style-type: none"> – 1000 W AC-input power supply (PWR-C45-1000AC) – 1400 W AC-input power supply (PWR-C45-1400AC) – 1300 W AC-input power supply (PWR-C45-1300ACV) – 2800 W AC-input power supply (PWR-C45-2800ACV) – 4200 W AC-input power supply (PWR-C45-4200ACV) – 6000 W AC-input power supply (PWR-C45-6000ACV) – 9000 W AC-input power supply (PWR-C45-9000ACV) – 1400 W DC-input power supply, triple-input (PWR-C45-1400DC) – 1400 W DC-input power supply with integrated PEM (PWR-C45-1400DC-P) – External AC power shelf (WS-P4502-1PSU) • All Catalyst 4500 series AC-input power supplies require single-phase source AC. • Source AC can be out of phase between multiple power supplies or multiple AC-power plugs on the same power supply because all AC power supply inputs are isolated. • Single power supplies are installed in the left power supply bay. The second power supply is installed in the right power supply bay. <p>Note For proper operation of the power supply OUTPUT FAIL LED, systems with single power supplies must be configured with a minimum of one fan tray and one supervisor engine. Systems with dual power supplies must have a minimum configuration of one fan tray, one supervisor engine, and one additional module. Failure to meet these minimum configuration requirements can cause a false power supply output fail signal.</p>

Table 1-8 lists the environmental and physical specifications of the Catalyst 4510R-E switch.

Table 1-8 Catalyst 4510R-E Switch Specifications

Item	Specification
Temperature, ambient	<ul style="list-style-type: none"> Operating: 32° to 104°F (0° to 40°C) Nonoperating and storage: -40° to 167°F (-40° to 75°C)
Humidity (RH), ambient (noncondensing)	<ul style="list-style-type: none"> Operating: 10% to 90% Nonoperating and storage: 5% to 95%
Altitude, operating	-196 to 6561 ft (-60 to 2000 m)
Sound pressure level	<ul style="list-style-type: none"> One PS—63.6 dBA at low speed and 68.3 dBA at full speed Two PS—65.4 dBA at low speed and 68.4 dBA at full speed
Dimensions (H x W x D) and rack units (RU)	<ul style="list-style-type: none"> 24.35 x 17.31 x 12.50 in. (61.84 x 43.97 x 31.70 cm) 14 RU
Weight	<ul style="list-style-type: none"> 54.5 lbs (24.77 kg) minimum 108 lbs (45.4 kg) maximum
Airflow	<ul style="list-style-type: none"> Chassis fan tray: Right to left Power supply fan: Front to back <p>Note We recommend that you maintain a minimum air space of 6 inches (16 cm) between walls and the chassis air vents and a minimum horizontal separation of 12 inches (30.5 cm) between two chassis to prevent overheating.</p>

Catalyst 4507R+E Switch

The Catalyst 4507R+E switch is a 7-slot horizontal chassis supporting redundant power supplies, redundant supervisor engines, and slots for up to five modules. [Figure 1-5](#) shows a front view of the Catalyst 4507R+E switch with the chassis major features identified.

Figure 1-5 Catalyst 4507R+E Switch Chassis

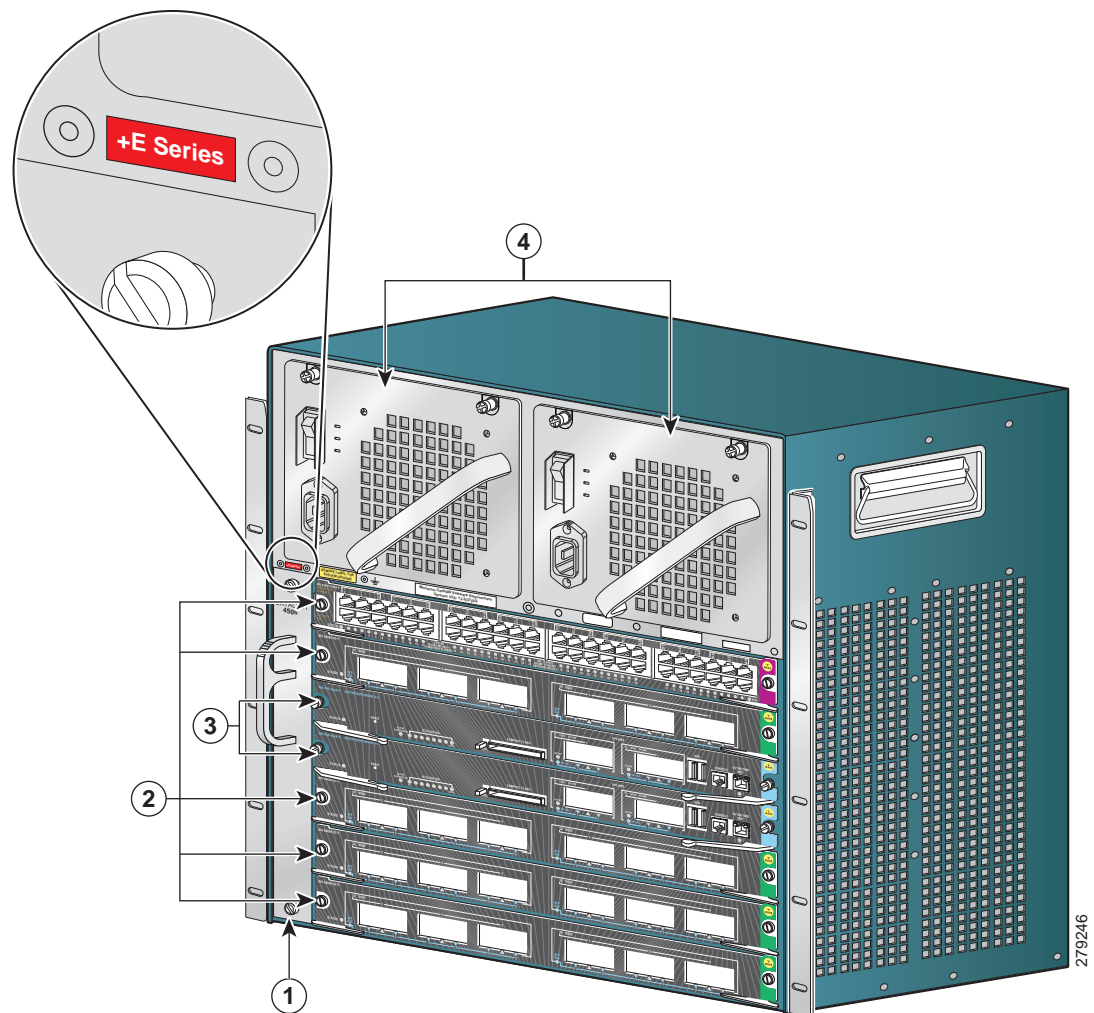

1	Fan tray	3	Supervisor engines (primary in slot 3 and secondary in slot 4)
2	Switching modules (slots 1, 2, 5, 6, 7)	4	Power supplies

[Table 1-9](#) describes the features of the Catalyst 4507R+E switch.

Table 1-9 Catalyst 4507R+E Switch Features

Feature	Description
Chassis	Seven horizontal slots. Slots are numbered from 1 (top) to 7 (bottom).
Supervisor engines	<ul style="list-style-type: none"> • Supports the following supervisor engines: <ul style="list-style-type: none"> – Supervisor Engine 9-E – Supervisor Engine 8L-E – Supervisor Engine 8-E – Supervisor Engine 7L-E – Supervisor Engine 7-E <p>Note Refer to your software release notes for the minimum software release versions required to support the supervisor engines.</p> <ul style="list-style-type: none"> • Supervisor engines must be installed in slot 3 or in slot 4. • Supervisor engine redundancy is supported in this chassis. <p>Note The Catalyst 4507R+E switch supports 1+1 supervisor-engine redundancy. With the support of stateful switchover (SSO), the secondary supervisor engine serves as a backup to immediately take over after a primary supervisor failure. During the switchover, Layer 2 links are maintained transparently without the need to renegotiate sessions.</p>
Modules	<ul style="list-style-type: none"> • Supports up to five Catalyst 4500 series modules. • Some Catalyst 4500 series modules may: <ul style="list-style-type: none"> – Not be supported – Require that you install a specific supervisor engine – Have chassis slot restrictions – Require a specific software release level to operate • Check your software release notes for specific support information.
Backplane	48 Gbps full duplex per slot
Fan tray	<ul style="list-style-type: none"> • The chassis supports a single hot-swappable fan tray. One fan tray model is available: <ul style="list-style-type: none"> – WS-X4597+E • The fan tray contains eight individual fans. The individual fans are not field replaceable; you must replace the fan tray in the event of a fan failure. • Air is drawn in on the right side of the chassis and exhausted on the left side of the chassis. • Fan tray STATUS LED (located on the fan tray front panel) <ul style="list-style-type: none"> – Red—One or more individual fans have failed. – Green—Fan tray is operating normally.

Table 1-9 Catalyst 4507R+E Switch Features (continued)

Feature	Description
Power supply	<ul style="list-style-type: none"> • Supports one or two power supplies. The following power supplies are supported: <ul style="list-style-type: none"> – 1000 W AC-input power supply (PWR-C45-1000AC) – 1400 W AC-input power supply (PWR-C45-1400AC) – 1300 W AC-input power supply (PWR-C45-1300ACV) – 2800 W AC-input power supply (PWR-C45-2800ACV) – 4200 W AC-input power supply (PWR-C45-4200ACV) – 6000 W AC-input power supply (PWR-C45-6000ACV) – 9000 W AC-input power supply (PWR-C45-9000ACV) – 1400 W DC-input power supply, triple-input (PWR-C45-1400DC) – 1400 W DC-input power supply with integrated PEM (PWR-C45-1400DC-P) – External AC power shelf (WS-P4502-1PSU) • All Catalyst 4500 series AC-input power supplies require single-phase source AC. • Source AC can be out of phase between multiple power supplies or multiple AC-power plugs on the same power supply because all AC power supply inputs are isolated. • Single power supplies are installed in the left power supply bay. The second power supply is installed in the right power supply bay. <p>Note For proper operation of the power supply OUTPUT FAIL LED, systems with single power supplies must be configured with a minimum of one fan tray and one supervisor engine. Systems with dual power supplies must have a minimum configuration of one fan tray, one supervisor engine, and one additional module. Failure to meet these minimum configuration requirements can cause a false power supply output fail signal.</p>

Table 1-10 lists the environmental and physical specifications of the Catalyst 4507R+E switch.

Table 1-10 Catalyst 4507R+E Switch Specifications

Item	Specification
Temperature, ambient	<ul style="list-style-type: none"> Operating: 32° to 104°F (0° to 40°C) Nonoperating and storage: -40° to 167°F (-40° to 75°C)
Humidity (RH), ambient (noncondensing)	<ul style="list-style-type: none"> Operating: 10% to 90% Nonoperating and storage: 5% to 95%
Altitude, operating and nonoperating	-196 to 6561 ft (-60 to 2000 m)
Sound pressure level	<ul style="list-style-type: none"> One PS: 63.6 dBA at low speed and 68.3 dBA at full speed Two PS: 65.4 dBA at low speed and 68.4 dBA at full speed
Dimensions (H x W x D) and rack units (RU)	<ul style="list-style-type: none"> 19.19 x 17.31 x 12.50 in. (48.74 x 43.97 x 31.70 cm) 11 RU
Weight	<ul style="list-style-type: none"> 44.50 lb (20.19 kg)
Airflow	<ul style="list-style-type: none"> Chassis fan tray: Right to left Power supply fan: Front to back <p>Note We recommend that you maintain a minimum air space of 6 inches (16 cm) between walls and the chassis air vents and a minimum horizontal separation of 12 inches (30.5 cm) between two chassis to prevent overheating.</p>

Catalyst 4510R+E Switch

The Catalyst 4510R+E switch is a 10-slot horizontal chassis supporting redundant power supplies, redundant supervisor engines, and slots for up to nine modules. [Figure 1-6](#) shows a front view of the Catalyst 4510R+E switch with the chassis major features identified.

Figure 1-6 Catalyst 4510R+E Switch Chassis (Front View)

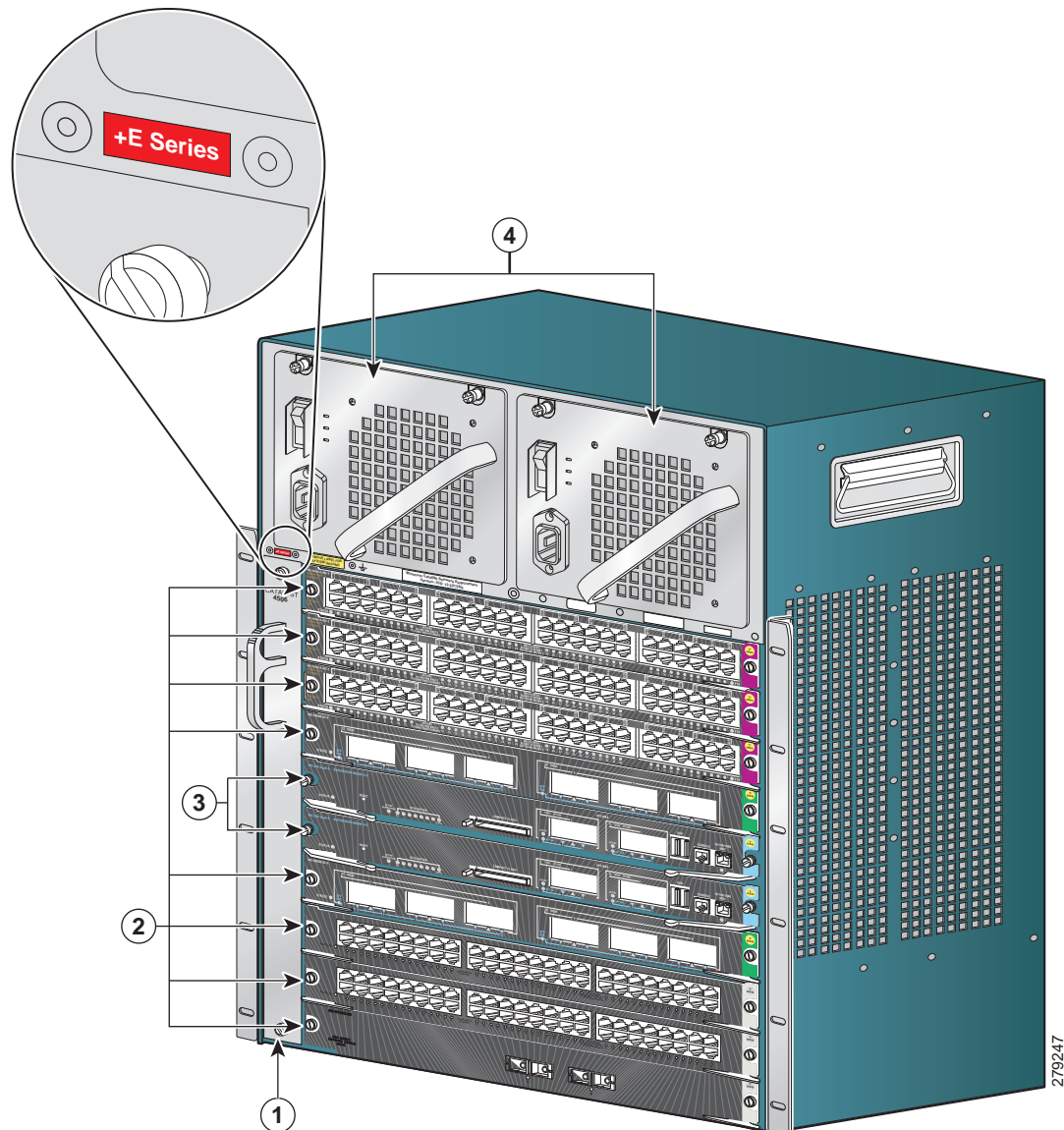

1	Fan tray	3	Supervisor engines (primary in slot 5 and secondary in slot 6)
2	Switching modules (slots 1–4, 7–10)	4	Power supplies

Table 1-11 describes the features of the Catalyst 4510R+E switch.

Table 1-11 Catalyst 4510R+E Switch Features

Feature	Description
Chassis	Ten horizontal slots. Slots are numbered from 1 (top) to 10 (bottom).
Supervisor engines	<ul style="list-style-type: none"> • Supports the following supervisor engines: <ul style="list-style-type: none"> – Supervisor Engine 9-E – Supervisor Engine 8-E – Supervisor Engine 7-E <p>Note Refer to your software release notes for the minimum software release versions required to support the supervisor engines.</p> <ul style="list-style-type: none"> • Supervisor engines must be installed in slot 5 or in slot 6. • Supervisor engine redundancy is supported in this chassis. <p>Note The Catalyst 4510R+E switch supports 1+1 supervisor engine redundancy for integrated resiliency. With the support of stateful switchover (SSO), the secondary supervisor engine serves as a backup to immediately take over after a primary supervisor failure. During the switchover, Layer 2 links are maintained transparently without the need to renegotiate sessions.</p>
Modules	<ul style="list-style-type: none"> • Supports up to eight Catalyst 4500 series modules. • Some Catalyst 4500 series modules may: <ul style="list-style-type: none"> – Not be supported – Require that you install a specific supervisor engine – Have chassis slot restrictions – Require a specific software release level to operate • Check your software release notes for specific information.
Backplane	48 Gbps full duplex per slot
Fan tray	<ul style="list-style-type: none"> • The chassis supports a single hot-swappable fan tray. One fan tray model is available: <ul style="list-style-type: none"> – WS-X4582+E • The fan tray contains ten individual fans. The individual fans are not field replaceable; you must replace the fan tray in the event of a fan failure. • Air is drawn in on the right side of the chassis and exhausted on the left side of the chassis. • Fan tray STATUS LED (located on the fan tray front panel) <ul style="list-style-type: none"> – Red—One or more individual fans have failed. – Green—Fan tray is operating normally.

Table 1-11 Catalyst 4510R+E Switch Features (continued)

Feature	Description
Power supply	<ul style="list-style-type: none"> • Supports one or two power supplies. The following power supplies are supported: <ul style="list-style-type: none"> – 1000 W AC-input power supply (PWR-C45-1000AC) – 1400 W AC-input power supply (PWR-C45-1400AC) – 1300 W AC-input power supply (PWR-C45-1300ACV) – 2800 W AC-input power supply (PWR-C45-2800ACV) – 4200 W AC-input power supply (PWR-C45-4200ACV) – 6000 W AC-input power supply (PWR-C45-6000ACV) – 9000 W AC-input power supply (PWR-C45-9000ACV) – 1400 W DC-input power supply, triple-input (PWR-C45-1400DC) – 1400 W DC-input power supply with integrated PEM (PWR-C45-1400DC-P) – External AC power shelf (WS-P4502-1PSU) • All Catalyst 4500 series AC-input power supplies require single-phase source AC. • Source AC can be out of phase between multiple power supplies or multiple AC-power plugs on the same power supply because all AC power supply inputs are isolated. • Single power supplies are installed in the left power supply bay. The second power supply is installed in the right power supply bay. <p>Note For proper operation of the power supply OUTPUT FAIL LED, systems with single power supplies must be configured with a minimum of one fan tray and one supervisor engine. Systems with dual power supplies must have a minimum configuration of one fan tray, one supervisor engine, and one additional module. Failure to meet these minimum configuration requirements can cause a false power supply output fail signal.</p>

Table 1-12 lists the environmental and physical specifications of the Catalyst 4510R+E switch.

Table 1-12 Catalyst 4510R+E Switch Specifications

Item	Specification
Temperature, ambient	<ul style="list-style-type: none"> Operating: 32° to 104°F (0° to 40°C) Nonoperating and storage: -40° to 167°F (-40° to 75°C)
Humidity (RH), ambient (noncondensing)	<ul style="list-style-type: none"> Operating: 10% to 90% Nonoperating and storage: 5% to 95%
Altitude, operating and nonoperating	-196 to 6561 ft (-60 to 2000 m)
Sound pressure level	<ul style="list-style-type: none"> One PS: 63.6 dBA at low speed and 68.3 dBA at full speed Two PS: 65.4 dBA at low speed and 68.4 dBA at full speed
Dimensions (H x W x D) and rack units (RU)	<ul style="list-style-type: none"> 24.35 x 17.31 x 12.50 in. (61.84 x 43.97 x 31.70 cm) 14 RU
Weight	<ul style="list-style-type: none"> 54.50 lb (24.73 kg)
Airflow	<ul style="list-style-type: none"> Chassis fan tray: Right to left Power supply fan: Front to back <p>Note We recommend that you maintain a minimum air space of 6 inches (16 cm) between walls and the chassis air vents and a minimum horizontal separation of 12 inches (30.5 cm) between two chassis to prevent overheating.</p>



CHAPTER 2

Preparing for Installation

Revised: October 2015

Planning a proper location for the switch and the layout of your equipment rack or wiring closet is essential for successful system operation. You should install the switch in an enclosed, secure area, ensuring that only qualified personnel have access to the switch and control of the environment. Equipment placed too close together or inadequately ventilated can cause system overtemperature conditions. In addition, poor equipment placement can make chassis panels inaccessible and difficult to maintain.



Tip

For additional information about the Cisco Catalyst 4500 E-series switches (including configuration examples and troubleshooting information), see the documents listed on this page:

<http://www.cisco.com/en/US/products/hw/switches/ps4324/index.html>

This chapter describes how to prepare your site for switch installation and contains these sections:

- [Safety, page 2-1](#)
- [Site Requirements, page 2-2](#)
- [Power Requirements, page 2-12](#)
- [Cabling Requirements, page 2-14](#)
- [Site Preparation Checklist, page 2-14](#)

Safety

Safety warnings appear throughout this publication in procedures that may harm you if performed incorrectly. A warning symbol precedes each warning statement. The warnings listed below are general warnings that are applicable to the entire publication.



Warning

This unit is intended for installation in restricted access areas. A restricted access area can be accessed only through the use of a special tool, lock and key, or other means of security.
Statement 1017

**Warning**

Only trained and qualified personnel should be allowed to install, replace, or service this equipment. Statement 1030

**Warning**

This equipment must be grounded. Never defeat the ground conductor or operate the equipment in the absence of a suitably installed ground conductor. Contact the appropriate electrical inspection authority or an electrician if you are uncertain that suitable grounding is available. Statement 1024

**Warning**

Class 1 laser product. Statement 1008

If you are using your switch as a source for Power over Ethernet (PoE), the following warning applies:

**Warning**

Voltages that present a shock hazard can exist on inline power circuits if interconnections are made by using uninsulated exposed metal contacts, conductors, or terminals. Avoid using such interconnection methods unless the exposed metal parts are in a restricted access location and users and service people who are authorized to access the location are made aware of the hazard. A restricted access area can be accessed only through the use of a special tool, lock and key, or other means of security. Statement 1072

Site Requirements

These sections describe some of the basic site requirements that you should be aware of as you prepare to install your Catalyst 4500 E-series switch. Environmental factors can adversely affect the performance and longevity of your system. Planning a proper location for the switch and layout of your equipment rack or wiring closet is essential for successful system operation. You should install the switch in an enclosed, secure area, ensuring that only qualified personnel have access to the switch and control of the environment. Equipment that is placed too closely together or that is inadequately ventilated can cause system overtemperature conditions leading to premature component failures. In addition, poor equipment placement can make chassis panels inaccessible and difficult to maintain.

The switch requires a dry, clean, well-ventilated, and air-conditioned environment. To ensure normal operation, maintain ambient airflow. If the airflow is blocked or restricted, or if the intake air is too warm, an overtemperature condition can occur. The switch environmental monitor can then shut down the system to protect the system components.

Multiple switches can be rack-mounted with little or no clearance above and below the chassis. However, when mounting a switch in a rack with other equipment, or when placing it on the floor near other equipment, ensure that the exhaust from other equipment does not blow into the air intake vent of the switch chassis.

Temperature

Temperature extremes can cause a system to operate at reduced efficiency and cause a variety of problems, including premature aging and failure of chips, and failure of mechanical devices. Extreme temperature fluctuations can cause chips to become loose in their sockets. Observe the following guidelines:

- Ensure that the system is operating in an environment no colder than 50°F (10°C) or hotter than 95°F (35°C).
- Ensure that the chassis has adequate ventilation.
- Do not place the chassis within a closed-in wall unit or on top of cloth, which can act as insulation.
- Do not place it where it will receive direct sunlight, particularly in the afternoon.
- Do not place it next to a heat source of any kind, including heating vents.
- Adequate ventilation is particularly important at high altitudes. Make sure that all slots and openings on the system remain unobstructed, especially the fan vent on the chassis.
- Clean the installation site at regular intervals to avoid buildup of dust and debris, which can cause a system to overheat.
- If the system has been exposed to abnormally cold temperatures, allow a 2-hour warm-up period to bring it up to normal operating temperature before turning it on.

Failure to observe these guidelines can damage internal components.

**Note**

The Catalyst 4500 E-series switches are equipped with internal air temperature sensors that are triggered at 104°F (40°C) generating a minor alarm and at 131°F (55°C) generating a major alarm.

Airflow

The Catalyst 4500 E-series switch is designed to be installed in an environment where there is a sufficient volume of air available to cool the supervisor engines, modules, and power supplies. Any constraints placed on the free flow of air through the chassis or an elevated ambient air temperature can cause the switch to overheat and shut down.

To maintain proper air circulation through the Catalyst 4500 E-series switch chassis, we recommend that you maintain a minimum 6-inch (15 cm) separation between a wall and the chassis air intake or a wall and the chassis hot air exhaust. In situations where the switch chassis are installed in adjacent racks, you should allow a minimum of 12-inches (30.5 cm) between the air intake of one chassis and the hot air exhaust of another chassis. Failure to maintain adequate spacing between chassis can cause the switch chassis that is drawing in the hot exhaust air to overheat and fail.

If you are installing your Catalyst 4500 E-series switch in an enclosed or partially enclosed rack, we strongly recommend that you verify that your site meets the following guidelines:

- Verify that there is a minimum of 6 inches (15 cm) of clearance between the sides of the rack and both the chassis air intake grill and the chassis air exhaust grill.
- Verify that the ambient air temperature within the enclosed or partially enclosed rack is within the chassis operating temperature limits. After installing the chassis in the rack, power up the chassis and allow the chassis temperature to stabilize (approximately 2 hours). Measure the ambient air temperature at the chassis air intake grill and at the chassis air exhaust grill by positioning an external temperature probe approximately 1 inch (2.5 cm) away from the grills, in line with the chassis slot occupied by the supervisor engine.
 - If the ambient intake air temperature is less than 104°F (40°C), the rack meets the intake air temperature criterion.
 - If the ambient intake air temperature exceeds 104°F (40°C), the system might experience minor temperature alarms and is in danger of overheating.
 - If the ambient intake air temperature equals or is greater than 131°F (55°C), the system will experience a major temperature alarm and shut down.
- Verify that the enclosed or partially enclosed rack allows an adequate flow of air through the switch chassis as follows:
 - If the difference between the measured intake air temperature and the exhaust air temperature does not exceed 10°C (18°F), there is sufficient airflow in the rack.
 - If the difference in air temperature exceeds 10°C (18°F), there is insufficient airflow to cool the chassis.



Note The 10°C (18°F) temperature differential between the intake and the exhaust must be determined by taking measurements using external digital temperature probes. Do not use the chassis internal temperature sensors to measure the temperature differential.

- Plan ahead. Your Catalyst 4500 E-series switches currently installed in an enclosed or partially enclosed rack might meet ambient air temperature and airflow requirements now. However, if you add more chassis to the rack or you add more modules to a chassis in the rack, the additional heat generated might cause the ambient air temperature within the rack to exceed 104°F (40°C) and can cause minor alarms.

Humidity

High-humidity conditions can cause moisture migration and penetration into the system. This moisture can cause corrosion of internal components and degradation of properties such as electrical resistance, thermal conductivity, physical strength, and size. Extreme moisture buildup inside the system can result in electrical shorts, which can cause serious damage to the system. Each system is rated to operate at 8 to 80 percent relative humidity, with a humidity gradation of 10 percent per hour. In storage, a system can withstand from 5 to 95 percent relative humidity. Buildings in which climate is controlled by air-conditioning in the warmer months and by heat during the colder months usually maintain an acceptable level of humidity for system equipment. However, if a system is located in an unusually humid location, a dehumidifier can be used to maintain the humidity within an acceptable range.

Altitude

Operating a system at high altitude (low pressure) reduces the efficiency of forced and convection cooling and can result in electrical problems related to arcing and corona effects. This condition can also cause sealed components with internal pressure, such as electrolytic capacitors, to fail or perform at reduced efficiency. Each system is rated to operate at altitudes from –50 to 6500 feet (–16 to 1981 meters) and can be stored at altitudes of –50 to 35,000 feet (–16 to 10,668 meters).

Dust and Particulates

Fans cool power supplies and system components by drawing in room temperature air and exhausting heated air out through various openings in the chassis. However, fans also ingest dust and other particles, causing contaminant buildup in the system and increased internal chassis temperature. A clean operating environment can greatly reduce the negative effects of dust and other particles, which act as insulators and interfere with the mechanical components in the system. The standards listed below provide guidelines for acceptable working environments and acceptable levels of suspended particulate matter:

- Network Equipment Building Systems (NEBS) GR-63-CORE
- National Electrical Manufacturers Association (NEMA) Type 1
- International Electrotechnical Commission (IEC) IP-20

Corrosion

Corrosion of system connectors is a gradual process that can eventually lead to intermittent failures of electrical circuits. The oil from a person's fingers or prolonged exposure to high temperature or humidity can corrode the gold-plated edge connectors and pin connectors on various components in the system. To prevent corrosion, avoid touching contacts on boards and cards, and protect the system from extreme temperatures and moist, salty environments.

Electromagnetic and Radio Frequency Interference

Electromagnetic interference (EMI) and radio frequency interference (RFI) from a system can adversely affect devices such as radio and television (TV) receivers operating near the system. Radio frequencies emanating from a system can also interfere with cordless and low-power telephones. Conversely, RFI from high-power telephones can cause spurious characters to appear on the system monitor. RFI is defined as any EMI with a frequency above 10 kilohertz (kHz). This type of interference can travel from the system to other devices through the power cable and power source or through the air like transmitted radio waves. The Federal Communications Commission (FCC) publishes specific regulations to limit the amount of EMI and RFI emitted by computing equipment. Each system meets these FCC regulations. To reduce the possibility of EMI and RFI, follow these guidelines:

- Only operate the system with the chassis covers installed.
- Ensure that all chassis slots are covered by a metal filler bracket and that an unused power supply bay has a metal cover plate installed.
- Ensure that the screws on all peripheral cable connectors are securely fastened to their corresponding connectors on the back of the chassis.
- Always use shielded cables with metal connector shells for attaching peripherals to the system.

When wires are run for any significant distance in an electromagnetic field, interference can occur between the field and the signals on the wires. This fact has two implications for the construction of plant wiring:

- Bad wiring practice can result in radio interference emanating from the plant wiring.
- Strong EMI, especially when it is caused by lightning or radio transmitters, can destroy the signal drivers and receivers in the chassis, and even create an electrical hazard by conducting power surges through lines into equipment.

**Note**

To predict and remedy strong EMI, you may also need to consult experts in radio frequency interference (RFI).

If you use twisted-pair cable in your plant wiring with a good distribution of grounding conductors, the plant wiring is unlikely to emit radio interference. If you exceed the recommended distances, use a high-quality twisted-pair cable with one ground conductor for each data signal when applicable.

**Caution**

Category 5e, Category 6, and Category 6a cables can store large levels of static electricity because of the dielectric properties of the materials used in their construction. Always ground the cables (especially in new cable runs) to a suitable and safe earth ground before connecting them to the module.

If the wires exceed the recommended distances, or if wires pass between buildings, give special consideration to the effect of a lightning strike in your vicinity. The electromagnetic pulse caused by lightning or other high-energy phenomena can easily couple enough energy into unshielded conductors to destroy electronic devices. If you have had problems of this sort in the past, you may want to consult experts in electrical surge suppression and shielding.

Shock and Vibration

Catalyst 4500 E-series switches have been shock- and vibration-tested for operating ranges, handling, and earthquake standards to NEBS (Zone 4 per GR-63-Core). These tests have been conducted in earthquake environment and criteria, office vibration and criteria, transportation vibration and criteria, and packaged equipment shock.

Power Source Interruptions

Systems are especially sensitive to variations in voltage supplied by the AC power source. Overvoltage, undervoltage, and transients (or spikes) can erase data from memory or even cause components to fail. To protect against these types of problems, power cables should always be properly grounded. Also, place the system on a dedicated power circuit (rather than sharing a circuit with other heavy electrical equipment). In general, do not allow the system to share a circuit with any of the following:

- Copy machines
- Air conditioners
- Vacuum cleaners

- Space heaters
- Power tools
- Teletype machines
- Laser printers
- Facsimile machines
- Any other motorized equipment

Besides these appliances, the greatest threats to a system power supply are surges or blackouts that are caused by electrical storms. Whenever possible, turn off the system and any peripherals, and unplug them from their power sources during thunderstorms. If a blackout occurs—even a temporary one—while the system is turned on, turn off the system immediately and disconnect it from the electrical outlet. Leaving the system on may cause problems when the power is restored; all other appliances left on in the area can create large voltage spikes that can damage the system.

System Grounding

You must install a NEBS-compliant system ground as part of the chassis installation process. Chassis installations that rely only on the AC third-prong ground are insufficient to properly and adequately ground the systems.

The system (NEBS) ground is different than the source power ground (AC third-prong ground on an AC power plug). The source power ground is designed for safety in the case of a short circuit in the power supply or a connection between the live voltage wire and the chassis. The resulting short circuit causes the source power circuit breaker to trip, which minimizes the damage to the chassis and the possible shock hazard to anyone in physical contact with the chassis. The source power ground usually does not have low impedance, it might be shared across many different types of devices, and it can have a floating voltage with reference to true earth ground.

The system (NEBS) ground should have the lowest possible impedance to true earth ground to ensure that there is no floating voltage. The system (NEBS) ground should have only communications equipment connected to it and should be free of induction or capacitance-induced voltages. In order to reduce the possibility of spurious signals and floating voltages from disrupting data transmissions, it might be necessary to install a new dedicated system (NEBS) ground in your data center.

You must observe the following system grounding guidelines for your chassis:

- You must install the system (NEBS) ground connection with any other rack or system power ground connections that you make. The system (NEBS) ground connection is required if FXS modules are installed or if this equipment is installed in a U.S. or European central office.
- You must connect both the system (NEBS) ground connection and the power supply ground connection to earth grounds.



Caution

Installations that rely solely on system grounding using only an AC third-prong ground run a substantially greater risk of equipment problems and data corruption than those installations that use both the AC third-prong ground and a properly installed system (NEBS compliant) ground.

Table 2-1 lists some general grounding practice guidelines.

Table 2-1 Grounding Practice Guidelines

Environment	Electromagnetic Noise Severity Level	Grounding Recommendation
Commercial building is subjected to direct lightning strikes. For example, some places in the United States, such as Florida, are subject to more lightning strikes than other areas.	High	All lightning protection devices must be installed in strict accordance with manufacturer recommendations. Conductors carrying lightning current should be spaced away from power and data lines in accordance with applicable recommendations and codes. Best grounding practices must be closely followed.
Commercial building is located in an area where lightning storms frequently occur but is not subject to direct lightning strikes.	High	Best grounding practices must be closely followed.
Commercial building contains a mix of information technology equipment and industrial equipment, such as welding.	Medium to High	Best grounding practices must be closely followed.
Existing commercial building is not subject to natural environmental noise or man-made industrial noise. This building contains a standard office environment. This installation has a history of malfunction due to electromagnetic noise.	Medium	Best grounding practices must be closely followed. Determine source and cause of noise if possible, and mitigate as closely as possible at the noise source or reduce coupling from the noise source to the victim equipment.
New commercial building is not subject to natural environmental noise or man-made industrial noise. This building contains a standard office environment.	Low	Best grounding practices should be followed as closely as possible. Electromagnetic noise problems are not anticipated, but installing a best practice grounding system in a new building is often the least expensive route and the best way to plan for the future.
Existing commercial building is not subject to natural environmental noise or man-made industrial noise. This building contains a standard office environment.	Low	Best grounding practices should be followed as much as possible. Electromagnetic noise problems are not anticipated, but installing a best practice grounding system is always recommended.

**Note**

In all situations, grounding practices must comply with Section 250 of the National Electric Code (NEC) requirements or local laws and regulations. A 6 AWG grounding wire is preferred from the chassis to the rack ground or directly to the common bonding network (CBN). The equipment rack should also be connected to the CBN with 6 AWG grounding wire.

**Note**

In installations where FXS modules are installed, supplemental grounding is required.

**Note**

Always ensure that all of the modules are completely installed and that the captive installation screws are fully tightened. In addition, ensure that all I/O cables and power cords are properly seated. These practices are normal installation practices and must be followed in all installations.

**Caution**

Category 5e, Category 6, and Category 6a cables can store large levels of static electricity because of the dielectric properties of the materials used in their construction. Always ground the cables (especially in new cable runs) to a suitable and safe earth ground before connecting them to the module.

Maintaining Safety with Electricity

When working on electrical equipment, follow these guidelines:

- Do not work alone if potentially hazardous conditions exist anywhere in your work space.
- Never assume that power is disconnected from a circuit; always check the circuit before working on it.
- Look carefully for possible hazards in your work area, such as damp floors, ungrounded power extension cables, frayed or damaged power cords, and missing safety grounds.
- If an electrical accident occurs, proceed as follows:
 - Use extreme caution; do not become a victim yourself.
 - Disconnect power from the system.
 - If possible, send another person to get medical aid. Otherwise assess the condition of the victim, and then call for help.
 - Determine if the person needs rescue breathing or external cardiac compressions; then take appropriate action.
- Use the product within its marked electrical ratings and product usage instructions.
- Install the product in compliance with local and national electrical codes.
- If any of the following conditions occur, contact the Cisco Technical Assistance Center:
 - The power cable or plug is damaged.
 - An object has fallen into the product.
 - The product has been exposed to water or other liquids.
 - The product has been dropped or shows signs of damage.
 - The product does not operate correctly when you follow the operating instructions.
- Use the correct external power source. Operate the product only from the type of power source indicated on the electrical ratings label. If you are not sure of the type of power source required, consult the Cisco Technical Assistance Center or a local electrician.

- Use approved power cables only. You have been provided with one or more power cables with your chassis power supply that are intended for use in your country, based on the shipping location. Should you need to purchase additional power cables, ensure that they are rated for the product and for the voltage and current marked on the product's electrical ratings label. The voltage and current rating of the power cable should be greater than the ratings marked on the label.
- To help prevent electrical shock, plug all power cables into properly grounded electrical outlets. These power cables are equipped with three-prong plugs to help ensure proper grounding. Do not use adapter plugs or remove the grounding prong from a power cable.
- Observe power strip ratings. Make sure that the total current rating of all products that are plugged into the power strip does not exceed 80 percent of the power strip rating.
- Do not modify power cables or plugs yourself. Consult with a licensed electrician or your power company for site modifications. Always follow your local and national wiring codes.

Preventing Electrostatic Discharge Damage

Electrostatic discharge (ESD) damage, which can occur when modules or other FRUs are improperly handled, results in intermittent or complete failures. Modules consist of printed circuit boards that are fixed in metal carriers. Electromagnetic interference (EMI) shielding and connectors are integral components of the carrier. Although the metal carrier helps to protect the board from ESD, always use an ESD grounding strap when handling modules.

To prevent ESD damage, follow these guidelines:

- Always use an ESD wrist strap and ensure that it makes maximum contact with bare skin. ESD grounding straps are available with banana plugs, metal spring clips, or alligator clips. All Catalyst 4500 E-series chassis are equipped with a bare metal hole banana plug connector (identified by the ground symbol next to the connector) somewhere on the front panel. We recommend that you use a personal ESD grounding strap equipped with a banana plug.
- If you choose to use the disposable ESD wrist strap supplied with most FRUs or an ESD wrist strap equipped with an alligator clip, you must attach the system ground lug to the chassis in order to provide a proper grounding point for the ESD wrist strap.



Note This system ground is also referred to as the network equipment building system (NEBS) ground.

- If your chassis does not have the system ground attached, you must install the system ground. See the [“Establishing the System Ground Connection” section on page 3-7](#) for installation instructions and locations of the chassis system ground pads.

After you install the system ground lug, follow these steps to correctly attach the ESD wrist strap:

-
- Step 1** Attach the ESD wrist strap to bare skin as follows:
- a. If you are using the ESD wrist strap supplied with the FRUs, open the wrist strap package and unwrap the ESD wrist strap. Place the black conductive loop over your wrist and tighten the strap so that it makes good contact with your bare skin.
 - b. If you are using an ESD wrist strap equipped with an alligator clip, open the package and remove the ESD wrist strap. Locate the end of the wrist strap that attaches to your body and secure it to your bare skin.
- Step 2** Grasp the spring or alligator clip on the ESD wrist strap and momentarily touch the clip to a bare metal spot (unpainted surface) on the rack. We recommend that you touch the clip to an unpainted rack rail so that any built-up static charge is then safely dissipated to the entire rack.
- Step 3** Attach either the spring clip or the alligator clip to the ground lug screw as follows:
- a. If you are using the ESD wrist strap that is supplied with the FRUs, squeeze the spring clip jaws open, position the spring clip to one side of the system ground lug screw head, and slide the spring clip over the lug screw head so that the spring clip jaws close behind the lug screw head.
-  **Note** The spring clip jaws do not open wide enough to fit directly over the head of the lug screw or the lug barrel.
-
- b. If you are using an ESD wrist strap that is equipped with an alligator clip, attach the alligator clip directly over the head of the system ground lug screw or to the system ground lug barrel.
-

When handling modules, follow these guidelines:

- Handle carriers by available handles or edges only; avoid touching the printed circuit boards or connectors.
- Place a removed component board-side-up on an antistatic surface or in a static shielding container. If you plan to return the component to the factory, immediately place it in a static shielding container.
- Never attempt to remove the printed circuit board from the metal carrier.

**Caution**

For safety, periodically check the resistance value of the antistatic strap. The measurement should be between 1 and 10 megohm (Mohm).

Power Requirements

When preparing your site for the switch installation, follow these requirements:

- In systems configured with two power supplies, connect each of the two power supplies to a separate input power source. If you fail to do this task, your system might be susceptible to total power failure due to a fault in the external wiring or a tripped circuit breaker.
- To prevent a loss of input power, be sure that the total maximum load on each source circuit is within the current ratings of the wiring and breakers.
- In some systems, you may decide to use an uninterruptible power supply (UPS) to protect against power failures at your site. Be aware when selecting a UPS that some UPS models that use ferroresonant technology can become unstable when operating with the Catalyst 4500 E-series switch power supplies which use power factor correction (PFC). Ferroresonant technology can cause the output voltage waveform to the switch to become distorted resulting in an undervoltage situation in the system.
- The AC-input power supply has a detachable power cord that allows you to connect each power supply to the site power source.
- You can connect the DC-input power supply to the power source with heavy-gauge wiring connected to a terminal block. The wire gauge size is determined by local electrical codes and restrictions.
- If you are using a 200/240 VAC power source in North America, the circuit must be protected by a two-pole circuit breaker.
- The source AC outlet must be within 6 feet (1.8 meters) of the system and should be easily accessible.
- The AC power receptacles used to plug in the chassis must be the grounding type. The grounding conductors that connect to the receptacles should connect to protective earth ground at the service equipment.

Power Connection Guidelines for AC-Powered Systems

This section provides the basic guidelines for connecting the Catalyst 4500 E-series switch AC power supplies to the site power source:

- Each chassis power supply should have a separate, dedicated branch circuit.
- For North America:
 - The 1000 W power supply requires a 15 A or 20 A circuit.
 - The 1300 W, 1400 W, and 2800 W power supplies require a 20 A circuit.
 - The 4200 W power supply requires one or two 15 A circuits.
 - The 6000 W power supply requires one or two 15 A circuits (low-line inputs) or one or two 20 A circuits (high-line inputs).
 - The 9000 W power supply requires up to three 15 A circuits (low-line inputs) or up to three 20 A circuits (high-line inputs).
- For International:
 - Circuits should be sized according to local and national codes.

- If you are using a 200/240 VAC power source in North America, the circuit must be protected by a two-pole circuit breaker.
- The source AC outlet must be within 6 feet (1.8 meters) of the system and should be easily accessible.
- The AC power receptacles used to plug in the chassis must be the grounding type. The grounding conductors that connect to the receptacles should connect to protective earth ground at the service equipment.

Power Connection Guidelines for DC-Powered Systems

This section provides the basic guidelines for connecting the Catalyst 4500 E-series switch DC-input power supplies to the site power source:

- All power connection wiring should conform to the rules and regulations in the National Electrical Code (NEC), as well as any local codes.
- DC (–) and the DC return (+) terminals are evaluated for use with 1/0 AWG wire (1400 W DC supply only).
- The ground terminal is evaluated for use with 6 AWG wire (10 AWG for the multi-input power supply).
- The DC return must remain isolated from the system frame and the chassis (DC-I).
- For DC power cables, we recommend that you use commensurately rated, high-strand-count copper wire cable. Connection to the DC-input power supply requires one earth ground cable, one source DC (–), and one source DC return (+). The length of the cables depends on your switch location. These cables are not available from Cisco Systems. They are available from any commercial cable vendor.
- The color coding of the source DC power cable leads depends on the color coding of the site DC power source. Typically, green or green and yellow indicate that the cable is a ground cable. Because there is no color code standard for source DC wiring, you must ensure that the power cables are connected to the DC-input power supply terminal block in the proper (+) and (–) polarity. In some cases, the source DC cable leads might have a positive (+) or a negative (–) label. This label is a relatively safe indication of the polarity, but you must verify the polarity by measuring the voltage between the DC cable leads. When making the measurement, the positive (+) lead and the negative (–) lead must always match the (+) and (–) labels on the DC-input power supply terminal block.
- DC power cables must be terminated by cable lugs at the power supply end.
- The circuit breaker is considered to be the disconnect device and should be easily accessible.
- The circuit must be protected by a dedicated two-pole circuit breaker. The circuit breaker should be sized according to the power supply input rating and local or national code requirements.
- For proper DC-input redundant power configurations on systems with multiple-input DC-input power supplies, all pairs of source DC cables for one DC-input power supply must come from the same battery system (A feed); all pairs of source DC cables for the second DC-input power supply must come from a different battery system (B feed).
- For DC-input power supplies with multiple inputs, each DC input must be protected by a dedicated circuit breaker or a fuse. The circuit breaker or the fuse must be sized according to the power supply input rating and local or national electrical codes.

Cabling Requirements

**Caution**

The intrabuilding port(s) of the equipment or subassembly is suitable for connection to intrabuilding or unexposed wiring or cabling only. The intrabuilding port(s) of the equipment or subassembly must not be metallically connected to interfaces that connect to the Outside Plant (OSP) or its wiring. These interfaces are designed for use as intrabuilding interfaces only (Type 2 or Type 4 ports as described in GR-1089-CORE, Issue 4) and require isolation from the exposed OSP cabling. The addition of Primary Protectors is not sufficient protection to connect these interfaces metallically to OSP wiring.

When running power and data cables together in overhead cable trays or subfloor cable trays, be aware of the following caution:

**Caution**

We strongly recommend that power cabling runs and other potential noise sources be located as far away as practical from LAN cabling that terminates on Cisco equipment. In situations, where this type of long parallel cable runs exist which cannot be separated by at least 3.3 feet (1 meter), we recommend that you shield these potential noise sources. To avoid interference, the source should be shielded by housing it in a grounded metallic conduit.

Also be aware of the following caution concerning the use of Category 5e and Category 6 Ethernet cables:

**Caution**

Category 5e, Category 6, and Category 6a cables can store large levels of static electricity because of the dielectric properties of the materials used in their construction. Always ground the cables (especially in new cable runs) to a suitable and safe earth ground before connecting them to the module.

Site Preparation Checklist

[Table 2-2](#) lists the site-planning activities that you should complete before you install a Catalyst 4500 E-series switch. Completing each activity helps to ensure a successful switch installation.

Table 2-2 Site-Planning Checklist

Task No.	Planning Activity	Verified by	Time	Date
1	Space evaluation: <ul style="list-style-type: none"> • Space and layout • Floor covering • Impact and vibration • Lighting • Maintenance access 			
2	Environmental evaluation: <ul style="list-style-type: none"> • Ambient temperature • Humidity • Altitude • Atmospheric contamination • Airflow 			
3	Power evaluation: <ul style="list-style-type: none"> • Input power type • Receptacle proximity to the equipment • Dedicated (separate) circuits for redundant power supplies • UPS for power failures 			
4	Grounding evaluation: <ul style="list-style-type: none"> • Circuit breaker size 			
5	Cable and interface equipment evaluation: <ul style="list-style-type: none"> • Cable type • Connector type • Cable distance limitations • Interface equipment (transceivers) 			
6	EMI evaluation: <ul style="list-style-type: none"> • Distance limitations for signaling • Site wiring • RFI levels 			



CHAPTER 3

Installing the Switch

Revised: October 2011

This chapter describes how to install Catalyst 4500 E-series switches in an equipment rack. The chapter contains the following sections:

- [Installation Process, page 3-2](#)
- [Rack-Mounting Guidelines, page 3-2](#)
- [Unpacking the Switch, page 3-4](#)
- [Installing the Switch in a Rack, page 3-4](#)
- [Establishing the System Ground Connection, page 3-7](#)
- [Completing the Installation Process, page 3-9](#)



Warning

This unit is intended for installation in restricted access areas. A restricted access area can be accessed only through the use of a special tool, lock and key, or other means of security. Statement 1017



Warning

Only trained and qualified personnel should be allowed to install, replace, or service this equipment. Statement 1030



Warning

To prevent personal injury or damage to the chassis, never attempt to lift or tilt the chassis using the handles on modules (such as power supplies, fans, or cards); these types of handles are not designed to support the weight of the unit. Statement 1032



Note

Before starting the installation procedures in this chapter, complete the site-planning checklist in [Table 2-2 of Chapter 2, “Preparing for Installation.”](#)



Note

For information on installing the supervisor engine and switching modules and verifying switch operation, see the *Catalyst 4500 Series Module Installation Guide*. For information on configuring the switching modules, see the software configuration guide for your switch and software release.

Installation Process

The process of installing the switch can be broken down into a series of tasks. These tasks are listed in [Table 3-1](#).

Table 3-1 Catalyst 4500 E-Series Switch Installation Process

Task	Description
Unpacking the switch	Remove the switch from the packaging materials. Note We recommend that you save the packaging material for use later if you need to move the chassis from one site to another.
Installing the switch	All Catalyst 4500 E-series chassis are designed to be rack-mounted.
Connecting the chassis to system ground	Construct and attach a system ground wire from the building (earth) ground to the system ground point on the chassis.
Installing and cabling the power supply or supplies	Normally, one power supply is shipped installed in the chassis. The second power supply, if part of the switch configuration, is shipped separately. Install the second power supply and connect the power supplies to site source power, either AC or DC.
Cabling the supervisor engine and modules to the network	The various ports on the supervisor engine and on the modules that are installed in the chassis must be connected to the network. This process can involve only attaching a network interface cable to the module port, or it can include the installation of a transceiver of some type in the supervisor engine or module port, and then attaching the network interface cable to the transceiver.
Powering up the chassis	After completing the network cabling and making sure that system ground is connected, the power supplies can be turned on. The system powers up and runs through a set of built-in diagnostics.



Tip

For additional information about the Cisco Catalyst 4500 E-series switches (including configuration examples and troubleshooting information), see the documents listed on this page:

<http://www.cisco.com/en/US/products/hw/switches/ps4324/index.html>

Rack-Mounting Guidelines

The Catalyst 4500 E-series switches are designed to be installed in both open and enclosed racks that meet ANSI/EIA-310-D and ETS 300 119-3 specifications. Before rack-mounting the switch, ensure that the equipment rack complies with the following guidelines:

- The width of the rack, measured between the two front-mounting strips or rails, must be 17.75 inches (45.09 cm).
- The depth of the rack, measured between the front- and rear-mounting strips, must be at least 19.25 inches (48.9 cm).



Note All of the Catalyst 4500 E-series switch chassis are designed to install in standard 19-inch racks.

- The rack must have sufficient vertical clearance to insert the chassis. The chassis heights are as follows:
 - Catalyst 4503-E switch—12.25 inches (31.12 cm) (7 RU)
 - Catalyst 4506-E switch—17.38 inches (44.13 cm) (10 RU)
 - Catalyst 4507R-E switch—19.15 inches (49 cm) (10 RU)
 - Catalyst 4510R-E switch—24.35 inches (61.84 cm) (14 RU)
 - Catalyst 4507R+E switch—19.15 inches (49 cm) (10 RU)
 - Catalyst 4510R+E switch—24.35 inches (61.84 cm) (14 RU)



Note Chassis height is sometimes measured in rack units (RU or just U) where 1 RU or 1 U equals 1.75 in (44.45 mm). A typical server rack is 42 RU or 42 U in height.



Caution If the equipment rack is on wheels, ensure that the brakes are engaged and that the rack is stabilized.



Warning **To prevent bodily injury when mounting or servicing this unit in a rack, you must take special precautions to ensure that the system remains stable. The following guidelines are provided to ensure your safety:**

- **This unit should be mounted at the bottom of the rack if it is the only unit in the rack.**
 - **When mounting this unit in a partially filled rack, load the rack from the bottom to the top with the heaviest component at the bottom of the rack.**
 - **If the rack is provided with stabilizing devices, install the stabilizers before mounting or servicing the unit in the rack. Statement 1006**
-



Note To maintain proper air circulation through the Catalyst switch chassis, we recommend that you maintain a minimum 6-inch (15 cm) separation between a wall and the chassis air intake or a wall and the chassis air exhaust. You should also allow a minimum separation of 12 inches (30.5 cm) between the hot air exhaust on one chassis and the air intake on another chassis. Failure to maintain adequate air space can cause the chassis to overheat and the system to fail.

Unpacking the Switch

To check the contents of the shipping cartons, follow these steps:

-
- Step 1** Check the contents of the accessories box against the accessories box components checklist and the packing slip that were included with your switch. Verify that you received all listed equipment, including the following:
- Rack-mount kit, cable guide kit, and system ground kit
 - Optional equipment that you ordered, such as network interface cables, transceivers, or special connectors
- Step 2** Check the switching modules in each slot. Verify that the configuration matches the packing list and that all the specified interfaces are included.
- Step 3** Verify that the L brackets are securely attached to the sides of the chassis.
-



Note Do not discard the shipping cartons and poly bag when you unpack the switch. Flatten and store them. You will need the containers if you need to move or ship the switch in the future. Repacking instructions are provided in [Appendix B, “Repacking a Switch.”](#)

Installing the Switch in a Rack

A rack-mount kit is included for mounting the switch in a standard 19-inch (48.3 cm) equipment rack with two unobstructed outer posts, with a nominal depth (between the front and rear mounting posts) of 19.25 inches (48.9 cm) and a maximum depth of 32 inches (81.3 cm). This kit is not suitable for racks with obstructions (such as a power strip) that could impair access to the field-replaceable units (FRUs) of the switch.

Determine if the rack post holes are prethreaded or unthreaded. If the rack post holes are unthreaded, you need to install 12-24 clip-nuts or cage-nuts over the rack post holes to accept the installation screws.



Note Clip-nuts or cage-nuts are not included as part of the accessory kit that comes with the chassis. You must obtain them yourself.

Required Installation Tools

You will need the following tools and equipment to install the chassis in a rack:

- Number 1 and number 2 Phillips-head screwdrivers to tighten the captive installation screws on most systems
- 3/16-inch flat-blade screwdriver for the captive installation screws on the supervisor engine and switching modules on some systems
- Antistatic mat or antistatic foam in case you need to remove switching modules to troubleshoot the installation
- Rack-mount kit

- Tape measure
- Level
- Your own electrostatic discharge (ESD) grounding strap or the disposable ESD strap included with the system

Installing the Catalyst 4500 E-Series Switches in a Rack

To install a Catalyst 4500 E-series switch in an equipment rack, follow these steps:

-
- Step 1** Place the chassis on the floor or on a sturdy table near the rack.
- Step 2** Use a tape measure to verify the interior dimensions of the rack:
- Measure the depth of the rack from the outside of the front mounting posts to the outside of the rear mounting strip. The depth must be at least 19.25 inches (48.9 cm) but not greater than 32 inches (81.3 cm).
 - Measure the space between the inner edges of the left front and right front mounting posts to ensure that it is 17.75 inches (45.09 cm) wide. (The chassis is 17.25 inches [43.8 cm] wide and must fit between the mounting posts.)
- Step 3** Carefully lift the chassis and position the rear of the chassis between the equipment rack mounting posts and slide the chassis into the rack until the L brackets on the sides of the chassis are flush with the equipment rack front posts. (See [Figure 3-1](#).)



Note [Figure 3-1](#) illustrate the installation of a Catalyst 4506-E switch. The other Catalyst 4500 E-series switches are installed in the equipment rack the same way.

- Step 4** Align the mounting holes in the L bracket with the mounting holes in the equipment rack posts. Use a tape measure and level to ensure that the chassis is positioned in the rack straight and level. If necessary, install at least six clip-nuts or cage-nuts (three per side) on the rack post to receive the installation screws.
- Step 5** Secure the chassis using at least six (three per side) 12-24 x 3/4-inch screws through the elongated holes in the L bracket and into the threaded holes in the mounting post (or the clip-nuts or cage-nuts).

Figure 3-1 Installing the Switch in the Rack (Catalyst 4506-E Switch Shown)

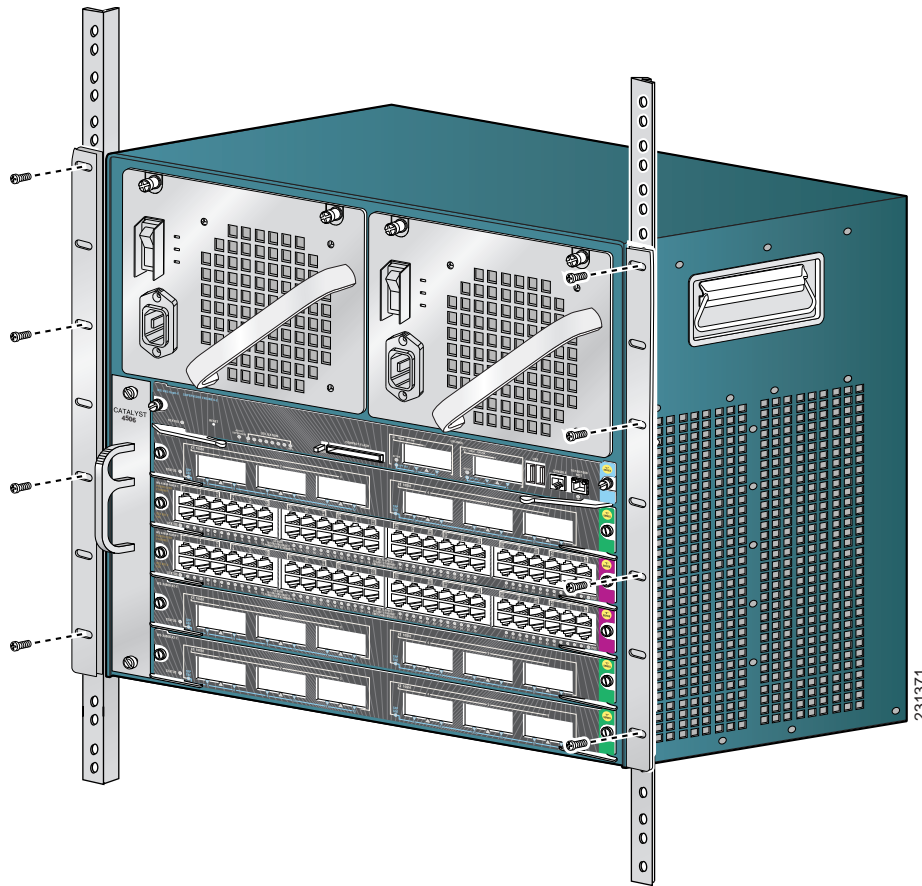

- a. Attach the cable guide, if needed, using the M3 screws provided in the cable management kit. The cable guide attaches to prethreaded holes in either L bracket. (See [Figure 3-2](#).)



Note

We recommend that you attach the cable guide to the right side of the switch chassis to prevent the network interface cables from obscuring switching module front panel LEDs.

Figure 3-2 Attaching the Cable Guide to the Chassis (Catalyst 4506-E Switch Shown)

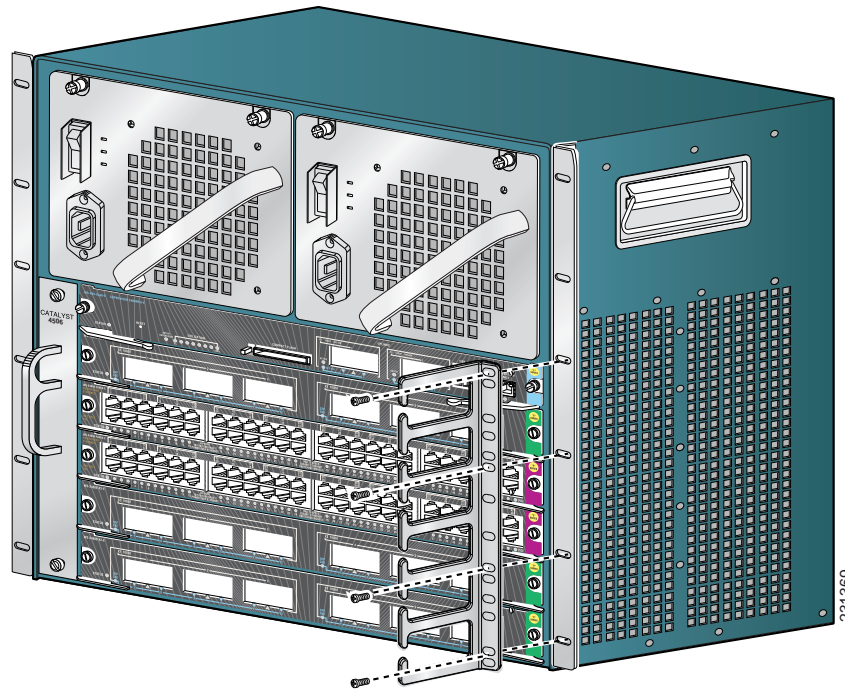

- Step 6** Verify that on all installed supervisor engines and switching modules, the ejector levers are completely closed and that the captive installation screws are tight.

Establishing the System Ground Connection

The system (NEBS) ground provides additional grounding for EMI shielding requirements and grounding for the low voltage supplies (DC-DC converters) on the modules and is intended to satisfy the Telcordia Technologies NEBS requirements for supplemental bonding and grounding connections.

Proper grounding practices ensure that the buildings and the installed equipment within them have low-impedance connections and low-voltage differentials between chassis. When you include NEBS-compliant system grounds, you reduce or prevent shock hazards, greatly reduce the chances of equipment damage due to transients, and substantially reduce the potential for data corruption.

Without proper and complete system grounding, you run the risk of increased component damage due to ESD. Additionally, you have a greatly increased chance of data corruption, system lockup, and frequent system reboot situations by not using a system (NEBS compliant) ground.

Required Tools and Parts

To connect the system ground, you need the following tools and parts:

- Grounding lug—A two-hole standard barrel lug that supports up to 6 AWG wire. The grounding lug is applied as part of accessory kit.
- Grounding screws—Two M4 x 8 mm (metric) pan-head screws that are supplied as part of the accessory kit.
- Grounding wire—Not supplied as part of the accessory kit. The grounding wire should be sized according to local and national installation requirements. Depending on the power supply and system, a 12 AWG to 6 AWG copper conductor is required for U.S. installations. Commercially available 6 AWG wire is recommended. The length of the grounding wire depends on the proximity of the switch to proper grounding facilities.
- No. 1 Phillips-head screwdriver.
- Crimping tool to crimp the grounding wire to the grounding lug.
- Wire-stripping tool to remove the insulation from the grounding wire.

Connecting System Ground



Caution

Installations that rely solely on system grounding using only an AC third-prong ground run a substantially greater risk of equipment problems and data corruption than those installations that use both the AC third-prong ground and a properly installed system (NEBS compliant) ground.

To attach the grounding lug and cable to the grounding pad, follow these steps:

- Step 1** Use a wire-stripping tool to remove approximately 0.75 inch (19 mm) of the covering from the end of the grounding wire.
- Step 2** Insert the stripped end of the grounding wire into the open end of the grounding lug.
- Step 3** Crimp the grounding wire in the barrel of the grounding lug. Verify that the ground wire is securely attached to the ground lug by holding the ground lug and gently pulling on the ground wire.
- Step 4** Locate and remove the adhesive label covering the system grounding pad on the switch chassis. (See [Figure 3-3](#).)



Note

All Catalyst 4500 E-series chassis have the system ground pad in the same location.

Figure 3-3 Connecting System Ground on the Switch

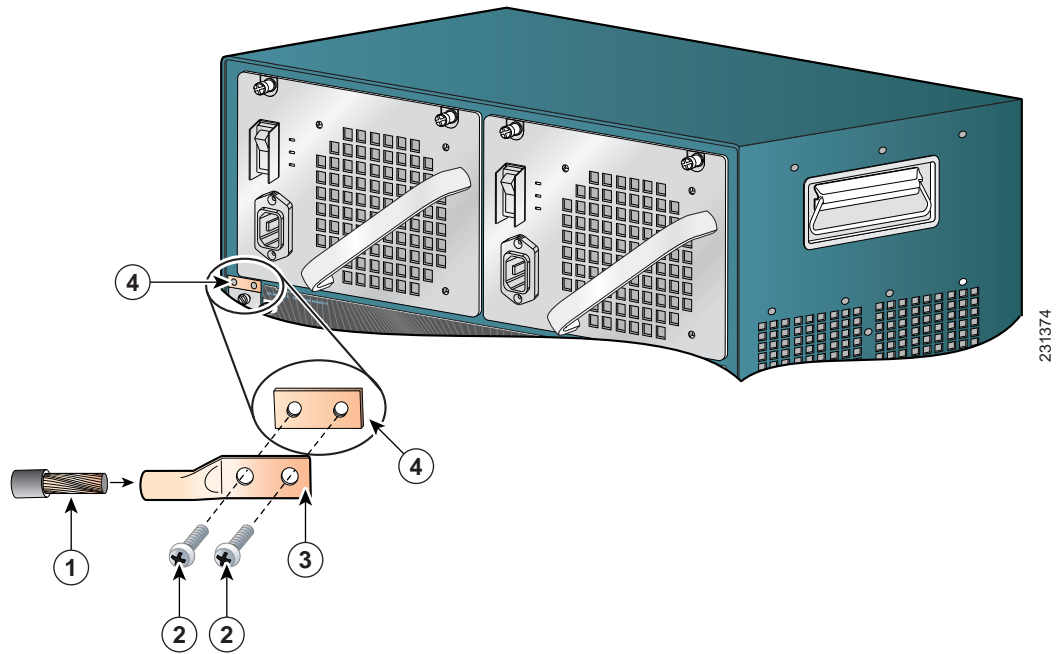

1	System grounding wire	3	Grounding lug
2	Screws (M4)	4	Chassis grounding pad

- Step 5** Place the grounding lug against the grounding pad making sure there is good metal-to-metal contact between the lug and the bare metal of the chassis and that the grounding lug and the attached wire will not interfere with other switch hardware or rack equipment.
- Step 6** Secure the system ground lug to the chassis with the two M4 screws.
- Step 7** Prepare the other end of the grounding wire and connect it to an appropriate grounding point at your site to ensure adequate earth ground for the switch. Consult with your local electrician to determine the appropriate place to attach the ground wire.

Completing the Installation Process

Perform the following procedures to complete the installation process.

Attaching the Power Cords

Verify that you have the correct power supply (AC-input or DC-input and the correct wattage) for your configuration. Connect the chassis power supplies to the site power by referring to the [“Removing and Installing the AC-Input Power Supplies”](#) section on page 4-2 or the [“Removing and Installing the DC-Input Power Supplies”](#) section on page 4-8.

Connecting the Supervisor Engine Console Port

This section describes how to connect a terminal or modem to the supervisor engine console port. The console port on the supervisor engine allows you to perform the following functions:

- Configure the switch from the CLI.
- Monitor network statistics and errors.
- Configure SNMP agent parameters.
- Download software updates to the switch, or distribute software images residing in flash memory to attached devices.

The console port is located on the front panel of the supervisor engine.



Note

The accessory kit that shipped with your Catalyst 4500 E-series switch contains the RJ-45-to-DB-25 DTE adapter, but does not contain the console cable. The console cable is available as an option.

To connect a terminal to the console port, follow these steps:

- Step 1** Place the console port mode switch in the *in* position (factory default).
- Step 2** Connect to the port using an RJ-45-to-RJ-45 cable and RJ-45-to-DB-25 DTE adapter or RJ-45-to-DB-9 DTE adapter (labeled “Terminal”).
- Step 3** Position the cable in the cable guide (if installed). Make sure there are no sharp bends in the cable.
- Step 4** Check the terminal documentation to determine the baud rate. The baud rate of the terminal must match the default baud rate (9600 baud) of the console port. Set the terminal as follows:
 - 9600 baud
 - 8 data bits
 - No parity
 - 2 stop bits

With this console connection, you can configure the switch as described in [Appendix C, “Initial Configuration for the Switch,”](#) and then as discussed in the software configuration guide appropriate for your switch’s software release, and monitor the software as the switch goes through its startup routine.



Note

If you move a supervisor engine from a Catalyst 4500 series chassis to a Catalyst 4503-E chassis or Catalyst 4506-E chassis, the supervisor engine must use Cisco IOS Release 12.2(37)SG or later releases. See your release notes for software upgrade procedures if needed:

http://www.cisco.com/en/US/docs/switches/lan/catalyst4500/release/note/OL_5184.html#wp305142

Connecting the Supervisor Engine Uplink Ports

This section describes how to connect to the supervisor engine uplink ports. Some supervisor engine uplink ports may require the installation of transceivers into the supervisor engine port sockets. Refer to the applicable transceiver installation notes for instructions on how to correctly install the transceiver into your supervisor engine uplink port.



Warning

Invisible laser radiation may be emitted from disconnected fibers or connectors. Do not stare into beams or view directly with optical instruments. Statement 1051



Warning

Class 1 laser product. Statement 1008



Note

In a redundant configuration with two supervisor engines, the uplink ports on the redundant (standby) supervisor engine are active and can be used for normal traffic like any other ports in the chassis.



CHAPTER 4

Removal and Replacement Procedures

Revised: March 2013

This chapter provides removal and replacement procedures for the following Catalyst 4500-E series field-replaceable units (FRUs):

- [Removing and Installing the AC-Input Power Supplies, page 4-2](#)
- [Removing and Installing the DC-Input Power Supplies, page 4-8](#)
- [Removing and Installing the Chassis Fan Tray Assembly, page 4-14](#)
- [Removing and Installing the Backplane Modules, page 4-16](#)
- [Installing the Remote Power Cycling Feature Control Wires \(Optional\), page 4-20](#)



Tip

For additional information about the Cisco Catalyst 4500 E-series switches (including configuration examples and troubleshooting information), see the documents listed on this page:

<http://www.cisco.com/en/US/products/hw/switches/ps4324/index.html>



Warning

Read the installation instructions before connecting the system to the power source. Statement 1004



Warning

Only trained and qualified personnel should be allowed to install, replace, or service this equipment. Statement 1030



Warning

This equipment must be grounded. Never defeat the ground conductor or operate the equipment in the absence of a suitably installed ground conductor. Contact the appropriate electrical inspection authority or an electrician if you are uncertain that suitable grounding is available. Statement 1024

**Warning**

Before working on equipment that is connected to power lines, remove jewelry (including rings, necklaces, and watches). Metal objects will heat up when connected to power and ground and can cause serious burns or weld the metal object to the terminals. Statement 43

**Warning**

Ultimate disposal of this product should be handled according to all national laws and regulations. Statement 1040

For procedures to remove and replace switching modules, see the [Catalyst 4500 Series Module Installation Guide](#).

For procedures to remove and replace supervisor engines see [Supervisor Engine Notes](#).

Removing and Installing the AC-Input Power Supplies

This section describes how to remove and install the AC-input power supplies for the Catalyst 4500-E series switches. The section contains the following topics:

- [Required Tools, page 4-4](#)
- [Removing an AC-Input Power Supply, page 4-5](#)
- [Installing an AC-Input Power Supply, page 4-7](#)

**Warning**

Hazardous voltage or energy is present on the backplane when the system is operating. Use caution when servicing. Statement 1034

[Figure 4-1](#) shows a single-input AC-input power supply, [Figure 4-2](#) shows a dual-input AC-input power supply, and [Figure 4-3](#) shows a triple-input AC-input power supply.

**Note**

The power supplies are hot-swappable, so in redundant mode, you will not need to power down the switch to replace or upgrade most power supplies. With dual power supplies running in combined mode, some chassis slots may lose power during an upgrade or power supply replacement.

Figure 4-1 AC-Input Power Supply (Single-Input)

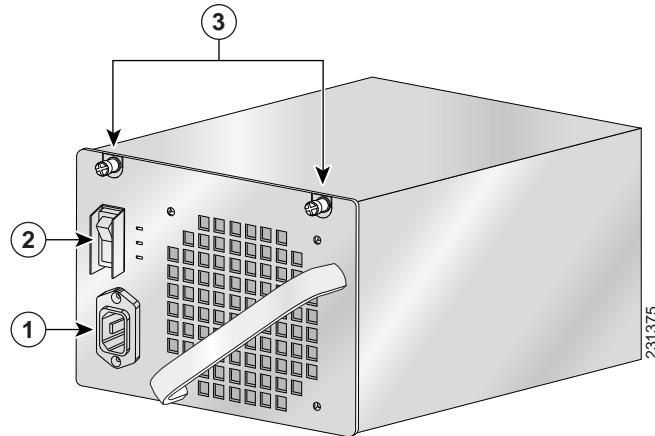

1	AC in receptacle	3	Captive installation screws
2	Power on/off switch		

Figure 4-2 Dual-Input AC-Input Power Supply (4200 W and 6000 W)

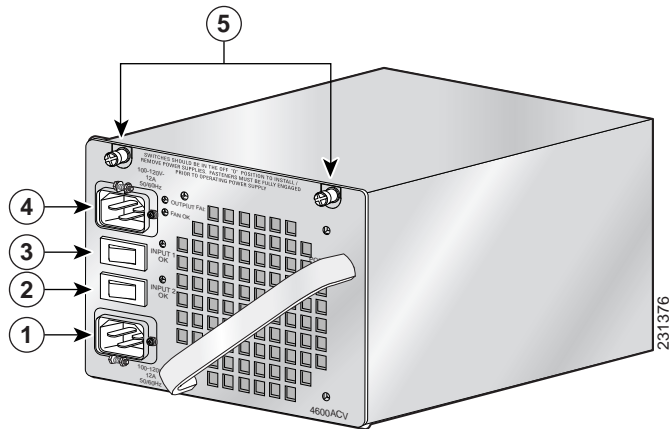

1	AC input 2 receptacle	4	AC input 1 receptacle
2	AC input 2 on/off switch	5	Captive installation screws
3	AC input 1 on/off switch		

Figure 4-3 Triple-Input AC-Input Power Supply (9000 W)

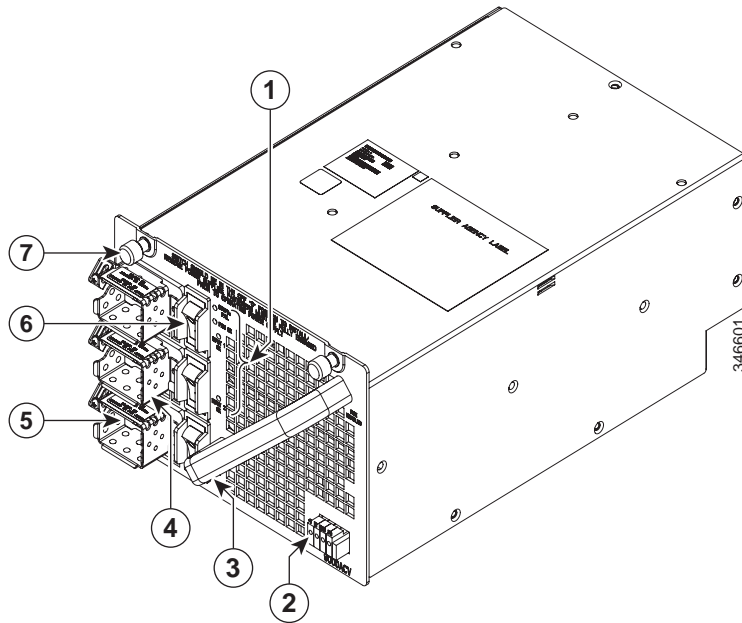

1	Power supply status LEDs	5	AC in connectors (IE60320/C20) (3 inputs)
2	Remote power cycling feature terminal block	6	AC power switches (3 switches)
3	Handle	7	Captive installation screws (2X)
4	Power cord connector retention clips		

Required Tools

You need a flathead or Phillips-head screwdriver to perform these procedures.

Removing an AC-Input Power Supply

To remove the AC-input power supply, follow these steps:

- Step 1** Set the AC-input power supply power switch to the off (0) position (see [Figure 4-4](#)).

Figure 4-4 Powering Off the Power Switch (Single-Input Power Supply Shown)

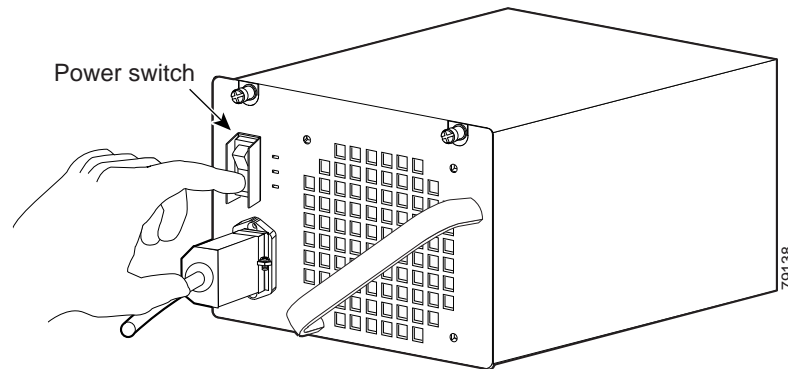

Note There are two on/off switches on the 4200 W and the 6000 W AC-input power supplies and three on/off switches on the 9000 W AC-input power supply. Each switch controls one of the source AC inputs.

- Step 2** Loosen the side-clamp screw on the power cord plug (see [Figure 4-5](#)).

Figure 4-5 Loosening the Side-Clamp Screw (Single-Input Power Supply Shown)

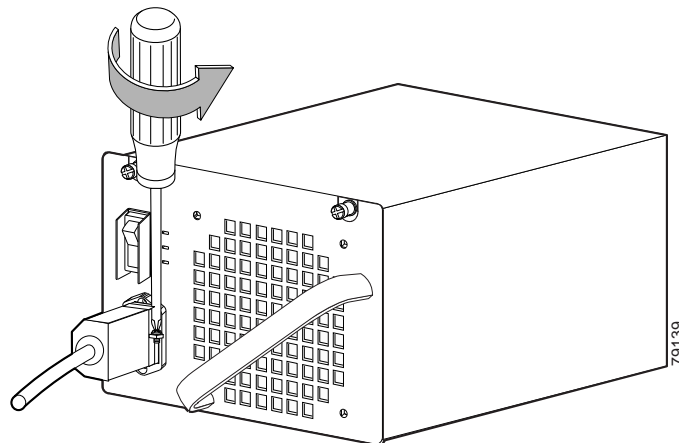

- Step 3** Disconnect the power cord appliance plug from the AC-in receptacle.
Step 4 Loosen the two captive screws on the power supply (see [Figure 4-6](#)).

Figure 4-6 Loosening the Captive Screws

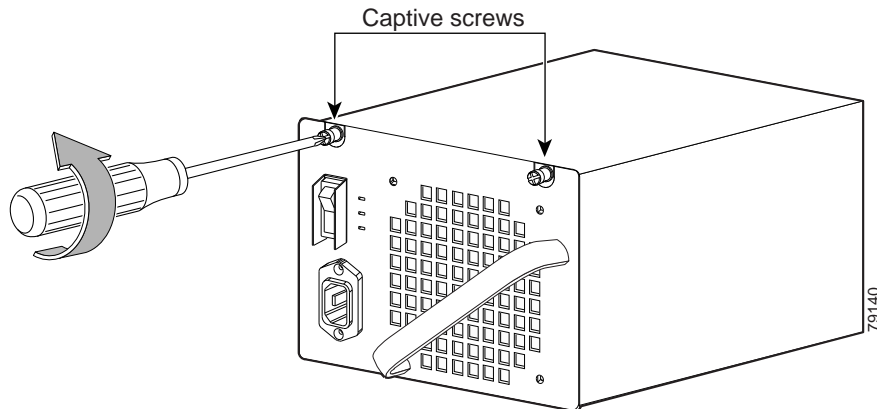

Caution Use both hands to grasp and support a power supply.

- Step 5** Grasp the power supply handle with one hand. Place your other hand underneath to support the bottom of the power supply, as shown in Figure 4-7.

Figure 4-7 Handling an AC-Input Power Supply

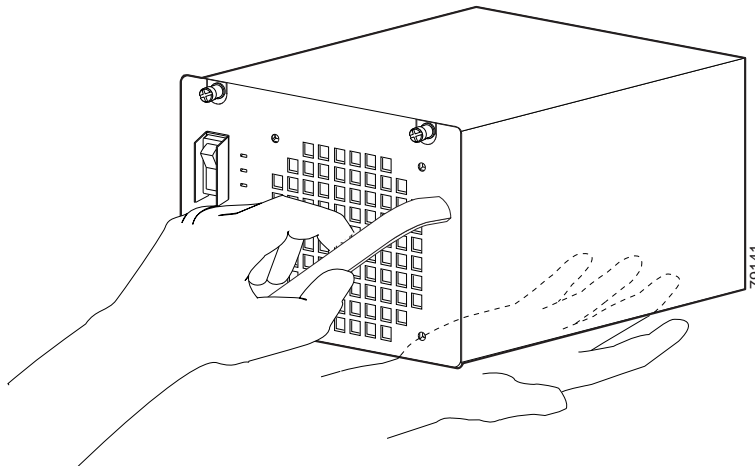

- Step 6** Slide the power supply out of the bay and set it aside.
- Step 7** If the power supply bay is to remain empty, install a blank power supply cover (WS-C4K-PS-CVR) over the opening. Secure the blank power supply cover with the two mounting screws.



Warning

Blank faceplates and cover panels serve three important functions: they prevent exposure to hazardous voltages and currents inside the chassis; they contain electromagnetic interference (EMI) that might disrupt other equipment; and they direct the flow of cooling air through the chassis. Do not operate the system unless all cards, faceplates, front covers, and rear covers are in place. Statement 1029

Installing an AC-Input Power Supply



Warning

The plug-socket combination must be accessible at all times, because it serves as the main disconnecting device. Statement 1019

To install an AC-input power supply, follow these steps:

- Step 1** Remove the replacement power supply from its shipping packaging.
- Step 2** Verify that the replacement power supply power switch is in the off (0) position.
- Step 3** If necessary, remove the blank power supply cover from the empty power supply bay by removing the two Phillips-head screws. Save the blank faceplate and the two screws for future use.



Caution

Use both hands to handle a power supply.

- Step 4** Grasp the power supply handle with one hand and place your other hand underneath to support the bottom of the power supply, as shown in [Figure 4-7](#), and slide the power supply all the way into the power supply bay. Make sure that the power supply is fully seated in the bay.
- Step 5** Tighten the two captive installation screws (see [Figure 4-1](#)) on the front panel of the AC-input power supply.
- Step 6** Before you connect the power supply to a power source, verify that all site power and grounding requirements have been met.
- Step 7** Verify that you have the correct AC power cord for your location and power supply rating. See [Appendix A, “Power Supply Specifications,”](#) for a list of supported AC power cords for your particular AC-input power supply.
- Step 8** Plug the power cord appliance connector into the power supply AC-in receptacle (see [Figure 4-8](#)) and tighten the screw on the power cord retention clip.

Figure 4-8 Plugging the Power Cord into the Power Supply (Single-Input Power Supply Shown)

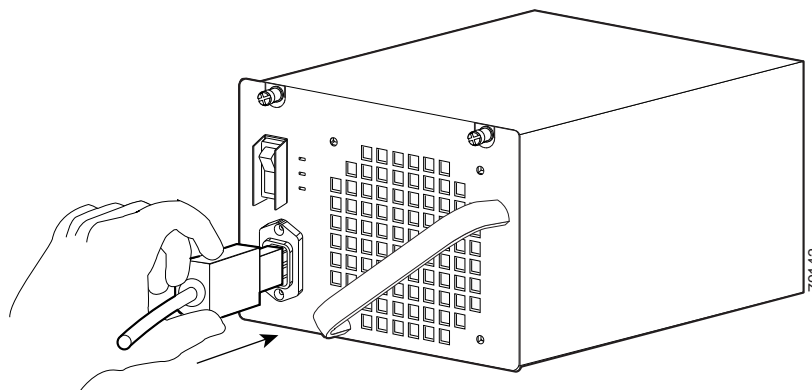

- Step 9** Plug the other end of the power cord to source AC.



Note

In a chassis with dual power supplies or power supplies with multiple AC inputs, it is recommended that you connect each AC power cord to a separate source AC circuit.

Step 10 Set the power switch to the on (I) position (see [Figure 4-9](#)).

Figure 4-9 Powering On the Power Supply (Single-Input Power Supply Shown)

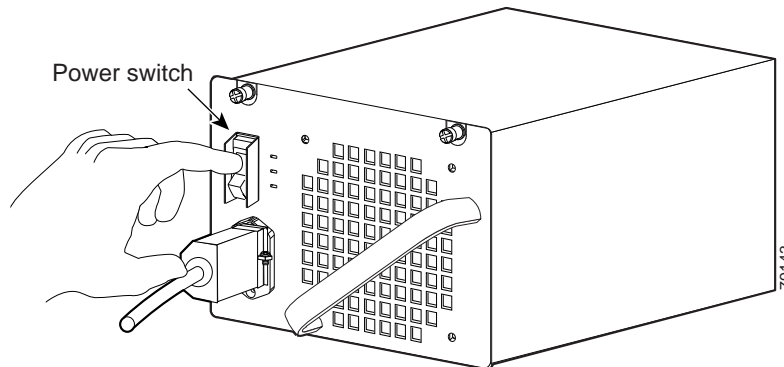

Step 11 Verify the power supply operation by checking the power supply's front-panel LEDs. You should see the following:

- The LED labeled GOOD or INPUT OK is green.
- The LED labeled OUTPUT FAIL is not lit.
- The LED labeled FAN OK is green.

Step 12 Check the power supply and system status from the system console by entering **show power** command. For more information on this command, see the command reference publication for your switch.

Step 13 If the LEDs or **show power** command output indicate a power problem or other system problem, see [Chapter 5, "Troubleshooting,"](#) for more information.

Removing and Installing the DC-Input Power Supplies

This section describes how to remove and install the DC-input power supplies and contains the following topics:

- [Required Tools, page 4-8](#)
- [Removing a DC-Input Power Supply, page 4-9](#)
- [Installing a DC-Input Power Supply, page 4-12](#)

Required Tools

You need the following tools to perform this procedure:

- A Phillips-head screwdriver
- A 10-mm wrench/socket
- Wire cutters (you might need to cut any cable ties that are installed on the power supply)

Removing a DC-Input Power Supply



Warning

Before performing any of the following procedures, ensure that power is removed from the DC circuit. Statement 1003

To remove a DC-input power supply, follow these steps:

- Step 1** Turn off the in-line power switch on the DC-input power supply front panel. (This step applies to the single input power supply only, PWR-C45-1400DC-P; the triple-input power supply, PWR-C45-1400DC, does not have this switch.)
- Step 2** Verify that power is off to the DC circuit on the power supply that you are removing. As an added precaution, place the appropriate safety flag and lockout devices at the source power circuit breaker, or place a piece of adhesive tape over the circuit breaker handle to prevent accidental power restoration while you are working on the circuit.
- Step 3** Loosen the screw on the terminal block cover, remove the cover from the terminal block, and set it aside (see [Figure 4-10](#) or [Figure 4-11](#)).



Note

The triple-input power supply has two screws securing the terminal block cover.

Figure 4-10 DC-Input Power Supply

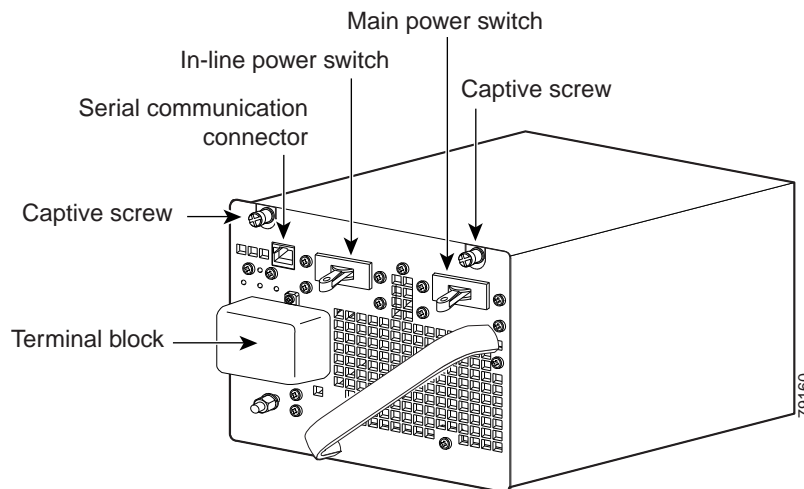
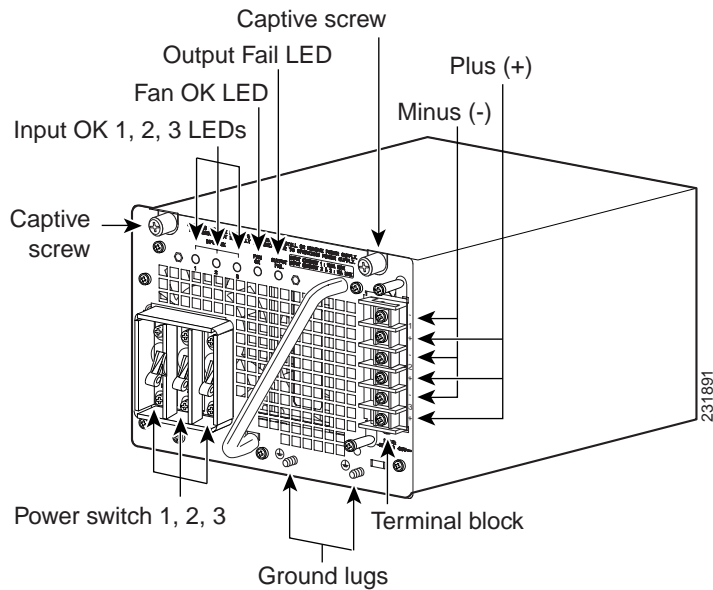

Figure 4-11 DC Triple-Input Power Supply



- Step 4** Disconnect the DC-input wires from the terminal block. Disconnect the ground wire last (see [Figure 4-12](#) or [Figure 4-13](#)).



Warning

When installing or replacing the unit, the ground connection must always be made first and disconnected last. Statement 1046

Figure 4-12 Connecting the DC-Input Wires

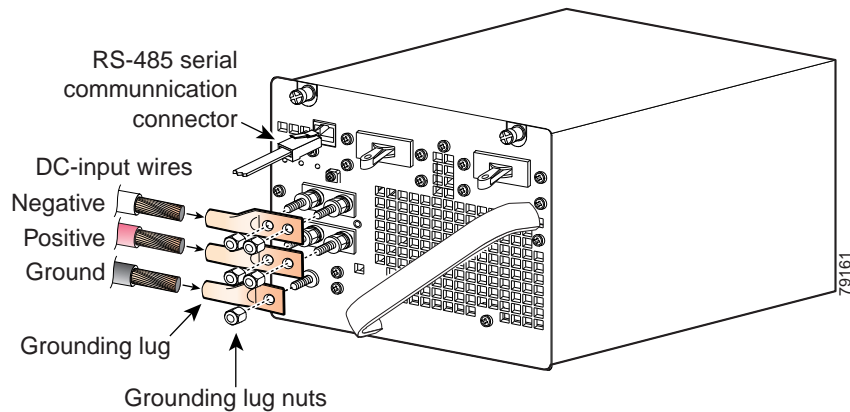
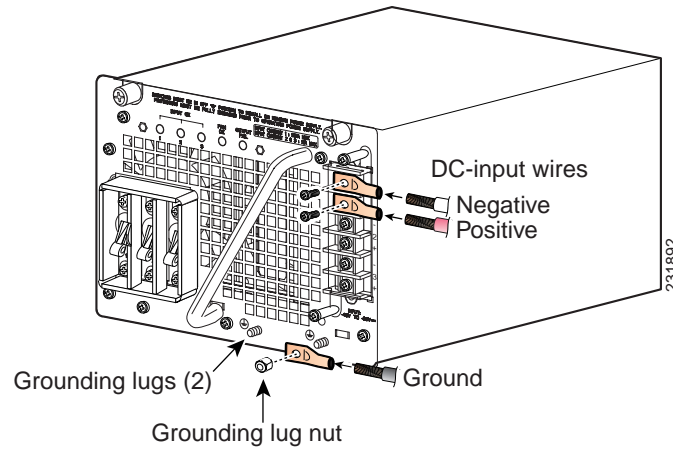
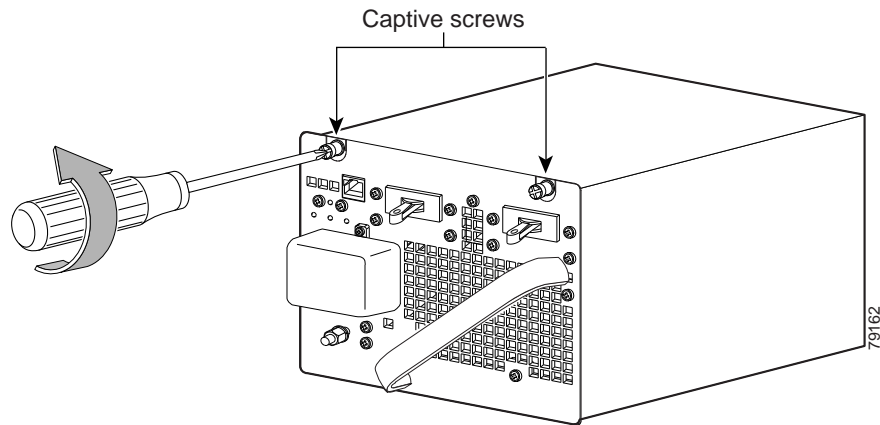

Figure 4-13 Connecting the DC-Input Wires (Triple-Input Power Supply)



- Step 5** Loosen the two captive screws on the power supply. (See [Figure 4-14](#), which shows the single-input power supply. The triple-input power supply has captive screws in the same location.)

Figure 4-14 Loosening the Captive Screws



- Step 6** Grasp the power supply handle with one hand. Place your other hand underneath as you slowly pull the power supply out of the chassis power supply bay (see [Figure 4-15](#)).

Figure 4-15 Handling a DC-Input Power Supply

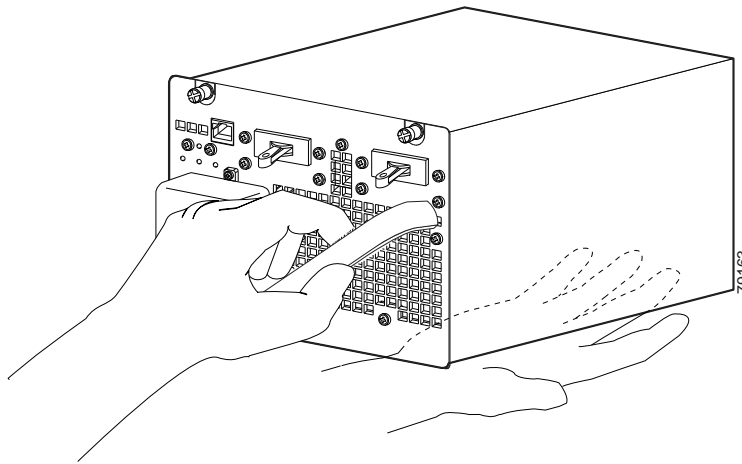

- Step 7** If the chassis power supply bay is to remain empty, install a blank power supply filler plate (WS-C4KE-PS-CVR) over the opening and secure it with the mounting screws. The blank power supply filler plate protects the inner chassis from dust and prevents accidental contact with the live voltage at the rear of the bay.

**Warning**

Blank faceplates and cover panels serve three important functions: they prevent exposure to hazardous voltages and currents inside the chassis; they contain electromagnetic interference (EMI) that might disrupt other equipment; and they direct the flow of cooling air through the chassis. Do not operate the system unless all cards, faceplates, front covers, and rear covers are in place. Statement 1029

Installing a DC-Input Power Supply

**Warning**

Before performing any of the following procedures, ensure that power is removed from the DC circuit. Statement 1003

**Warning**

A readily accessible two-poled disconnect device must be incorporated in the fixed wiring. Statement 1022

**Warning**

This product requires short-circuit (overcurrent) protection, to be provided as part of the building installation. Install only in accordance with national and local wiring regulations. Statement 1045

**Warning**

Use copper conductors only. Statement 1025

**Warning**

When stranded wiring is required, use approved wiring terminations, such as closed-loop or spade-type with upturned lugs. These terminations should be the appropriate size for the wires and should clamp both the insulation and conductor. Statement 1002

To install a DC-input power supply, follow these steps:

- Step 1** Verify that power is off to the DC circuit on the power supply that you are removing. As an added precaution, place the appropriate safety flag and lockout devices at the source power circuit breaker, or place a piece of adhesive tape over the circuit breaker handle to prevent accidental power restoration while you are working on the circuit.
- Step 2** Grasp the power supply handle with one hand. Place your other hand underneath it as you slowly insert the power supply into the bay (see [Figure 4-15](#)). Make sure that the power supply is fully seated in the bay.
- Step 3** Tighten the captive screws on the power supply (see [Figure 4-14](#)).
- Step 4** Before you connect the power supply to a power source, ensure that all site power and grounding requirements have been met.
- Step 5** Remove the terminal block cover from the terminal block.
- Step 6** Connect the source DC cables to the power supply terminal block. The proper wiring sequence is ground to ground, positive to positive, and negative to negative (see [Figure 4-12](#) or [Figure 4-13](#) depending on your installation).

The 1400W triple-input power supply has two grounding posts; use the one that is most convenient for your installation.

**Warning**

When installing or replacing the unit, the ground connection must always be made first and disconnected last. Statement 1046

- Step 7** After ensuring that all wire connections are secure, reinstall the terminal block cover.

**Caution**

In a system with multiple power supplies or a single triple-input power supply, connect each power supply to a separate DC power source. In the event of a power source failure, if the second source is still available, it can maintain maximum overcurrent protection for each power connection.

- Step 8** Remove any safety flag and lockout devices or any tape from the source DC circuit breaker switch handle and restore power by moving the circuit breaker switch handle to the on (I) position.
- Step 9** Turn the power supply power switch to the on (I) position.

- Step 10** Verify power supply operation by checking the power supply's front-panel LEDs. You should see the following:
- The LED labeled INPUT OK is green.
 - The LED labeled OUTPUT FAIL is not lit.
- Step 11** Check the power supply and system status from the system console by entering the **show power** command. For more information on the commands, see the command reference publication for your switch and software.
- Step 12** If the LEDs or the **show power** command (Cisco IOS) output indicate a power problem or other system problem, see [Chapter 5, "Troubleshooting,"](#) for more information.
-

Removing and Installing the Chassis Fan Tray Assembly

This section describes how to remove and install the chassis fan tray assembly for the Catalyst 4500 E-series switches and is contains the following topics:

- [Required Tools, page 4-14](#)
- [Removing the Fan Tray Assembly, page 4-14](#)
- [Installing the Fan Tray Assembly, page 4-15](#)

[Figure 4-16](#) illustrates the Catalyst 4506-E system fan tray assembly. The fan tray assemblies for the other chassis attach in a very similar way.

Required Tools

You will need a Phillips-head screwdriver for the following two procedures.

Removing the Fan Tray Assembly

**Warning**

When removing the fan tray, keep your hands and fingers away from the spinning fan blades. Let the fan blades completely stop before you remove the fan tray. Statement 258

**Caution**

Never operate the system for an extended period if the fan tray assembly is removed or if it is not functioning properly. An overtemperature condition can cause severe equipment damage.

To remove the existing fan tray assembly, follow these steps:

- Step 1** Loosen the two captive installation screws on the fan tray assembly.

Figure 4-16 Catalyst 4506-E System Fan Tray Assembly

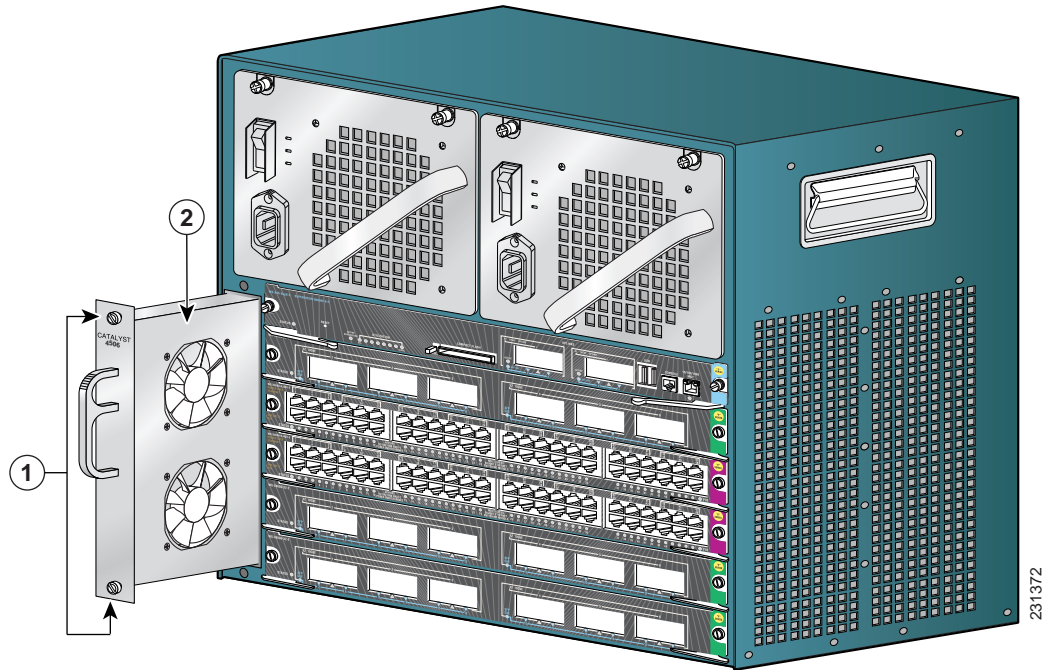

1	Captive installation screws	2	Fan tray assembly
---	-----------------------------	---	-------------------

- Step 2** Grasp the fan tray assembly handle and slide the fan tray assembly out of the chassis; gently move it side to side if necessary to unseat it from the backplane. Remove the fan tray assembly from the chassis and set it aside.

Installing the Fan Tray Assembly

To install the replacement fan tray assembly, follow these steps:

- Step 1** Remove the replacement fan tray assembly from the shipping packaging.
- Step 2** Hold the fan tray assembly with the fans facing to the right.
- Step 3** Place the fan tray assembly into the fan tray assembly bay so it rests on the chassis, and then lift the fan tray assembly up slightly, aligning the top and bottom guides.

- Step 4** Slide the fan tray assembly into the chassis until the two captive installation screws make contact with the chassis.
 - Step 5** Tighten the two captive installation screws to secure the fan tray assembly in the chassis.
-

Verifying the Installation



Note To check the operation of the fans, you need to power up the chassis.

To verify that the new fan tray assembly is installed correctly and is operating properly, follow these steps:

- Step 1** Listen for the fans; you should immediately hear them operating. If you do not hear them, ensure that the fan tray assembly is inserted completely in the chassis and that the faceplate is flush with the switch back panel.
 - Step 2** The fan tray assembly LED should light and be green.
 - Step 3** If after several attempts the fans do not operate, or if you experience trouble with the installation (for instance, if the captive installation screws do not align with the chassis holes), contact the Cisco TAC for assistance.
-

Removing and Installing the Backplane Modules

There are five redundancy modules (also called mux buffers) and one clock module on the Catalyst 4507R-E and the Catalyst 4507R+E switch chassis backplane. The Catalyst 4510R-E and the Catalyst 4510R+E have eight redundancy modules on their backplane. They are accessible from the front of the chassis by removing all of the supervisor engines, switching modules, and blank slot covers. There are two types of redundancy modules, and they are interchangeable.

The clock module replacement procedure is identical to the redundancy module replacement procedure. Both the redundancy modules and the clock modules are not hot-swappable; the switch must be shut down to replace them.

To replace the backplane modules, follow these steps:

- Step 1** Make sure that you are grounded with an ESD strap.
- Step 2** Turn off the power to the chassis.
- Step 3** Make a record of all network interface cable connections to the switch. Also, make a record of the switching modules and their slot assignments. This step will aid you when you return the system to operation after the removal and replacement procedure is completed.
- Step 4** Disconnect all of the network interface cables to the switch and carefully set them aside.
- Step 5** Remove all supervisor engines and switching modules from the chassis and carefully place each one in a separate antistatic bag or on an individual antistatic mat.

**Caution**

Do not stack modules on top of each other. This action can cause serious damage to the modules.

**Note**

Generic switching module replacement procedures are documented at http://www.cisco.com/en/US/docs/switches/lan/catalyst4500/hardware/configuration/notes/gMdCf_nt.html

- Step 6** Locate the backplane modules that you need to replace. [Figure 4-17](#) shows a front view of the backplane with the supervisor engines and switching modules removed.

Figure 4-17 Catalyst 4507R-E Backplane

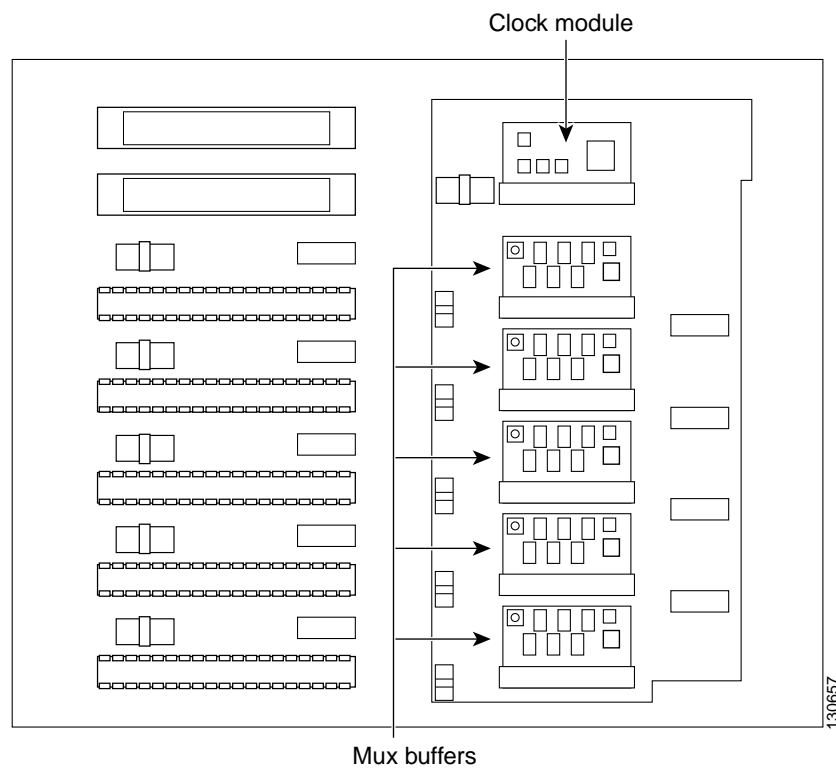

- Step 7** If you are removing a clock module, remove the two screws that secure the clock module to the backplane.
- Step 8** Locate the seating levers on both sides of the connector for the module that you want to replace. (See [Figure 4-18](#).)

Figure 4-18 Finding the Seating Levers

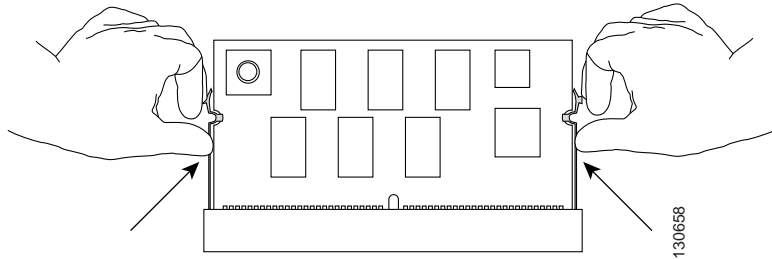

- Step 9** To release the module from its connector, pull the levers outward with your fingernails. The module will pop out slightly. (See [Figure 4-19](#).)

Figure 4-19 Releasing the Module

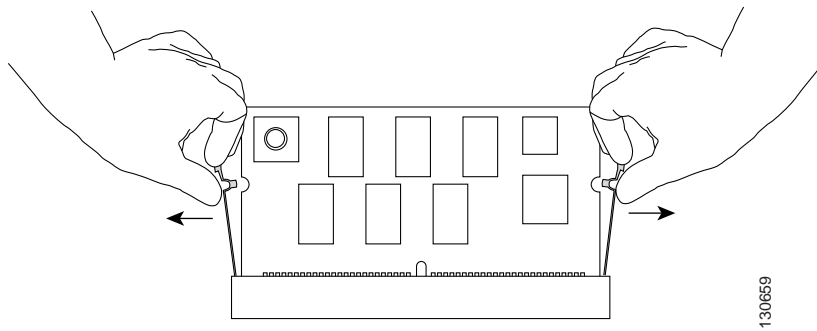

- Step 10** Pull the module out of the connector by grasping the top left and right corners. (See [Figure 4-20](#).) Place the old module in an antistatic bag or on an antistatic foam pad.

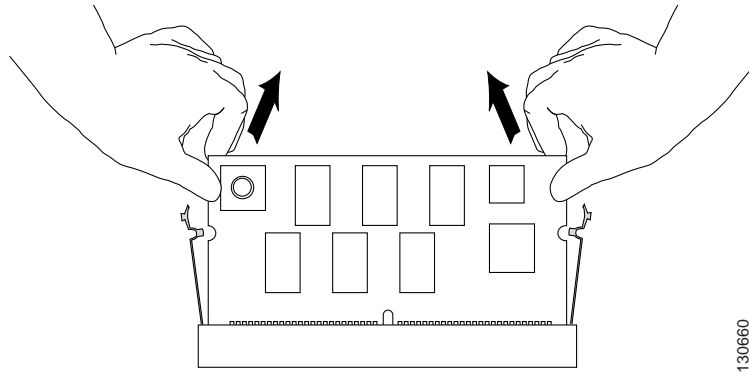

Note When handling the modules, do not touch the chips or the gold edge contacts on the module.

Figure 4-20 *Removing the Module*

Step 11 Remove the replacement module from its packaging. Be careful not to touch the chips or the gold edge contacts on the module.

Step 12 Carefully position the replacement module in the socket, and gently push the module down to seat it in the socket. Make sure that you apply force evenly on both the left and right side of the module. (See [Figure 4-21](#).)

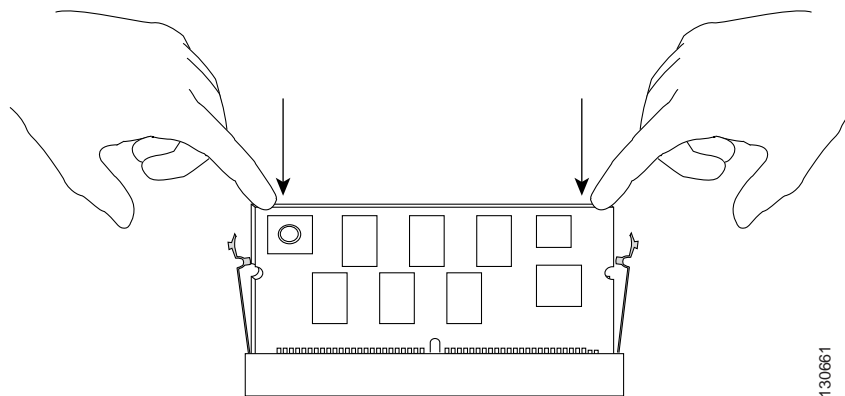
Figure 4-21 *Seating the Replacement Module*

Step 13 Make sure that the module is fully seated and that it is clipped in by the levers on both sides. (See [Figure 4-22](#).)

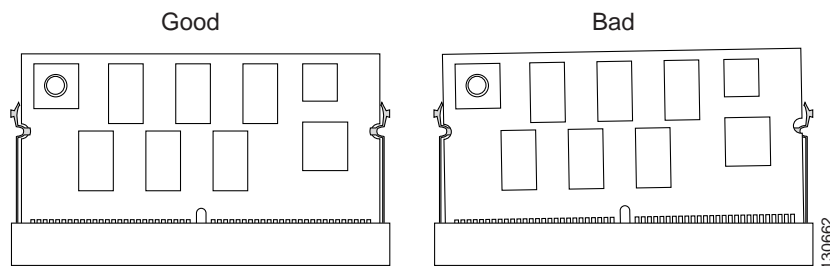
Figure 4-22 *Correct Module Seating*

Step 14 Repeat Step 6 through Step 13 for any other modules that you need to replace.

- Step 15** If you are installing a clock module, secure the module to the backplane using the two screws from the earlier removal.
- Step 16** Reinstall the supervisor engines and the switching modules in their previous slots.
- Step 17** Reconnect all of the network interface cables to the switching modules.
- Step 18** Restore power to the switch.
-

Verifying the New Modules

After the switch is reassembled and power is restored, connect a terminal to the supervisor engine and monitor the boot process. Look for the following messages (or any others), which may indicate a problem with the replaced modules:

```
00:00:20: %C4K_SUPERVISOR-2-MUXBUFFERNOTPRESENT: Mux buffer (WS-X4K-MUX) 3 is not present
00:00:20: %C4K_SUPERVISOR-2-MUXBUFFERNOTPRESENT: Mux buffer (WS-X4K-MUX) 4 is not present
00:00:20: %C4K_SUPERVISOR-2-MUXBUFFERNOTPRESENT: Mux buffer (WS-X4K-MUX) 7 is not present
```

The above messages (either at startup or output from a **show logging** command) indicate that the mux-buffer is not present in slots 3, 4 and 7. You need to reinsert and reseal the modules in those slots.

If the switch has already started up, you may also verify the correct function of the new modules with the **show logging** command.

Installing the Remote Power Cycling Feature Control Wires (Optional)

The remote power cycling feature allows you to power down and power up a switch chassis through the network rather than being physically present to turn the power supply power switch off and on. The remote power cycling feature is only available on the 6000 W and the 9000 W AC-input power supplies.

Several vendors make remote power cycling relay controller boxes that can be used to power cycle the Catalyst 4500 E-series switch chassis. Most of these relay controller boxes have the capability of controlling multiple power supplies. The relay controller boxes have a network interface that allows the user to remotely access the relay controller box and toggle a built-in relay. The built-in relay can be either a normally open (NO) type or an RS-232 type of relay. We strongly recommend that you purchase a relay controller box that uses a NO relay. The relay controller box is installed near the switch chassis and is attached to the network. Two control wires extend from the relay controller box to a four-position terminal block located on the front panel of the 6000 W and 9000 W power supplies. A signal from the relay controller box travels through the control wires to toggle the power supply on or off.

This section only describes how to install the remote power cycling feature control wires; relay controller box installation instructions should be provided by the maker of the relay controller box.

Required Tools and Components

The following tools and components are required to perform this procedure:

- Relay controller box.

We strongly recommend that you purchase a relay controller box that uses a NO (normally open) relay to control the remote power cycling.

- Small flat-blade screwdriver
- 18 AWG (maximum) control wire
- Wire cutter
- Wire stripper

Installing the Remote Power-Cycling Control Wires

To install the two control wires from the relay controller box to the 6000 W or the 9000 W power supply, follow these steps:

-
- Step 1** Remove the relay controller box from its shipping packaging.
 - Step 2** Install the relay controller box following the installation documentation supplied with the product.
 - Step 3** Measure and cut two pieces of 18 AWG control wire long enough to run between the relay controller box terminals and the terminal block on the power supply.
 - Step 4** Strip approximately 1/4-inch of insulation from each end of both control wires.
 - Step 5** Connect the two control wires to the relay controller box terminals following the instruction documentation supplied with the relay controller box.
 - Step 6** Identify which pair of terminals on the power supply terminal block (either terminals +V and IN for a NO relay (recommended) or terminals IN and GND for an RS-232 relay) where you need to connect the control wires. Using a small flat-blade screwdriver, depress the wire release mechanism for one of the terminals on the power supply terminal block and insert the bare wire into the terminal. (See [Figure 4-23](#).) Remove the screwdriver to secure the wire. Gently tug on the wire to verify that it is secure in the terminal block.
 - Step 7** Repeat Step 6 for the second control wire.

Figure 4-23 Installing the Relay Control Wires (6000 W Power Supply Shown)

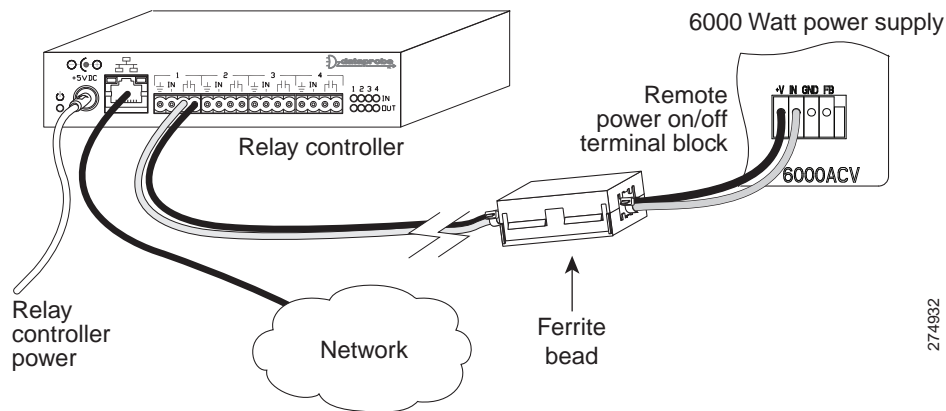

You are now ready to install the ferrite bead on the control wires. Follow the installation instructions supplied in the package containing the ferrite bead or the installation procedure in the next section.

Installing the Ferrite Bead

The ferrite bead is a passive device that limits high-frequency interference on interface and control cables, and it is only required when you install the remote power-cycling feature. The ferrite bead is installed on the two control wires that link the external relay controller box with the remote power-cycling terminal block on the 6000 W or the 9000 W power supply.

To install the ferrite bead on the remote power-cycling control wires, follow these steps:

- Step 1** Remove the ferrite bead and the two plastic ties from the plastic bag.
- Step 2** Open the ferrite bead as shown in [Figure 4-24](#), View A.
- Step 3** Place the two remote power-cycling control wires (18 AWG maximum) in the ferrite bead as shown in [Figure 4-24](#), View B. Close the ferrite bead making sure that the two halves have completely snapped together and are secure.
- Step 4** Locate a point on the remote power-cycling control wires that leaves approximately 1 to 2 inches (2.5 to 5 cm) of exposed wire from the remote power cycling terminal block located on the front of the power supply. Wrap one of the 4-inch plastic ties around the remote power-cycling control wires at that point. Tighten the plastic tie so that it is snug against the control wires and cannot slide. See [Figure 4-24](#), View C.
- Step 5** Slide the ferrite bead so that it is positioned just behind the first plastic tie wrap. Take the second plastic tie and wrap it around the control wires directly behind the ferrite bead and tighten it so that the ferrite bead cannot slide up or down the control wires. See [Figure 4-24](#), View C.
- Step 6** To finish the procedure, trim the excess plastic strap from the two plastic tie wraps.

Figure 4-24 Installing the Ferrite Bead

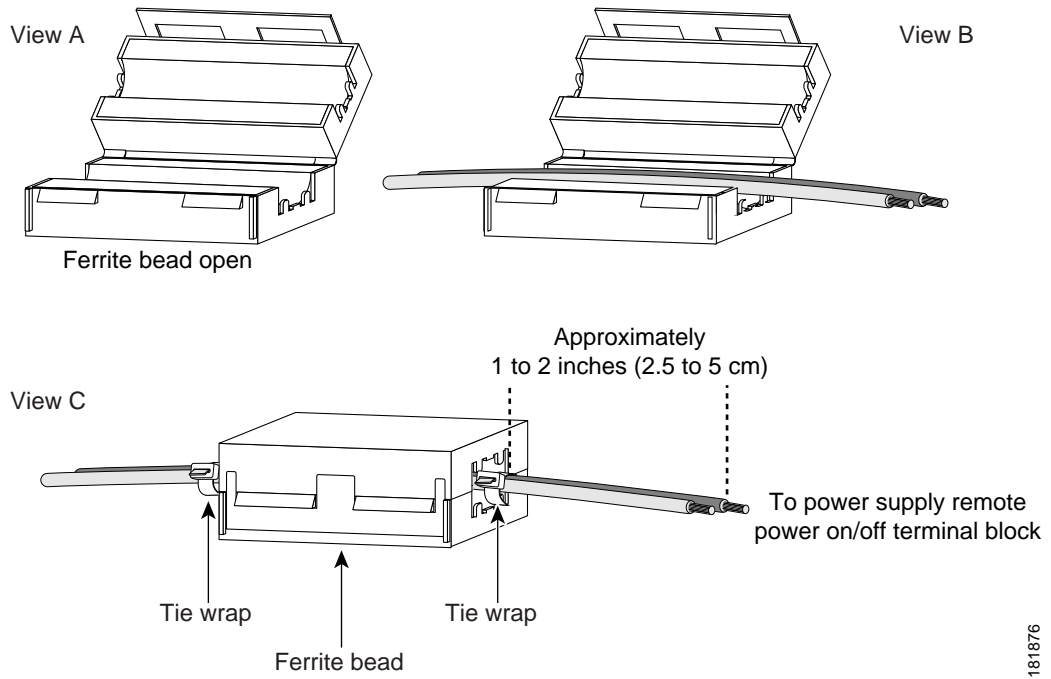

■ Installing the Remote Power Cycling Feature Control Wires (Optional)



CHAPTER 5

Troubleshooting

This chapter describes how to perform basic troubleshooting on the Catalyst 4500 E-series switch. Problems with the initial startup are often caused by a switching module that has become dislodged from the backplane or a power cord that is disconnected from the power supply.

Although temperature conditions above the maximum acceptable level rarely occur at initial startup, some environmental monitoring functions are included in this chapter because they also monitor power supply output voltages.



Note

Information about troubleshooting software features and configuration problems is not discussed in this chapter.

More up to date information can be found in the release notes or Error Message Decoder tool. Information specific to your software release can be found in the software configuration guide for that release, or in the system message guide for your release. The following links may be useful in combination with this chapter:

- Release notes

http://www.cisco.com/en/US/products/hw/switches/ps4324/prod_release_notes_list.html

- Error Message Decoder

<http://www.cisco.com/cgi-bin/Support/Errordecoder/index.cgi>

- Software configuration guide

http://www.cisco.com/en/US/products/hw/switches/ps4324/products_installation_and_configuration_guides_list.html

- System message guide

http://www.cisco.com/en/US/products/hw/switches/ps4324/products_system_message_guides_list.html

This chapter presented in the following sections:

- [System Boot Verification](#), page 5-2
- [Using LEDs to Identify Startup Problems](#), page 5-3
- [System Messages](#), page 5-4
- [Troubleshooting with Software](#), page 5-4
- [Troubleshooting the Power Supply](#), page 5-4

- [Troubleshooting the Fan Assembly, page 5-6](#)
- [Troubleshooting Backplane Modules, page 5-7](#)
- [Troubleshooting Switching Modules, page 5-8](#)
- [Troubleshooting Supervisor Engines, page 5-10](#)
- [Some Problems and Solutions, page 5-16](#)

**Note**

This chapter covers only the chassis component hardware aspects of troubleshooting. For software configuration issues, refer to the software configuration guide

http://www.cisco.com/en/US/products/hw/switches/ps4324/products_installation_and_configuration_guides_list.html

or command reference

http://www.cisco.com/en/US/products/hw/switches/ps4324/prod_command_reference_list.html

for your software release.

System Boot Verification

When the initial system boot is complete, verify the following:

- That the system software boots successfully
Hook up a terminal and view the startup banner. Use an RJ-45-to-RJ-45 rollover cable to connect the console port to a PC with terminal emulation software set for 9600 baud, 8 data bits, no parity, and 1 stop bit. Watch for any system messages after startup.
- That the power supplies are supplying power to the system
The power supply's LEDs should be green. Use the **show environment** Cisco IOS command to view power supply activity.
- That the system fan assembly is operating
Listen for fan activity. The Fan tray LED should be green during operation. Use the **show environment** Cisco IOS command to view fan tray activity.
- That the supervisor engine and all switching modules are installed properly in their slots, and that each initialized without problems

If all of these conditions are met and the hardware installation is complete, refer to the software configuration guide and command reference publications for your switch so that you can troubleshoot the software.

If any of these conditions is not met, use the procedures in this chapter to isolate and, if possible, resolve the problem.

Using LEDs to Identify Startup Problems

The key to success when troubleshooting the system is to isolate the problem to a specific system component. Your first step is to compare what the system *is doing* to what it *should be doing*. All system states in the startup sequence are indicated by LEDs. By checking the LEDs, you can determine when and where the system failed in the startup sequence. If you have problems after the switch is on, refer to the following subsystem troubleshooting information and the configuration procedures in the software configuration guide for your switch.

After you connect the power cords to your Catalyst 4500 series switch, follow these steps to determine whether your system is operating properly:

Step 1 Check the power supply LEDs:

- The LED labeled GOOD should turn green when power is applied to the supply. The LED should remain on during normal system operation.
- If the LED labeled GOOD does not light, or if the LED labeled FAIL lights, see the [“Troubleshooting the Power Supply” section on page 5-4](#).



Note If a power supply is installed and not connected to a power source, power supply LEDs indicate a failure.

Step 2 Listen for the system fan assembly. The system fan assembly should be operating whenever system power is on. If you do not hear it when the switch is on, see the [“Troubleshooting the Fan Assembly” section on page 5-6](#).**Step 3** Check that the LEDs on the supervisor engine light as follows:

- The LED labeled STATUS flashes orange once and stays orange during diagnostic boot tests.
 - It turns green when the module is operational (online).
 - If the system software is unable to start up, this LED stays orange.
 - If the LED labeled STATUS on the supervisor engine front panel is red or orange, connect a console to the management port and use the **show environment** command to check for possible problems.
- The Ethernet management port LED turns green when the module is operational (online) and a link is established with another network device. If no signal is detected, the LED labeled LINK turns off.

If there is a problem with the supervisor engine, try reseating the supervisor engine in the chassis and restarting the switch. For more troubleshooting information, see the [“Troubleshooting Supervisor Engines” section on page 5-10](#).

Step 4 Verify that the LEDs labeled STATUS on each switching module are green when the supervisor engine completes initialization.

This LED indicates that the supervisor engine and switching modules are receiving power, have been recognized by the supervisor engine, and contain a valid Flash code version. However, this LED does not indicate the state of the individual interfaces on the switching modules. If an LED labeled STATUS is red or orange, try reseating the switching module or supervisor engine and restarting the switch. For more information, see the [“Troubleshooting Switching Modules” section on page 5-8](#). If you determine that the switching module is not operating, contact Cisco TAC as described in the [“Some Problems and Solutions” section on page 5-16](#).

- Step 5** If the boot information and system banner are not displayed, verify that the terminal is set for 9600 baud, 8 data bits, no parity, and 1 stop bit and connected properly to the console port.
-

System Messages

System messages appear on the console if you have enabled console logging or appear in the syslog if you have enabled syslog. Many messages are for informational purposes only and do not indicate an error condition. Enter the **show logging** command to display the log messages. To better understand a specific system message, refer to the system message guide for your software release. Most messages are also documented in the Error Message Decoder tool at:

<http://www.cisco.com/cgi-bin/Support/Errordecoder/index.cgi>

System messages specific to the system components are mentioned in the corresponding sections that follow. If you see one of these messages, use the Decoder tool and follow the suggestion provided there.

Troubleshooting with Software

Many problems can be identified with CLI commands, and following sections will mention them as appropriate.

Certain problems can be due to not having the right software to support your hardware. For the most recent software release to get the current recommended version for a particular system component, please refer to the release notes at

http://www.cisco.com/en/US/products/hw/switches/ps4324/prod_release_notes_list.html

Troubleshooting the Power Supply

To help isolate a power subsystem problem, follow these steps:

-
- Step 1** Check whether the power supply LED labeled GOOD is on or the LED labeled FAIL is on. (on the DC multi-input power supply, the LEDs are labeled INPUT 1, 2, or 3 or OUTPUT FAIL.)
- Step 2** If the LED labeled GOOD is off or if the LED labeled FAIL is on, take the following steps:
- Ensure that the power supply is flush with the back of the chassis.
 - Unplug the power cord, loosen and reinstall the power supply, tighten the captive installation screws, and then plug in the power cord.
- Step 3** If the LED labeled GOOD remains off, there might be a problem with the AC source or the power cable. Connect the power cord to another power source if one is available. Verify that the source power is acceptable within the specifications of the power supply.
- Step 4** If the LED labeled GOOD fails to light after you connect the power supply to a new power source, replace the power cord.



Note If this unit has more than one power cord, repeat Step 1 through [Step 4](#) for each power input.

- Step 5** If the LED labeled GOOD still fails to light when the switch is connected to a different power source with a new power cord, the power supply is probably faulty. See the “[System Messages and Power Problems](#)” section on page 5-5. You may need to replace the power supply.
- Step 6** If the LED labeled FAN OK fails to light when the switch is connected to a good power source with a known good power cord, there is a malfunction in the fan that cools the power supply. Replace the power supply.
- Step 7** If a second power supply is available, install it in the second power supply bay.
- Step 8** Check that the LED labeled GOOD is on for the additional power supply. Check that the LED labeled FAIL is off.
- Step 9** If the LEDs are not on, repeat the previous procedure to troubleshoot the second power supply. If you are unable to resolve the problem, or if you determine that either a power supply or backplane connector is faulty, contact Cisco Technical support for instructions.
-

System Messages and Power Problems

Check for system messages related to the power supply, and refer to the system message guide for your software release. You may need to add a power supply or upgrade to a larger one for your current configuration or verify that the switches are set properly on the power supply. Connect a terminal to the console port, and look for any of the following system messages (there may be others, depending on the software release):

```
C4K_CHASSIS-2-INLINEPOWEROFF
C4K_IOSMODPORTMAN-4-INLINEPOWERSUPPLYBAD
C4K_IOSMODPORTMAN-4-INLINEPOWEROVERMAX
C4K_CHASSIS-2-INSUFFICIENTPOWERDETECTED
C4K_CHASSIS-2-INSUFFICIENTPOWERSHUTDOWN
C4K_CHASSIS-3-INSUFFICIENTPOWER
C4K_CHASSIS-3-INSUFFICIENTPOWERSUPPLIESDETECTED
C4K_CHASSIS-3-MIXINPOWERDETECTED
C4K_IOSMODPORTMAN-3-UNKNOWNPOWERSUPPLY
C4K_IOSMODPORTMAN-4-POWERSUPPLYBAD
C4K_IOSMODPORTMAN-4-POWERSUPPLYFANBAD
C4K_SUPERVISOR-3-POWERSUPPLYSTATUSREADFAILED
C4K_SUPERVISOR-3-POWERSUPPLYSEEPROMREADFAILED
C4K_SUPERVISOR-3-POWERSUPPLYSEEPROMINVALID
```

If you see any of these messages or other messages, go to the following location and enter the message text to find recommendations for your situation.

<http://www.cisco.com/cgi-bin/Support/Errordecoder/index.cgi>

Useful CLI Commands

You may also use the **show environment status powersupply**, **show module all**, and **show power** commands to monitor PS status, load, and activity.

If the **show module** command output shows a message that states "not enough power for module," check [Appendix A, "Power Supply Specifications,"](#) for the minimum power requirements for the power supply. There may be a problem with the power source itself.

Power Supply Mixing

The 1400 W DC multi-input supply can not be used with other power supply types, but other power supplies in this product line work with the other types during an upgrade. If you mix power supplies in a Catalyst 4500 series chassis, the switch detects the type of power supply in power supply bay 1 (PS1) and ignores the power supply in power supply bay 2 (PS2) while issuing system messages and showing the power supply in bay 2 as in the err-disable state in the output of the **show power** command. When the power supply in bay 1 is removed, the switch recognizes the power supply in bay 2, and you may then put a new matching power supply in bay 1. Both supplies should resume normal function.

Troubleshooting the Fan Assembly



Note All fans must be operating or a failure will occur.

Environmental problems may initially appear to be problems with the fan tray. To help isolate a fan assembly problem, follow these steps:

-
- Step 1** Check the status LED on the fan tray.
- If the LED is off and the rest of the system is functioning, the fan tray is not getting power or is not seated correctly on the backplane.
 - If the LED is green, the fans are operating normally. There may be conditions impairing fan performance, but they are minimal in impact.
 - If the LED is red, one or more fans have failed.
- Step 2** Connect a terminal and determine the fan tray status shown by the **show environment status** CLI command. The status and sensor columns should say *good*.
- Step 3** Determine whether the airflow is restricted or if the ambient temperature in the room is too warm.
- Step 4** Determine whether the power supply is functioning properly. See the ["Troubleshooting the Power Supply" section on page 5-4](#).
- Step 5** Verify that the fan assembly is properly seated in the backplane by loosening the captive installation screws, removing the fan assembly, and reinstalling it.
- Step 6** Restart the system.
- Step 7** Verify that all fans are operating. You should hear the fans at system start.

- Step 8** If the system is still detecting a fan assembly failure, check for details using the CLI and contact the Cisco TAC for assistance.
-

System Messages and Fan Problems

Look for system messages reporting a temperature problem or problem with the fans. Individual messages may suggest different solutions. Connect a terminal to the console port, and look for any of the following system messages:

```
C4K_CHASSIS-2-INSUFFICIENTFANSDETECTED
C4K_CHASSIS-2-INSUFFICIENTFANSSHUTDOWN
C4K_IOSMODPORTMAN-4-CRITICALTEMP
C4K_IOSMODPORTMAN-4-FANTRAYBAD
C4K_IOSMODPORTMAN-4-FANTRAYPARTIALFAILURE
C4K_IOSMODPORTMAN-4-FANTRAYREMOVED
C4K_SUPERVISOR-3-FANTRAYREADFAILED
C4K_SUPERVISOR-3-FANTRAYSEEPROMREADFAILED
C4K_SUPERVISOR-3-FANTRAYSEEPROMINVALID
C4K_IOSMODPORTMAN-4-TEMPHIGH
C4K_IOSMODPORTMAN-4-TEMPUNDERCRITICAL
C4K_CHASSIS-2-OVERHEATINGSHUTDOWN
```

If you see any of these messages or other messages related to fans, go to the following location and enter the message text to find recommendations for your situation.

<http://www.cisco.com/cgi-bin/Support/Errordecoder/index.cgi>

Useful CLI Commands

The **show environment status fantray** command can give additional information useful in diagnosing fan tray problems.

Troubleshooting Backplane Modules

The Cisco Catalyst 4500 E-series redundancy scheme uses removable redundancy modules (also called mux-buffers), on the passive backplane to switch traffic to the active supervisor engine. There is one redundancy module per switching module. Redundancy modules and a redundant clock ship standard with every Cisco Catalyst 4507R-E and 4510R-E chassis. Spare redundancy modules (**WS-X4590-E=**) and a clock module (**WS-X4K-CLOCK-E=**) are available for serviceability.

The following conditions indicate that you may need to replace the redundancy modules and clock module:

- The switch powers down and stays down for a few minutes to a few days for no clear reason.

- The output-fail LED on the power supplies are red and no power is delivered to the chassis. The other LEDs on the power supply are green.
- The Status LEDs on the switching modules and the supervisor engine are flashing green.
- CPU Utilization LEDs are flashing green or off.

If you observe these conditions, contact the Cisco TAC for assistance in ordering replacement redundancy modules and a clock.

Troubleshooting Switching Modules

Each switching module has one LED labeled STATUS that provides information about the module and one numbered LED labeled LINK for each port on the module. [Figure 5-1](#) shows the Gigabit Ethernet port and status LEDs. [Figure 5-2](#) shows the 10/100BASE-T port LEDs. [Table 5-1](#) describes the switching module LEDs and their expected behavior.

Figure 5-1 Gigabit Ethernet Port and Status LEDs

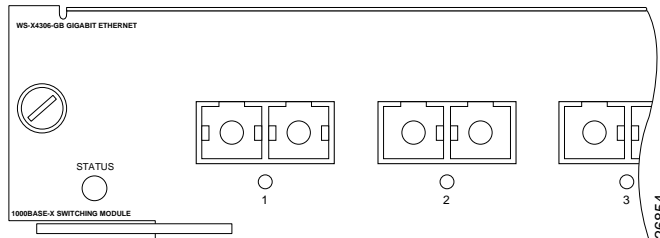

Figure 5-2 10/100BASE-T Port LEDs

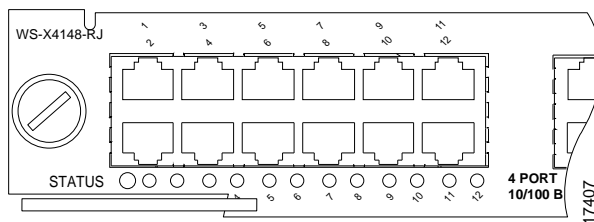

Table 5-1 Switching Module LEDs

LED	Color/State	Description
STATUS		Indicates the results of a series of self-tests and diagnostic tests performed by the switch.
	Green	All the tests pass.
	Red Orange	A test other than an individual port test failed. System boot, self-test diagnostics running, or the module is disabled.
LINK		Indicates the status of the port.
	Green	The port is operational (a signal is detected).

Table 5-1 Switching Module LEDs (continued)

LED	Color/State	Description
	Orange	The link has been disabled by software.
	Flashing orange	The link has been disabled due to a hardware failure.
	Off	No signal is detected.
Port Status ¹		Indicates individual port status.
	Green	The port is operational (a signal is detected).
	Orange	The link has been disabled by software.
	Flashing orange	The link has been disabled due to a hardware failure.
	Off	No signal is detected.

1. LEDs labeled 1 through the number of ports on the switching module are the individual port link LEDs.

System Messages and Switching Modules

Connect a terminal to the console port, and look for any of the following system messages:

C4K_CHASSIS-3-LINECARDMUXBUFFERTOSUPALIGNMENTWRONG

C4K_CHASSIS-3-LINECARDNOTVALIDINSLOT

C4K_CHASSIS-3-MODULENOTSUPPORTHALF

C4K_IOSINTF-5-STALEPHYPORT

C4K_IOSMODPORTMAN-4-INLINEPOWEROVERMAX

If you see any of these messages or other messages, go to the following location and enter the message text to find recommendations for your situation.

<http://www.cisco.com/cgi-bin/Support/Errordecoder/index.cgi>

Useful CLI Commands

Some problems can be solved by resetting the switching module. Use the **hw-module module <n> reset** command to reset a switching module, or remove and re-insert the switching module, which resets, restarts, and power cycles the switching module. The **show module** and **show diagnostics online module** commands can also provide information useful in solving problems with ports on individual modules.

Not all software versions support all switching modules. If you are having trouble with a module, refer to the software release notes to be sure that it is supported by your software.

Troubleshooting Supervisor Engines

This section only addresses problems with hardware. Problems with features or configuration are not covered here. Refer for your software configuration guide and release notes for information on configuring features or identifying known problems.

Table 5-2 describes the supervisor engine LEDs. Check the LEDs on your supervisor and compare them to the described LED behaviors.

Table 5-2 *Supervisor Engine LEDs*

LED	Color/State	Description
STATUS	Green	Indicates the results of a series of self-tests. All diagnostic tests passed.
	Red	A test failed.
	Orange	System boot or diagnostic test is in progress.
	Off	Module is disabled.
UTILIZATION	Green 1–100%	If the switch is operational, this display indicates the current traffic load over the backplane (as an approximate percentage).
LINK	Green	Indicates the status of the 10/100BASE-T Ethernet management port or uplink ports. The link is operational.
	Orange	The link is disabled by user.
	Flashing orange	The power-on self-test indicates a faulty port.
	Off	No signal is detected or there is a link configuration failure.
ACTIVE	Green	Indicates whether the uplink port is active or not. The port is active.
	Off	The port is not active.
ACTIVE		The LED to the right of the uplink ports is used to identify the active supervisor engine in switches with two supervisor engines.

The Supervisor Engine LED would turn amber or orange under the following conditions:

- Power supply failure (not the same as removal of power supply)
- Power supply fan failure
- Removal or failure of fan tray
- Mismatched power supplies in the chassis

System Messages and Supervisor Engines

Connect a terminal to the console port, and look for any of the following system messages:

C4K_CHASSIS-3-LINECARDMUXBUFFERTOSUPALIGNMENTWRONG
C4K_SUPERVISOR-3-MUXBUFFERREADSUPERVISORSELECTIONFAILED
C4K_CHASSIS-3-TEMPERATURESENSORREADFAILED
C4K_HW-3-X2IDENTIFICATIONFAILURE
C4K_HW-3-X2OUIREGREADFAILURE
C4K_HWACLMAN-4-CLASSIFCAMPARITYERROR
C4K_HWACLMAN-4-CLASSIFCAMREPLYPARITYERROR
C4K_HWACLMAN-4-CLASSIFCAMREQPARITYERROR
C4K_HWNETHFLOWMAN-3-NETFLOWSTOPPED
C4K_HWNETHFLOWMAN-4-FATALERRORINTERRUPTSEEN
C4K_HWNETHFLOWMAN-4-NONFATALPARITYERRORINTERRUPTSEEN
C4K_IOSMODPORTMAN-4-NFLABSENT
C4K_IOSMODPORTMAN-4-NFLIDPROMINVALID
C4K_IOSMODPORTMAN-4-NFLMISMATCH
C4K_REDUNDANCY-2-HANDSHAKE_TIMEOUT
C4K_REDUNDANCY-2-POSTFAIL_RESET
C4K_REDUNDANCY-2-INCOMPATIBLE_SUPERVISORS
C4K_REDUNDANCY-2-IOS_VERSION_CHECK_FAIL
C4K_REDUNDANCY-2-IOS_VERSION_INCOMPATIBLE
C4K_REDUNDANCY-2-NON_SYMMETRICAL_REDUNDANT_SYSTEM
C4K_REDUNDANCY-2-POSTFAIL
C4K_REDUNDANCY-2-POSTFAIL_RESET
C4K_REDUNDANCY-4-CONFIGSYNCFAIL
C4K_SUPERVISOR-2-SUPERVISORSEEPROMINVALID
C4K_SUPERVISOR-3-RETIMERDISABLEFAILED
C4K_SUPERVISOR-3-RETIMERINITFAILED
C4K_SUPERVISOR-3-SEEPROMREADFAILED
C4K_SUPERVISOR-4-INLINEVOLTAGEOUTOFRANGE
C4K_SUPERVISOR-7-SEEPROMWRITEFAILED
C4K_SWITCHMANAGER-3-SSOACTIVEPORTACKTIMEOUT
C4K_SYSMAN-2-POWERONSELFTESTFAIL

These system messages indicate a problem with the supervisor engine. Some problems will prevent a console connection and will not allow you to use messages in diagnosing a problem. If you are unable to establish a terminal connection and the STATUS LED is red, contact Cisco TAC immediately to order a replacement.

Problems with redundant supervisor systems are often due to mismatched active and standby supervisor engines. Redundancy requires that both supervisor engines be the same model, have the same amount of SDRAM memory and running the same Cisco IOS release. If one supervisor has a NetFlow service card, the other must as well.

Some problems with supervisor engines are due to backplane connections that are not fully seated. If removing and reinserting the supervisor engine and then restarting the switch does not solve the problem, you may need to call Cisco TAC and replace the supervisor engine.

Useful CLI Commands

Some problems can be solved by resetting the supervisor engine. Use the **hw-module module <n> reset power-cycle** command to reset a switching module, or remove and re-insert the switching module, which resets, restarts and power cycles the switching module. Pressing the reset button on the supervisor engine causes the software to reload, but does not power cycle the supervisor engine.



Note

When you power-cycle or remove a supervisor engine in a redundant system the other supervisor engine becomes the active supervisor and the ports retain connectivity. In a non-redundant system, all of the switching modules lose connectivity until the supervisor engine is reinserted and completely restarted.

The **show diagnostics power-on** command may provide useful information for some supervisor engine problems.

Not all software versions support all supervisor engines. If you are having trouble with a supervisor engine, refer to the software release notes to be sure that it is supported by your software.

Standby Supervisor Engine Problems

If the standby supervisor engine module is not online or status indicates “other” or “faulty” in the output of the **show module** command or an amber status LED, create a console connection to the standby supervisor engine and verify that it is in ROMmon mode or in continuous reboot. If the standby supervisor engine is in either of these two states, refer to:

http://www.cisco.com/en/US/products/hw/switches/ps663/products_configuration_example09186a0080094ecf.shtml

```
switch# show module
```

Mod	Ports	Card Type	Model	Serial No.
1	2	1000BaseX (GBIC) Supervisor(active)	WS-X4515	JAB0627065V
2		Standby Supervisor		
3	48	10/100/1000BaseTX (RJ45)	WS-X4448-GB-RJ45	JAB053606AG
4	48	10/100BaseTX (RJ45)V	WS-X4148-RJ45V	JAE060800BL

M	MAC addresses	Hw	Fw	Sw	Status
1	0009.e845.6300 to 0009.e845.6301	0.4	12.1(12r)EW	(12.1(12c)EW, EAR	Ok
2	Unknown		Unknown	Unknown	Other
3	0001.6443.dd20 to 0001.6443.dd4f	0.0			Ok
4	0008.2138.d900 to 0008.2138.d92f	1.6			Ok

Make sure that the supervisor engine module properly seats in the backplane connector and that you have completely screwed down the captive screws for the supervisor engine.

In order to determine whether the standby supervisor engine is faulty, enter the **redundancy reload peer** command from the active supervisor engine and through the console to the standby supervisor engine. Observe the bootup sequence in order to identify any hardware failures. Currently, the active supervisor engine cannot access the power-on diagnostics results of the standby supervisor engine.

Make sure that these configurations are synchronized between the active and redundant supervisor engines:

- Startup configuration
- Boot variable
- Configuration register
- Calendar
- VLAN database

If a software upgrade is performed on both the active and standby supervisor engines, verify that both supervisor engines are running the same new software image. If the software images are not the same, upgrade the software image. Use the procedure in the software configuration guide for your release.

If the standby supervisor engine still does not come on line, create a service request with Cisco Technical Support. Use the log of the switch output that you collected from the previous troubleshooting steps.

Switch Self-reset

If the switch has reset or rebooted on its own, verify that the power source for the switch did not fail. If you use an uninterruptable power supply (UPS), make sure that the UPS does not have any problems.

The switch might have had a software crash. Enter the **more crashinfo:data** command to display the crash information including date and time of the last time that the switch crashed. To display the standby supervisor engine crash data, enter the **more slavecrashinfo:data** command. The crash data are not present if the switch has never crashed.

```
Switch# more crashinfo:data
Current time: 04/21/2000 19:58:10
```

```
Last crash: 04/21/2000 03:58:56
```

```
!--- Output suppressed.
```

If the output indicates a software crash at the time that you suspect that the switch rebooted, the problem can be something other than a hardware failure. Contact Cisco Technical Support with the output of these commands:

- **show tech-support**
- **show logging**
- **more crashinfo:data**

If you are still unable to determine the problem, contact Cisco Technical Support.

Supervisor Ports Do Not Function

If you have dual supervisor engines in a Catalyst 4507R-E or a Catalyst 4510R-E chassis and some uplink ports on the supervisor do not function, the system is functioning as designed, which is to have two uplinks operational at all times. The dual uplinks must also work when only one supervisor engine is present. This means that if only one supervisor engine is present and is in slot n, both ports n/1 and n/2 are functional. Also, if only one supervisor engine is present and is in slot n+1, ports n+1/1 and n+1/2

are functional. When dual supervisor engines are present, only ports n/1 and n+1/1 are functional and n/2 and n+1/2 are not functional. For more information, refer to the redundancy chapter in the software configuration guide.

Packet Loss

If your system exhibits partial or full loss of network connectivity or packet loss, perform basic troubleshooting procedures to eliminate the common causes. The common causes include:

- Bad cabling
- A bad port
- Speed and duplex mismatch
- Network interface card (NIC) issues

If you troubleshoot these common reasons and you are not able to narrow down the problem, follow the steps in this section and capture the output of commands at each step, then contact Cisco Technical Support for additional troubleshooting assistance.

Step 1 Enter the **show platform software interface all** command when you observe packet loss.

Step 2 Enter the **show platform software interface all | include DroppedBadPackets** command multiple times and look for increments in the DroppedBadPackets counter, as seen in this example:

```
cat4k#show platform software interface all | include DroppedBadPackets
DroppedBadPackets : 8004
cat4k#
```

```
cat4k#show platform software interface all | include DroppedBadPackets
DroppedBadPackets : 8130
cat4k#
```

These counters are only visible if they have a nonzero value, so if you enter the command and do not see any output, your switch does not exhibit the problem. Here is an example:

```
cat4k#show platform software interface all | include DroppedBadPackets
cat4k#
```

If you see increments in the TxCrcErrors or DroppedBadPackets counters, continue to Step 2.

Step 3 Enter the **show platform cpu packet statistics** command multiple times and look for increments in the VlanZeroBadCrc counter. Here is an example:

```
cat4k#show platform cpu packet statistics | include VlanZeroBadCrc
VlanZeroBadCrc      94471          9          9          8
7
cat4k#
```

```
cat4k#show platform cpu packet statistics | include VlanZeroBadCrc
VlanZeroBadCrc      94545          9          9          8
7
cat4k#
```

Step 4 If both Step 2 and Step 3 show symptoms of packet loss, enter the **reload** command to soft reset the switch, and observe the power-on self test (POST) results at system reset. Capture all the output as a text file.

```
cat4k#reload
Proceed with reload? [confirm]
```

```

1d21h: %SYS-5-RELOAD: Reload requested
<output truncated>
Decompressing the image : #####
##### [OK]

k2diags version 1.6

prod: WS-X4014 part: 73-6854-09 serial: JAB0620090U

Power-on-self-test for Module 1: WS-X4014
Status: (. = Pass, F = Fail)

Traffic using serdes loopback (L2; one port at a time)...
switch port 0: .      switch port 1: .      switch port 2: .
switch port 3: .      switch port 4: .      switch port 5: .
switch port 6: .      switch port 7: .      switch port 8: .
switch port 9: .      switch port 10: .     switch port 11: .
switch port 12: .     switch port 13: .     switch port 14: .
switch port 15: .     switch port 16: .     switch port 17: .
switch port 18: .     switch port 19: .     switch port 20: .
switch port 21: .     switch port 22: .     switch port 23: .
switch port 24: .     switch port 25: .     switch port 26: .
switch port 27: .     switch port 28: .     switch port 29: .
switch port 30: .     switch port 31: .

Traffic using asic loopback (L2; all ports at once)...
switch port 0: F      switch port 1: F      switch port 2: F
switch port 3: F      switch port 4: F      switch port 5: F
switch port 6: F      switch port 7: F      switch port 8: F
switch port 9: F      switch port 10: F     switch port 11: F
switch port 12: F     switch port 13: F     switch port 14: F
switch port 15: F     switch port 16: F     switch port 17: F
switch port 18: F     switch port 19: F     switch port 20: F
switch port 21: F     switch port 22: F     switch port 23: F
switch port 24: F     switch port 25: F     switch port 26: F
switch port 27: F     switch port 28: F     switch port 29: F
switch port 30: F     switch port 31: F

Traffic using asic loopback (L3; all ports at once)...
switch port 0: F      switch port 1: F      switch port 2: F
switch port 3: F      switch port 4: F      switch port 5: F
switch port 6: F      switch port 7: F      switch port 8: F
switch port 9: F      switch port 10: F     switch port 11: F
switch port 12: F     switch port 13: F     switch port 14: F
switch port 15: F     switch port 16: F     switch port 17: F
switch port 18: F     switch port 19: F     switch port 20: F
switch port 21: F     switch port 22: F     switch port 23: F
switch port 24: F     switch port 25: F     switch port 26: F
switch port 27: F     switch port 28: F     switch port 29: F
switch port 30: F     switch port 31: F

Module 1 Failed
Exiting to ios...

```

This example shows a supervisor engine module diagnostic failure.

-
- Step 1** If Step 4 results in a supervisor engine module diagnostic failure, pPower cycle the switch and observe the POST results at bootup.

- Step 2** Enter the **show diagnostics power-on** command to verify the POST results from bootup and determine if diagnostics fail again. If diagnostics fail again, the problem is most likely hardware. Contact Cisco Technical Support for further assistance. If the supervisor engine passes the diagnostic tests without any failure after the power cycle in Step 4, perform these steps:
- a. Collect the output from the **show tech-support** command.
 - b. Remove all power supplies from the box, and collect the serial numbers, Cisco part number, and manufacturer of the power supplies.
 - c. Contact Cisco Technical Support with the information that you collected.



Note If Cisco Technical Support did not assist with the troubleshoot procedure, you must provide the information in the order of these steps.

Some Problems and Solutions

Module Not Online

Part or all of the module can fail to come online. You may have a module failure if you see a red status LED or if you see one of these statuses in the output of the **show module** command:

- other
- faulty
- err-disable
- power-deny
- power-bad

Make sure that the module is properly seated and that you have completely screwed down the module. If the module still does not come online, enter the **hw-module slot slot number reset** command. If the module still does not come online, try the module in a spare slot, swap the module with the slot of a module that works, or try the module in a different chassis.

If the status is “power-deny,” the switch does not have enough power available to power this module. Enter the **show power** command in order to confirm whether enough power is available. For more information, refer to the “Environmental Monitoring and Power Management” chapter in the software configuration guide for your software release.

If the status is “power-bad,” the switch detects a switching module but is unable to allocate power. This situation is possible if the supervisor engine cannot access the serial PROM (SPROM) contents on the module in order to determine the identification of the line card. Enter the **show idprom module slot** command to verify that the SPROM is readable. If the SPROM is not accessible, reset the module.

Enter the **show diagnostics online module slot number** command to identify hardware failures on the module. If the module still does not come online, create a service request with Cisco Technical Support in order to troubleshoot further. Use the log of the switch output that you collected in the above output and the troubleshooting steps that you performed.

Interface Problems

If you see an error mentioned in the output of the **show interface** command, the reason could be:

- A physical layer problem, such as a faulty cable or NIC
- A configuration problem, such as a speed and duplex mismatch
- A performance problem, such as an oversubscription

In order to understand and troubleshoot these problems, refer to *Troubleshooting Switch Port and Interface Problems* at:

http://www.cisco.com/en/US/products/hw/switches/ps708/products_tech_note09186a008015bfd6.shtml

Workstation Is Unable to Log In to the Network

If you observe that a workstation is unable to log into the network during startup or unable to obtain the DHCP address when you have powered up a client machine or rebooted, an initial connectivity delay that the switch introduced could be the problem. To verify this, check the following:

- Microsoft network client displays "No Domain Controllers Available".
- DHCP reports "No DHCP Servers Available."
- A Novell Internetwork Packet Exchange (IPX) network workstation does not have the Novell login screen upon bootup.
- An AppleTalk network client displays, "Access to your AppleTalk network has been interrupted. In order to reestablish your connection, open and close the AppleTalk control panel." The AppleTalk client chooser application can either fail to display a zone list or display an incomplete zone list.
- IBM Network stations can have one of these messages:
 - NSB83619—Address resolution failed
 - NSB83589—Failed to boot after 1 attempt
 - NSB70519—Failed to connect to a server

The reason for these symptoms can be an interface delay that either Spanning Tree Protocol (STP), EtherChannel, trunking, or an autonegotiation delay causes.

NIC Compatibility Issues

You can have NIC compatibility or misconfiguration issues with the switch if you experience one of these symptoms:

- A server or client connection to the switch does not come up
- Autonegotiation issues
- Errors on the port

The reason for these symptoms can be a known NIC driver issue, speed and duplex mismatch, or autonegotiation or cabling problems. For more troubleshooting information, refer to:

http://www.cisco.com/een/US/products/hw/switches/ps708/products_tech_note09186a00800a7af0.shtml

If you still have issues after you review and follow the procedure in the document *Troubleshooting Cisco Catalyst Switches to NIC Compatibility Issues*, contact Cisco Technical Support for further assistance.

Interface Is in Errdisable

If the interface status is err-disable in the output of the **show interface status** command, some possible reasons include:

- Duplex mismatch
- Port channel misconfiguration
- Bridge protocol data unit (BPDU) guard violation
- UniDirectional Link Detection (UDLD) condition
- Late-collision detection
- Link-flap detection
- Security violation
- Port Aggregation Protocol (PAgP) flap
- Layer Two Tunneling Protocol (L2TP) guard
- DHCP snooping rate-limit

In order to troubleshoot these scenarios, refer to the specific feature information in the *Catalyst 4500 Series Switch Cisco IOS Software Configuration Guide* for your software release.

Faulty Supervisor Engine

If the supervisor engine STATUS LED is red, establish a console connection to the supervisor engine and enter the **show diagnostics power-on** command, if you can. If you are unable to get a console connection or the command output indicates a failure, contact Cisco Technical Support.

If the switch does not boot and fails self diagnostics during the boot sequence, capture the console output of the startup sequence then contact Cisco Technical Support.

If you do not see any hardware failure in the boot sequence or in the output of the **show diagnostics power-on** command, contact Cisco Technical Support.

Boot Problems

If the switch is in a continuous boot loop, is in ROMmon mode, or does not have a system image, there is mostly likely not a hardware problem. The supervisor engine operates in a continuous loop if you have not set the boot variable correctly and you have set the configuration register to 0x2102. For instructions on how to recover the supervisor engine, refer to the “Recovering from a Continuous Reboot” section of the document at this location:

http://www.cisco.com/en/US/products/hw/switches/ps663/products_configuration_example09186a0080094ecf.shtml

The supervisor engine goes into ROMmon mode or fails to boot when the system image is either corrupt or absent. For instructions on how to recover the supervisor engine, refer to the “Recovering from a Corrupt or Missing Image” section of the document at this location:

http://www.cisco.com/en/US/products/hw/switches/ps663/products_configuration_example09186a0080094ecf.shtml

The supervisor engines have onboard system Flash memory (bootflash), which should easily hold multiple system images. Therefore, have a backup image. In addition to the bootflash, the supervisor engine supports up to 128 MB of compact Flash in the slot0: device. The supervisor engine also provides for transfer via TFTP of the image from ROMmon mode, which enables faster recovery of absent or corrupt images.

Cannot Connect to a Switch Through the Console Port

Make sure you are using the correct type of cable. Make sure the terminal configuration matches the switch console port configuration—default console port settings are 9600 baud, 8 data bits, no parity, 1 stop bit. Make sure the cable pinouts are correct for your supervisor engine (refer to the hardware documentation for your supervisor engine).

Cannot communicate with another device, Cannot Telnet to the switch, Cannot communicate with a local or remote host

Follow these steps:

-
- Step 1** Make sure the LINK LED for the port is green.
 - Step 2** Check the cabling:
 - Host-to-switch 10BASET connections and router-to-switch 10BASET or 100BASETX connections typically are made using a straight-through cable.
 - Switch-to-switch connections typically are made using a rollover cable.
 - For SC- or ST-type fiber connections, make sure transmit (Tx) on one end of the link connects to receive (Rx) on the other end of the link.
 - Step 3** Make sure the interface you are connecting to (sc0 or me1) is configured UP (use the **show interface** command to check).
 - Step 4** Make sure the IP address, subnet mask, and VLAN membership of the switch interface (sc0 or me1) is correct (use the **show interface** command).
 - Step 5** To prevent conflicts, make sure the me1 and sc0 interfaces are configured with IP addresses and subnet masks in different subnets (use the **show interface** command to check), or disable one of the interfaces using the **set interface {sc0 | me1} disable** command.
 - Step 6** Make sure the host configuration (IP address, subnet mask, default gateway, speed, and duplex setting) is correct.
 - Step 7** If you cannot connect to the switch through the me1 interface, make sure the connected device is configured for half-duplex 10-Mbps operation.
 - Step 8** If the host is in the same subnet as the switch interface, make sure the switch interface and the switch port to which the host is connected are assigned to the same VLAN (use the **show interface** and **show port** commands to check).
 - Step 9** If the host is in a different subnet, make sure the default gateway (default route) on the switch is configured with the address of a router in the same subnet as the switch interface (use the **show ip route** command).
 - Step 10** Check the status of the port connection—should be “connected” (use the **show port** command).
 - Step 11** Check the spanning-tree state on the port (use the **show spantree mod_num/port_num** command)—if the port is in listening or learning mode, wait until the port is in forwarding mode and try to connect to the host again.
 - Step 12** Make sure the speed and duplex settings on the host and the appropriate switch ports are correct (use the **show port** command).

- Step 13** If the connected device is an end station:
- Enable spanning-tree PortFast on the port (use the **set spantree portfast enable** command)—PortFast places the port in forwarding mode immediately, bypassing listening and learning modes (do *not* use this feature for connections to non-end station devices).
 - Disable trunking on the port (use the **set trunk mod_num/port_num off** command).
 - Disable channeling on the port (use the **set port channel port_list off** command)—you must specify a valid port range with this command—you cannot specify a single port.
- Step 14** Make sure the switch is learning the MAC address of the host (use the **show cam dynamic** command).
- Step 15** If possible, try connecting to another port.
-

Cannot autonegotiate the port speed/duplex

Make sure autonegotiation is configured on both ends of the link (use the **show port** command)—you cannot configure settings manually on one end of the link and configure the other end of the link for autonegotiation. If autonegotiation fails when you connect a client NIC to the switch, check the NIC and drivers to make sure that autonegotiation is supported.

If autonegotiation is supported and properly configured but you still cannot connect, turn off autonegotiation and set the speed and duplex manually (use the **set port speed** and **set port duplex** commands).

Contacting the Cisco Technical Assistance Center

If you are unable to solve a startup problem after using the troubleshooting suggestions in this chapter, contact a Cisco TAC representative for assistance and further instructions.

Before you call, have the following information ready to help the Cisco TAC assist you as quickly as possible:

- Date you received the switch
- Chassis serial number
- Type of software and release number
- Maintenance agreement or warranty information
- Brief description of the problem
- Console captures related to your problem
- Brief explanation of the steps you have already taken to isolate and resolve the problem

See the [“Obtain Documentation and Submit a Service Request”](#) section on page 10 for more information about contacting the TAC.



Power Supply Specifications

Revised: March 2013

This appendix describes the power supplies supported by the Catalyst 4500 E-series switches. The appendix contains the following sections:

- [1000 W AC-Input Power Supply, page A-2](#)
- [1300 W AC-Input Power Supply, page A-6](#)
- [1400 W AC-Input Power Supply, page A-10](#)
- [1400 W DC-Input Power Supply, page A-15](#)
- [1400 W Triple-Input DC-Input Power Supply, page A-19](#)
- [2800 W AC-Input Power Supply, page A-25](#)
- [4200 W AC-Input Power Supply, page A-29](#)
- [6000 W AC-Input Power Supply, page A-35](#)
- [9000 W AC-Input Power Supply, page A-43](#)
- [Environmental Monitoring Feature, page A-52](#)
- [Power Redundancy, page A-52](#)

**Tip**

For additional information about the Cisco Catalyst 4500 E-series switches (including configuration examples and troubleshooting information), see the documents listed on this page:

<http://www.cisco.com/en/US/products/hw/switches/ps4324/index.html>

**Note**

All Catalyst 4500 E-series switch AC-input power supplies require single-phase source AC. The source AC can be out of phase between multiple power supplies or multiple AC-power plugs on the same power supply because all AC power supply inputs are isolated. Each chassis power supply should have its own dedicated branch circuit: 15 A or 20 A for North America and circuits sized to local and national codes for International locations.

For more information about power management and planning, see the “Environmental Monitoring and Power Management” chapter in the *Software Configuration Guide* version appropriate for your software.

1000 W AC-Input Power Supply

The 1000 W AC-input power supply (PWR-C45-1000AC), shown in [Figure A-1](#), is supported in the following Catalyst 4500 E-Series switches:

- Catalyst 4503-E
- Catalyst 4506-E
- Catalyst 4507R-E
- Catalyst 4507R+E
- Catalyst 4510R-E (the 1000 W AC-input power supply can be installed in the Catalyst 4510R-E switch chassis; however power management is required)
- Catalyst 4510R+E (the 1000 W AC-input power supply can be installed in the Catalyst 4510R+E switch chassis; however power management is required)

Figure A-1 1000 W AC-Input Power Supply Features

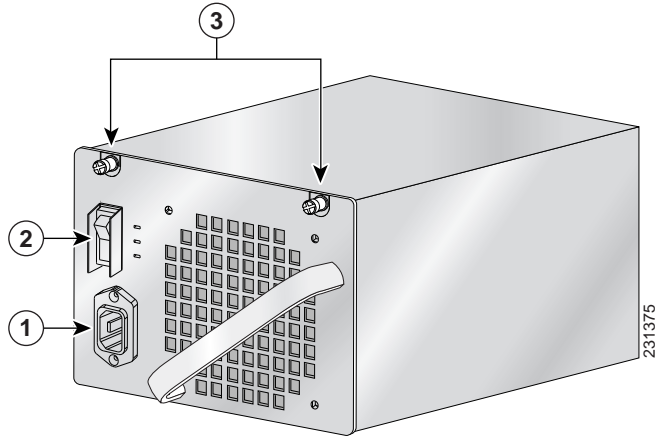

1	AC-input receptacle	3	Captive installation screws
2	Power on/off switch		

1000 W AC-Input Power Supply Specifications

Table A-1 lists the specifications for the 1000 W AC-input power supply.

Table A-1 1000 W AC-Input Power Supply Specifications

Item	Specification
AC-input type	<p>Autoranging input with power factor correction (PFC)</p> <p>Note Power factor correction is a standard feature on all Catalyst 4500 E-series AC-input power supplies. PFC reduces the reactive component in the source AC current allowing higher power factors (typically 99 percent or better) and lower harmonic current components.</p>
AC-input voltage	<ul style="list-style-type: none"> • Low-line (120 VAC nominal)—85 VAC (min) to 132 VAC (max) • High-line (230 VAC nominal)—170 VAC (min) to 264 VAC (max)
AC-input current	<ul style="list-style-type: none"> • 12 A @ 120 VAC • 5 A @ 240 VAC
AC-input frequency	50/60 Hz (nominal) (± 3 Hz for full range)
Branch circuit requirement	<p>Each chassis power supply should have its own dedicated, fused-branch circuit:</p> <ul style="list-style-type: none"> • For North America—15 A or 20 A • For International—Circuits sized to local and national codes • All Catalyst 4500 E-series AC-input power supplies require single-phase source AC. • All AC power supply inputs are fully isolated. <ul style="list-style-type: none"> – Source AC can be out of phase between multiple power supplies in the same chassis, which means that PS1 can be operating from phase A and PS2 can be operating from phase B. – For high-line operation, the power supply operates with the hot conductor wired to a source AC phase and the neutral conductor wired either to ground or to another source AC phase as long as the net input voltage is in the range of 170 to 264 VAC. – Source AC can be out of phase between AC inputs on power supplies that are equipped with multiple AC inputs, which means that power cord 1 can be plugged into phase A and power cord 2 can be plugged into phase B.

Table A-1 1000 W AC-Input Power Supply Specifications (continued)

Item	Specification
Power supply output capacity	1050 W plus 40 W (fan)
Power supply output	83.4 A @ +12 VDC 12.2 A @ +3.3 VDC
Output holdup time	20 ms minimum
Maximum kVA rating	1.32 kVA
Max heat dissipation	943 BTUs/hr
Minimum software requirement	Cisco IOS Release 12.1(12c)EW
Power over Ethernet	Not supported ¹

1. A Catalyst 4503 with a Catalyst 4500 series Supervisor Engine II-Plus TS and a 1000 W power supply will be able to provide 158.4 W of Power over Ethernet (PoE) to ports on the supervisor engine. Switching modules in the other slots will not be able to provide PoE.

Table A-2 lists the 1000 W AC-input power supply LEDs and their meanings.

Table A-2 1000 W AC-Input Power Supply LEDs

LED	Meaning
INPUT OK	<ul style="list-style-type: none"> Green—Source AC voltage is OK. (Input voltage is 85 VAC or greater.) Off—Source AC voltage falls below 70 VAC, is not present, or the power supply is turned off.
FAN OK	<ul style="list-style-type: none"> Green—Power supply fan is operating properly. Off—Power supply fan failure is detected.
OUTPUT FAIL	<ul style="list-style-type: none"> Red—Problem with one or more of the DC-output voltages of the power supply is detected. Off—DC-output voltage with acceptable margins.

1000 W Power Supply AC Power Cords

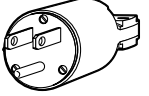
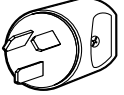
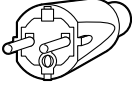

Table A-3 lists the specifications for the regional AC power cords that are available for the 1000 W AC-input power supply.



Note

All 1000 W power supply AC power cords have an IEC60320/C15 appliance plug at one end.

Table A-3 1000 W AC Power Supply Power Cords

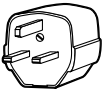
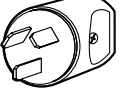
Locale	Power Cord Part Number	Length	Cordset Rating	Plug Type
Japan, North America	CAB-US515-C15-US= (was CAB-7KAC=)	8.2 ft (2.5 m)	15 A, 125 VAC	NEMA 5-15P  120354
Australia, New Zealand	CAB-AS3112-C15-AU= (was CAB-7ACA=)	8.2 ft (2.5 m)	15 A, 250 VAC	AS/NZS 3112-1993  120356
Europe (except Italy)	CAB-CEE77-C15-EU= (was CAB-7ACE=)	8.2 ft (2.5 m)	16 A, 250 VAC	CEE 7/7  120357
Italy	CAB-C2316-C15-IT= (was CAB-7ACI=)	8.2 ft (2.5 m)	16 A, 250 VAC	1/3/16 CEI 23-16  120358
United Kingdom	CAB-BS1363-C15-UK= (was CAB-7ACU=)	8.2 ft (2.5 m)	13 A, 250 VAC	BS 1363/A ¹  120359
Argentina	CAB-IR2073-C15-AR= (was CAB-7KACR=)	8.2 ft (2.5 m)	10 A, 250 VAC	IRAM 2073  120356

1. Plug contains a 13 A fuse.

1300 W AC-Input Power Supply

The 1300 W AC-input power supply (PWR-C45-1300ACV), shown in [Figure A-2](#), is supported in the following Catalyst 4500 E-series switches:

- Catalyst 4503-E
- Catalyst 4506-E
- Catalyst 4507R-E
- Catalyst 4507R+E
- Catalyst 4510R-E (the 1300 W AC-input power supply can be installed in the Catalyst 4510R-E switch chassis; however power management is required)
- Catalyst 4510R+E (the 1300 W AC-input power supply can be installed in the Catalyst 4510R+E switch chassis; however power management is required)

Figure A-2 1300 W AC-Input Power Supply Features

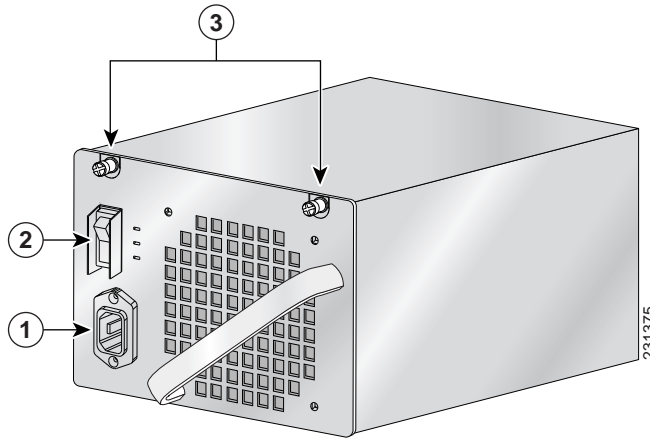

1	AC-input receptacle	3	Captive installation screws
2	Power on/off switch		

1300 W AC-Input Power Supply Specifications

[Table A-4](#) lists the specifications for the 1300 W AC-input power supply.

Table A-4 1300 W AC-Input Power Supply Specifications

Item	Specification
AC-input type	<p>Autoranging input with power factor corrector</p> <p>Note Power factor correction is a standard feature on all Catalyst 4500 E-series AC-input power supplies. PFC reduces the reactive component in the source AC current allowing higher power factors (typically 99 percent or better) and lower harmonic current components.</p>
AC-input voltage	<ul style="list-style-type: none"> • Low-line (120 VAC nominal)—85 VAC (min) to 132 VAC (max) • High-line (230 VAC nominal)—170 VAC (min) to 264 VAC (max)
AC-input current	<ul style="list-style-type: none"> • 16 A @ 100 VAC • 7 A @ 240 VAC
AC-input frequency	50/60 Hz (nominal) (± 3 Hz for full range)
Branch circuit requirement	<p>Each chassis power supply should have its own dedicated, fused-branch circuit:</p> <ul style="list-style-type: none"> • For North America—15 A or 20 A • For International—Circuits sized to local and national codes • All Catalyst 4500 E-series AC-input power supplies require single-phase source AC. • All AC power supply inputs are fully isolated. <ul style="list-style-type: none"> – Source AC can be out of phase between multiple power supplies in the same chassis, which means that PS1 can be operating from phase A and PS2 can be operating from phase B. – For high-line operation, the power supply operates with the hot conductor wired to a source AC phase and the neutral conductor wired either to ground or to another source AC phase as long as the net input voltage is in the range of 170 to 264 VAC. – Source AC can be out of phase between AC inputs on power supplies that are equipped with multiple AC inputs, which means that power cord 1 can be plugged into phase A and power cord 2 can be plugged into phase B.
Power supply output capacity	<ul style="list-style-type: none"> • 1300 W maximum • 1050 W+ 40 W redundant mode (data) • 1667 W maximum in combined mode (data) • 800 W maximum each in redundant mode (PoE) • 1333 W maximum in combined mode (PoE)

Table A-4 1300 W AC-Input Power Supply Specifications (continued)

Item	Specification
Power supply output	<ul style="list-style-type: none"> 84.7 A @ 12 V @ (data) 12.5 A @ 3.3 V (data) 16.7 A @ -50 V (PoE)
Output holdup time	20 ms minimum
Maximum kVA rating	1.76 kVA
Max heat dissipation	1568 BTUs/hr
Minimum software requirement	Cisco IOS Release 12.1(12c)EW
Power over Ethernet (PoE)	Supported, up to 800 W (211 Cisco phones in combined mode)

Table A-5 lists the 1300 W AC-input power supply LEDs and their meanings.

Table A-5 1300 W AC-Input Power Supply LEDs

LED	Meaning
INPUT OK	<ul style="list-style-type: none"> Green—Source AC voltage is OK. (Input voltage is 85 VAC or greater.) Off—Source AC voltage falls below 70 VAC, is not present, or the power supply is turned off.
FAN OK	<ul style="list-style-type: none"> Green—Power supply fan is operating properly. Off—Power supply fan failure is detected.
OUTPUT FAIL	<ul style="list-style-type: none"> Red—Problem with one or more of the DC-output voltages of the power supply is detected. Off—DC-output voltage with acceptable margins. <p>Note For proper operation of the OUTPUT FAIL LED, systems with single power supplies must be configured with a minimum of one fan tray assembly and one supervisor engine. Systems with dual power supplies must have a minimum configuration of one fan tray assembly, one supervisor engine, and one additional module. Failure to meet these minimum configuration requirements can cause a false power supply output fail signal.</p>

1300 W Power Supply AC Power Cords

Table A-6 lists the specifications for the AC power cords that are available for the 1300 W AC-input power supply. The table includes a power plug illustration for each power cord.



Note

All 1300 W power supply power cords have an IEC60320/C19 appliance plug at one end.

Table A-6 1300 W AC-Input Power Supply Power Cords





Locale	Power Cord Part Number	Length	Cordset Rating	AC Source Plug Type
Japan, North America	CAB-US520-C19-US= (was CAB-7513AC=)	14 ft (4.3 m)	20 A, 125 VAC	NEMA 5-20  120362
Australia, New Zealand	CAB-A3112-C19-AUS= (was CAB-7513ACA=)	14 ft (4.3 m)	15 A, 250 VAC	SAA/3, AS/NZS 3112-1993  120356
Europe (except Italy)	CAB-CEE77-C19-EU= (was CAB-7513ACE=)	14 ft (4.3 m)	16 A, 250 VAC	CEE 7/7  120357
Italy	CAB-C2316-C19-IT= (was CAB-7513ACI=)	14 ft (4.3 m)	16 A, 250 VAC	1/3/16, CEI 23-16  120358
United Kingdom	CAB-BS1363-C19-UK= (was CAB-7513ACU=)	14 ft (4.3 m)	13 A, 250 VAC	BS 89/13 BS 1363/A  120359
Argentina	CAB-IR2073-C19-AR= (was CAB-7513ACR=)	14 ft (4.3 m)	16 A, 250 VAC	IRAM 2073  120356
Japan, North America (locking) 200–240 VAC operation	CAB-AC-2800W-TWLK=	13.6 ft (4.1 m)	16 A, 250 VAC	NEMA L6-20  120361

Table A-6 1300 W AC-Input Power Supply Power Cords (continued)

Locale	Power Cord Part Number	Length	Cordset Rating	AC Source Plug Type
Japan, North America (nonlocking) 200–240 VAC operation	CAB-AC-2800W-6-20=	13.2 ft (4.0 m)	16 A, 250 VAC	NEMA 6-20 non-locking  120355
Europe	CAB-AC-2800W-EU=	13.2 ft (4.0 m)	16 A, 250 VAC	CEE 7/7  120357
South Africa, India	CAB-BS546-C15-SA= (was CAB-7513ACSA)	13.6 ft (4.1 m)	16 A, 250 VAC	BS 456  203795
International	CAB-AC-2800W-INT=	13.6 ft (4.1 m)	16 A, 250 VAC	IEC 309  120360
Israeli	CAB-S132-C19-ISRL	14 ft (4.3 m)	16 A, 250 VAC	SI32  130922
UPS 220V	CAB-C19-CBN	9 ft (2.74 m)	20 A, 250 VAC	IEC-60320-C20  130923

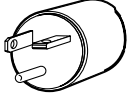
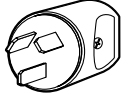
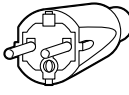
1400 W AC-Input Power Supply

The 1400 W AC-input power supply (PWR-C45-1400AC), shown in [Figure A-3](#), is supported in the following Catalyst 4500 E-series switches:

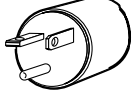
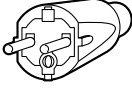
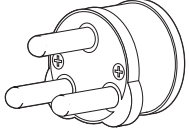
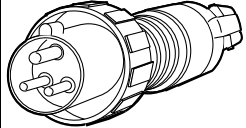
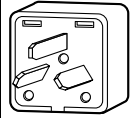
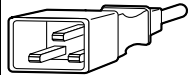
- Catalyst 4503-E
- Catalyst 4506-E
- Catalyst 4507R-E
- Catalyst 4507R+E
- Catalyst 4510R-E
- Catalyst 4510R+E

Figure A-3 1400 W AC-Input Power Supply Features

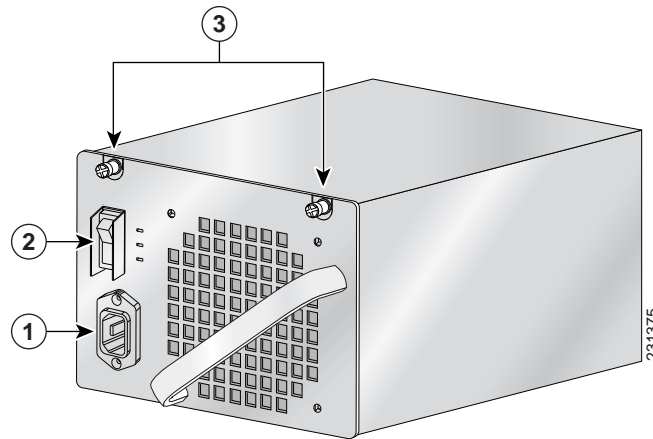

1	AC-input receptacle	3	Captive installation screws
2	Power on/off switch		

1400 W AC-Input Power Supply Specifications

Table A-7 lists the specifications for the 1400 W AC-input power supply.

Table A-7 1400 W AC-Input Power Supply Specifications

Item	Specification
AC-input type	Autoranging input with power factor corrector Note Power factor correction is a standard feature on all Catalyst 4500 E-series AC-input power supplies. PFC reduces the reactive component in the source AC current allowing higher power factors (typically 99 percent or better) and lower harmonic current components.
AC-input voltage	<ul style="list-style-type: none"> Low-line (120 VAC nominal)—85 VAC (min) to 132 VAC (max) High-line (230 VAC nominal)—170 VAC (min) to 264 VAC (max)
AC-input current	<ul style="list-style-type: none"> 16 A @ 120 VAC 7 A @ 240 VAC
AC-input frequency	50/60 Hz (nominal) (± 3 Hz for full range)

Table A-7 1400 W AC-Input Power Supply Specifications (continued)

Item	Specification
Branch circuit requirement	<p>Each chassis power supply should have its own dedicated, fused-branch circuit:</p> <ul style="list-style-type: none"> • For North America—15 A or 20 A • For International—Circuits sized to local and national codes • All Catalyst 4500 E-series AC-input power supplies require single-phase source AC. • All AC power supply inputs are fully isolated. <ul style="list-style-type: none"> – Source AC can be out of phase between multiple power supplies in the same chassis, which means that PS1 can be operating from phase A and PS2 can be operating from phase B. – For high-line operation, the power supply operates with the hot conductor wired to a source AC phase and the neutral conductor wired either to ground or to another source AC phase as long as the net input voltage is in the range of 170 to 264 VAC. – Source AC can be out of phase between AC inputs on power supplies that are equipped with multiple AC inputs, which means that power cord 1 can be plugged into phase A and power cord 2 can be plugged into phase B.
Power supply output	<p>2473 W maximum</p> <p>1360 W + 40 W redundant mode (data)</p>
Power supply output (AC supply)	<p>113.4 A @ +12 V</p> <p>12.2 A @ +3.3 V (data)</p>
Output holdup time	20 ms minimum
Max heat dissipation	1048 BTUs/hr
Maximum kVA rating	1.76 kVA
Minimum software requirement	Cisco IOS Release 12.2(18)EW
Power over Ethernet	Not supported ¹

1. A Catalyst 4503-E with a Catalyst 4500 E-series Supervisor Engine II-Plus TS and a 1400W AC power supply provides 158.4 W of PoE to ports on the supervisor engine. Switching modules in other slots will not be able to provide PoE.

Table A-8 list the 1400 W AC-input power supply LEDs and their meanings.

Table A-8 1400 W AC-Input Power Supply LEDs

LED	Meaning
INPUT OK	<ul style="list-style-type: none"> Green—Source AC voltage is OK. (Input voltage is 85 VAC or greater.) Off—Source AC voltage falls below 70 VAC, is not present, or the power supply is turned off.
FAN OK	<ul style="list-style-type: none"> Green—Power supply fan is operating properly. Off—Power supply fan failure is detected.
OUTPUT FAIL	<ul style="list-style-type: none"> Red—Problem with one or more of the DC-output voltages of the power supply is detected. Off—DC-output voltage with acceptable margins. <p>Note For proper operation of the OUTPUT FAIL LED, systems with single power supplies must be configured with a minimum of one fan tray assembly and one supervisor engine. Systems with dual power supplies must have a minimum configuration of one fan tray assembly, one supervisor engine, and one additional module. Failure to meet these minimum configuration requirements can cause a false power supply output fail signal.</p>

1400 W Power Supply AC Power Cords

Table A-9 lists the specifications for the AC power cords that are available for the 1400 W AC-input power supply. The table includes a power plug illustration for each power cord.



Note

All 1400 W power supply power cords have an IEC60320/C19 appliance plug at one end.

Table A-9 1400 W AC-Input Power Supply Power Cords

Locale	Power Cord Part Number	Length	Cordset Rating	AC Source Plug Type
Japan, North America	CAB-US520-C19-US= (was CAB-7513AC=)	14 ft (4.3 m)	20 A, 125 VAC	NEMA 5-20  120362
Australia, New Zealand	CAB-A3112-C19-AUS= (was CAB-7513ACA=)	14 ft (4.3 m)	15 A, 250 VAC	SAA/3, AS/NZS 3112-1993  120356

Table A-9 1400 W AC-Input Power Supply Power Cords (continued)



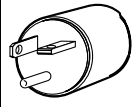
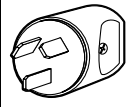

Locale	Power Cord Part Number	Length	Cordset Rating	AC Source Plug Type
Europe (except Italy)	CAB-CEE77-C19-EU= (was CAB-7513ACE=)	14 ft (4.3 m)	16 A, 250 VAC	CEE 7/7  120357
Italy	CAB-C2316-C19-IT= (was CAB-7513ACI=)	14 ft (4.3 m)	16 A, 250 VAC	1/3/16, CEI 23-16  120358
United Kingdom	CAB-BS1363-C19-UK= (was CAB-7513ACU=)	14 ft (4.3 m)	13 A, 250 VAC	BS 89/13 BS 1363/A  120359
Argentina	CAB-IR2073-C19-AR= (was CAB-7513ACR=)	14 ft (4.3 m)	16 A, 250 VAC	IRAM 2073  120356
Japan, North America (locking) 200–240 VAC operation	CAB-AC-2800W-TWLK=	13.6 ft (4.1 m)	16 A, 250 VAC	NEMA L6-20  120361
Japan, North America (nonlocking) 200–240 VAC operation	CAB-AC-2800W-6-20	13.2 ft (4.0 m)	16 A, 250 VAC	NEMA 6-20 non-locking  120355
Europe	CAB-AC-2800W-EU=	13.2 ft (4.0 m)	16 A, 250 VAC	CEE 7/7  120357
South Africa, India	CAB-BS546-C15-SA= (was CAB-7513ACSA)	13.6 ft (4.1 m)	16 A, 250 VAC	BS 456  203795

Table A-9 1400 W AC-Input Power Supply Power Cords (continued)

Locale	Power Cord Part Number	Length	Cordset Rating	AC Source Plug Type
International	CAB-AC-2800W-INT=	13.6 ft (4.1 m)	16 A, 250 VAC	IEC 309 
Israel	CAB-S132-C19-ISRL	14 ft (4.3 m)	16 A, 250 VAC	SI32 
UPS 220 VAC	CAB-C19-CBN	9 ft (2.74 m)	20 A, 250 VAC	IEC-60320-C20 

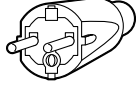
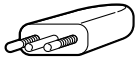
1400 W DC-Input Power Supply

The 1400 W DC-input power supply (PWR-C45-1400DC-P), shown in [Figure A-4](#), is supported in the following Catalyst 4500 E-series switches:

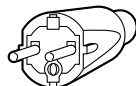
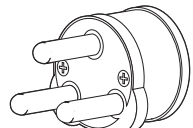
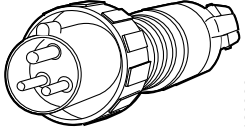
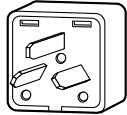
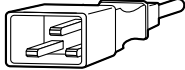
- Catalyst 4503-E
- Catalyst 4506-E
- Catalyst 4507R-E
- Catalyst 4510R-E
- Catalyst 4507R+E
- Catalyst 4510R+E



Caution

Do not install the 1400 W DC power supply with any other power supply under any circumstances. Doing so can seriously damage your switch.

Figure A-4 1400 W DC-Input Power Supply

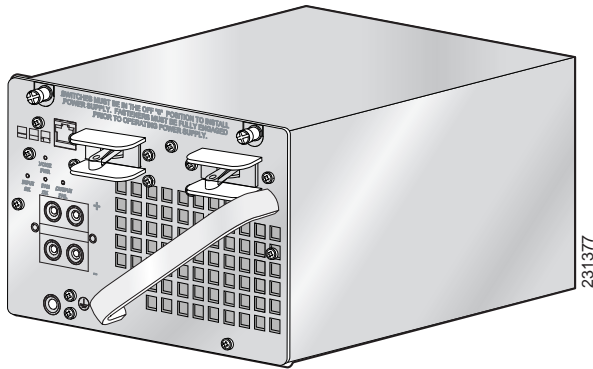

The 1400W DC-input power supply can be used with the Catalyst 4500 Series AC Power Shelf (PWR-P4502-1PSU). Documentation for the Catalyst 4500 Series AC Power Shelf is located at this url:

http://www.cisco.com/en/US/docs/switches/lan/catalyst4500/hardware/configuration/notes/78_15068.html

1400 W DC-Input Power Supply Specifications

Table A-10 lists the specifications for the 1400 W DC-input power supply.

Table A-10 1400 W DC-Input Power Supply Specifications

Item	Specification
DC-input voltage	–48 to –60 VDC (data only) –48 to –56 VDC (inline devices)
DC-input current	31 A @ –60 VDC (data only) 180 A maximum @ –48 VDC input (data and inline devices) The input power is configurable in the CLI. The Cisco IOS command is power dc input . Configure the switch software to match the requirements of your switch.
Power supply output capacity	<ul style="list-style-type: none"> • Data <ul style="list-style-type: none"> – 12 VDC @ 120 A, – 3.3 VDC @ 10 A – 140 A total maximum (35 A maximum each per 5 channels) @–48 to –60 VDC input (inline devices) • 1367 W+ 40 W redundant mode (data) 2267 W maximum in combined mode (data) • 7500 W maximum each in redundant mode (PoE) 7280 W maximum in combined mode (PoE)
DC-input terminal block	Accepts 10 to 12 AWG size copper wire. The actual size of the wire needed is determined by the installer or the local electrician. Terminal block material is rated at 150°C

Table A-10 1400 W DC-Input Power Supply Specifications (continued)

Item	Specification
Output holdup time	4 ms
Heat dissipation	159 BTUs/hr (data) 2905 BTUs/hr (data and voice)

Table A-11 list the 1400 W DC-input power supply LEDs and their meanings.

Table A-11 1400 W DC-Input Power Supply LEDs

LED	Meaning
INPUT OK	<ul style="list-style-type: none"> Green—Source DC voltage is OK. (Input voltage is –40.5 VDC or greater.) Off—Source DC voltage falls below –33 VDC, is not present, or the power supply is turned off.
FAN OK	<ul style="list-style-type: none"> Green—Power supply fan is operating properly. Off—Power supply fan failure is detected.
OUTPUT FAIL	<ul style="list-style-type: none"> Red—Problem with one or more of the DC-output voltages of the power supply is detected. Off—DC-output voltage with acceptable margins.
In-line PWR	<ul style="list-style-type: none"> Green—48 VDC passthrough output voltage is enabled and is greater than –39 VDC and less than –60 VDC. Off—Indicates any of the following: <ul style="list-style-type: none"> Passthrough breakers are not enabled DC input is less than –40.5 VDC One or more –48 VDC outputs is less than –39 VDC Amber—Passthrough breakers are enabled and input voltage exceeds –60 VDC

Table A-12 lists the chassis specific power usage numbers for the 1400 W DC-input power supply.

Table A-12 Chassis-Specific Power Usage

Chassis	Maximum Draw (W)	Maximum Input (W)	Current	Heat Dissipation (BTUs)
Catalyst 4503 specific power usage (data only)	475	633	<ul style="list-style-type: none"> 15.6 A @ –40.5 VDC (min) 8.8 A @ –72 VDC (max) 	2160
Catalyst 4506 specific power usage (data only)	850	1133	<ul style="list-style-type: none"> 28 A @ –40.5 VDC (min) 15.8 A @ –72 VDC (max) 	3515
Catalyst 4507R-E specific power usage (data only)	1080	1440	<ul style="list-style-type: none"> 35.6 A @ –40.5 VDC (min) 20 A @ –72 VDC (max) 	4910

1400 W Triple-Input DC-Input Power Supply

The 1400 W triple-input DC-input power supply (PWR-C45-1400DC), shown in [Figure A-5](#), is supported in the following Catalyst 4500 E-series switches.

- Catalyst 4503-E
- Catalyst 4506-E
- Catalyst 4507R-E
- Catalyst 4510R-E
- Catalyst 4507R+E
- Catalyst 4510R+E

Figure A-5 1400 W Triple-Input DC-Input Power Supply

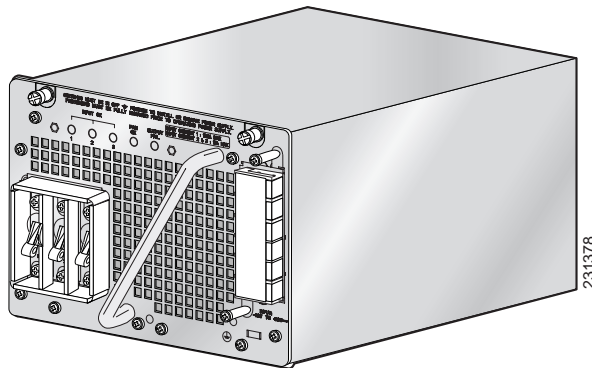

1400 W Triple Input DC-Input Power Supply Specifications

[Table A-13](#) lists the specifications for the 1400 W triple input DC-input power supply.

Table A-13 1400 W DC Triple-Input Power Supply Specifications

Item	Specification
DC-input voltage	<ul style="list-style-type: none"> • -48 VDC for nominal -48 V battery backup system (operating range: -40.5 VDC to -56 VDC) • -60 VDC for nominal -60 V battery backup system (operating range: -55 VDC to -72 VDC)
DC-input current	<ul style="list-style-type: none"> • 42.5 A maximum @ -48 VDC input • Input 1—12.5 A @ -48 to -60 VDC • Input 2—15 A @ -48 to -60 VDC • Input 3—15 A @ -48 to -60 VDC
Power supply output capacity	<ul style="list-style-type: none"> • 1721 W—42.5 A @ -40.5 VDC (min voltage) • 1800 W—25 A @ -72 VDC (max voltage)

Table A-13 1400 W DC Triple-Input Power Supply Specifications (continued)

Item	Specification
Power supply output	<ul style="list-style-type: none"> 8 A (min) to 115.3 A (max) @ +12 VDC 1.2 A (min) to 12.5 A (max) @ +3.3 VDC 1360 W+ 40 W redundant mode 2450 W maximum in combined mode
DC input terminal block	Accepts 10 to 12 AWG size copper wire. The actual size of the wire needed is determined by the installer or the local electrician. Terminal block material is rated at 302°F (150°C)
Output holdup time	8 ms
Maximum kVA rating ¹	1.77 kVA (1400 W load)
Max heat dissipation	1269 BTUs/hr
Minimum software requirement	Cisco IOS Release 12.2(25)EW
Power over Ethernet	Not supported
Catalyst 4503-E Specific Power Usage (data only)	Two modules minimum required @ -40.5 VDC input One 15 A module minimum required @ -44 VDC input
Maximum draw	475 W
Maximum input	609 W total / # of modules = W per module
Current draw at -40.5 V (min voltage) Current draw at -72 V (max voltage)	15 A total / # of modules = Amperes per module 8.5 A total / # of modules = Amperes per module
Max heat dissipation at 609 W	2078 BTUs
Catalyst 4506-E Specific Power Usage (data only)	Two modules minimum required @ -44 VDC input Three modules minimum required @ -40.5 VDC input
Maximum draw (data only)	850 W
Maximum input	1076 W total / # of modules = W per module
Current draw at -40.5 V (min voltage) Current draw at -72 V (max voltage)	26.6 A total / # of modules = Amperes per module 15 A total / # of modules = Amperes per module
Max heat dissipation at 1076 W	3671 BTUs
Catalyst 4507R-Specific Power Usage (data only)	Three modules minimum required
Maximum draw (data only)	1080 W
Max input is 1080 W	1367 W total / # of modules = W per module

Table A-13 1400 W DC Triple-Input Power Supply Specifications (continued)

Item	Specification
Current draw at –40.5 V (min voltage)	33.75 A total / # of modules = Amperes per module
Current draw at –72 V (max voltage)	19 A total / # of modules = Amperes per module
Max heat dissipation 1367 W	4665 BTUs

- The kVA rating listed for the power supply should be used as the sizing criteria for both UPS outputs as well as standard circuits and transformers to power a switch.

Table A-14 list the 1400 W triple-input DC-input power supply LEDs and their meanings.

Table A-14 1400 W DC Triple-Input DC-Input Power Supply LEDs

LED	Meaning
INPUT OK	<ul style="list-style-type: none"> Green—Source DC voltage is OK. (Input voltage is –40.5 VDC or greater.) Off—Source AC voltage falls below –33 VDC, is not present, or the power supply is turned off.
FAN OK	<ul style="list-style-type: none"> Green—Power supply fan is operating properly. Off—Power supply fan failure is detected.
OUTPUT FAIL	<ul style="list-style-type: none"> Red—Problem with one or more of the DC-output voltages of the power supply is detected. Off—DC-output voltage with acceptable margins. <p>Note For proper operation of the OUTPUT FAIL LED, systems with single power supplies must be configured with a minimum of one fan tray assembly and one supervisor engine. Systems with dual power supplies must have a minimum configuration of one fan tray assembly, one supervisor engine, and one additional module. Failure to meet these minimum configuration requirements can cause a false power supply output fail signal.</p>

Table A-15 lists the 1400 W triple-input DC-input power supply input modes and outputs.

Table A-15 1400 W DC Triple-Input Power Supply Input Modes and Output

Input Mode	Source DC Connections	Input Configuration	Maximum Total Output Power
1	1	1 x 12.5 A	386 W @ –40.5 VDC 412 W @ –44.0 VDC
2	2 or 3	1 x 15 A	466 W @ –40.5 VDC 495 W @ –44.0 VDC
3	1, 2 or 3	1 x 12.5 A and 1 x 15 A	845 W @ –40.5 VDC 908 W @ –44.0 VDC

Table A-15 1400 W DC Triple-Input Power Supply Input Modes and Output (continued)

Input Mode	Source DC Connections	Input Configuration	Maximum Total Output Power
4	2, 3	2 x 15 A	914 W @ -40.5 VDC 990 W @ -44.0 VDC
5	1, 2, 3	1 x 12.5 A and 2 x 15 A	1294 W @ -40.5 VDC 1400 W @ -44.0 VDC

Power output also depends on whether two supplies are used, and whether they are in redundant or combined mode. [Table A-16](#) provides a matrix of possible outputs in combined mode depending on the power provided to the supply.

Table A-16 Maximum Power with Two 1400 W DC Triple-Input Power Supplies in Combined Mode

	PS2 input 1	PS2 input 2 or 3	PS2 input 1 and (2 or 3)	PS2 input 2 and 3	PS2 input 1 and 2 and 3
PS1 input 1	824 W	907 W	1320 W	1400 W	1700 W
PS1 input 2 or 3	907 W	990 W	1400 W	1450 W	1750 W
PS1 input 1 and (2 or 3)	1320 W	1400 W	1700 W	1750 W	1900 W
PS1 input 2 and 3	1400 W	1450 W	1750 W	1820 W	2130 W
PS1 input 1 and 2 and 3	1700 W	1750 W	1900 W	2130 W	2450 W

1400 W DC Triple-Input Power Supply Operational Modes

The 1400 W triple-input DC-input power supply (data only) allows added redundancy by providing terminals for two DC inputs rated at 15 A and one rated at 12.5 A per power supply.

This power supply has five operational modes depending on the inputs receiving power. When all three inputs are active, at input voltages greater than -44.0 V DC, the power supply delivers 1400 W maximum total output. [Table A-17](#) provides output information for these modes, given a single supply.

Table A-17 Input Modes

Input Mode	Input Number	Input Configuration	Maximum Total Output Power
1	1	1 x 12.5 A	386 W @ -40.5 VDC 412 W @ -44.0 VDC
2	2 OR 3	1 x 15 A	466 W @ -40.5 VDC 495 W @ -44.0 VDC
3	1, 2 OR 3	1 x 12.5 A and 1 x 15 A	845 W @ -40.5 VDC 908 W @ -44.0 VDC
4	2, 3	2 x 15A	914 W @ -40.5 VDC 990 W @ -44.0 V DC
5	1, 2, 3	1 x 12.5A and 2 x 15 A	1294 W @ -40.5 VDC 1400 W @ -44.0 VDC

The maximum total input current is 42.5 A and the maximum ambient temperature is 55 C. To determine the total maximum input power to a supply, add up the active individual module input power ratings. [Table A-18](#) provides output information for these modes, given two supplies working in combined mode. [Table A-19](#) provides output information for these modes, given two supplies working in redundant mode.

*Table A-18 Combined Mode Power Supply Configuration
(2450 W Max Output Power)*

Input Number	Maximum Input Current	Maximum Input Power @ -44 VDC
1	12.5 A @ -44 VDC	550 W
2	15 A @ -44 VDC	660 W
3	15 A @ -44 VDC	660 W

**Table A-19 Dual Redundant Mode Power Supply Configuration
(1400 W Max Output Power)**

Input Number	Approximate Input Current	Approximate Input Power @ -40.5 VDC	Approximate Input Power @ -44 VDC
1	6.25 A @ -40.5 / -44 VDC	253 W	275 W
2	7.5 A @ -40.5 / -44 VDC	304 W	330 W
3	7.5 A @ -40.5 / -44 VDC	304 W	330 W

**Note**

In a redundant configuration with all inputs supplied, there must be a 100 W minimum system load or the OUTPUT FAIL LED shows a false failure.

The 1400 W triple-input DC-input power supply requires a minimum draw from the system that it is installed in. [Table A-20](#) shows the minimum draw for the possible modes.

Table A-20 Minimum Load Table

	PSU1			PSU2			12 VDC Minimum Load	3.3 VDC Minimum Load
	Input 1	Input 2	Input 3	Input 1	Input 2	Input 3		
Single Operation								
Mode 1	ON	OFF	OFF	—	—	—	1.33 A	0.6 A
Mode 2	OFF	ON	OFF	—	—	—	1.33 A	0.6 A
	OFF	OFF	ON	—	—	—	1.33 A	0.6 A
Mode 3	ON	ON	OFF	—	—	—	2.66 A	0.6 A
	ON	OFF	ON	—	—	—	2.66 A	0.6 A
Mode 4	OFF	ON	ON	—	—	—	2.66 A	0.6 A
Mode 5	ON	ON	ON	—	—	—	4 A	0.6 A
Dual Redundant Operation								
Mode 1	ON	OFF	OFF	ON	OFF	OFF	2.66 A	1.2 A
Mode 2	OFF	ON	OFF	OFF	ON	OFF	2.66 A	1.2 A
	OFF	OFF	ON	OFF	OFF	ON	2.66 A	1.2 A
Mode 3	ON	ON	OFF	ON	ON	OFF	5.32 A	1.2 A
	ON	OFF	ON	ON	OFF	ON	5.32 A	1.2 A
Mode 4	OFF	ON	ON	OFF	ON	ON	5.32 A	1.2 A
Mode 5	ON	ON	ON	ON	ON	ON	8 A	1.2 A

2800 W AC-Input Power Supply

The 2800 W AC-input power supply (PWR-C45-2800ACV), shown in [Figure A-3](#), is supported in the following Catalyst 4500 E-series switches:

- Catalyst 4503-E
- Catalyst 4506-E
- Catalyst 4507R-E
- Catalyst 4510R-E
- Catalyst 4507R+E
- Catalyst 4510R+E

Figure A-6 2800 W AC-Input Power Supply

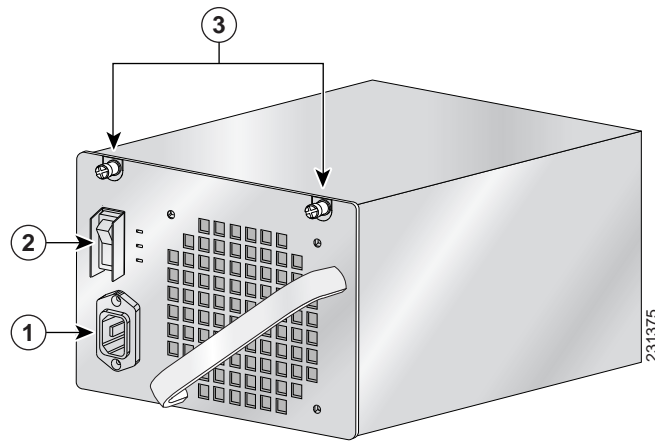

1	AC-in receptacle	3	Captive installation screws
2	On/off power switch		

2800 W AC-Input Power Supply Specifications

[Table A-21](#) lists the specifications for the 2800 W AC-input power supply.

Table A-21 2800 W AC-Input Power Supply Specifications

Item	Specification
AC-input type	Autoranging input with power factor corrector
AC-input voltage	200 to 240 VAC ($\pm 10\%$ for full range)
AC-input current	16 A maximum at 200 VAC
AC-input frequency	50/60 Hz (nominal) ($\pm 3\%$ for full range)

Table A-21 2800 W AC-Input Power Supply Specifications (continued)

Item	Specification
Branch circuit requirement	<p>Each chassis power supply should have its own dedicated, fused-branch circuit:</p> <ul style="list-style-type: none"> • For North America—15 A or 20 A • For International—Circuits sized to local and national codes • All Catalyst 4500 E-series AC-input power supplies require single-phase source AC. • All AC power supply inputs are fully isolated. <ul style="list-style-type: none"> – Source AC can be out of phase between multiple power supplies in the same chassis, which means that PS1 can be operating from phase A and PS2 can be operating from phase B. – For high-line operation, the power supply operates with the hot conductor wired to a source AC phase and the neutral conductor wired either to ground or to another source AC phase as long as the net input voltage is in the range of 170 to 264 VAC. – Source AC can be out of phase between AC inputs on power supplies that are equipped with multiple AC inputs, which means that power cord 1 can be plugged into phase A and power cord 2 can be plugged into phase B.
Power supply output capacity	<p>2800 W maximum</p> <p>1360 W+ 40 W redundant mode (data)</p> <p>2473 W maximum in combined mode (data)</p> <p>1400 W maximum each in redundant mode (PoE)</p> <p>2333 W maximum in combined mode (PoE)</p>
Power supply output	<ul style="list-style-type: none"> • 113.3 A @ 12 VDC (data) • 12.1 A @ 3.3 VDC (data) • 28 A @ -50 VDC (PoE)
Output holdup time	20 ms minimum
Maximum kVA rating	3.52 kVA
Max heat dissipation	2387 BTUs/hr.
Minimum software requirement	Cisco IOS Release 12.1(13)EW
Power over Ethernet	Supported, up to 1400 W (240 Cisco phones in combined mode)

Table A-22 describes the 2800 W AC-input power supply LEDs and their meanings.

Table A-22 2800 W AC-Input Power Supply LEDs

LED	Color/State	Description
INPUT OK	Green	Indicates whether the input voltage is within the required range: Input voltage is within the required range.
	Flashing	Input voltage is present, but is below required range.
	Off	Input voltage is below the required range or the power supply is off.
OUTPUT FAIL	Red	Output voltage is not within the specified range.
	Off	Output voltage is within the specified range.
FAN OK	Green	Indicates the status of the power supply fans: The fans are operational.
	Off	The fans are not operational.

2800 W Power Supply AC Power Cords

Table A-23 lists the specifications for the AC power cords that are available for the 2800 W AC-input power supply.



Note

All 2800 W AC-input power supply power cords have an IEC60320/C19 appliance plug at one end.

Table A-23 2800 W AC-Input Power Supply Power Cords

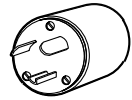
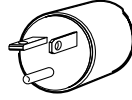
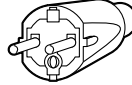
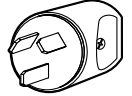
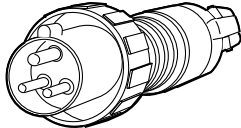
Locale	Power Cord Part Number	Length	Cordset Rating	AC Source Plug Type
Japan, North America (locking) 200–240 VAC operation	CAB-AC-2800W-TWLK=	13.6 ft (4.1 m)	16 A, 250 VAC	NEMA L6-20  120361
Japan, North America (nonlocking) 200–240 VAC operation	CAB-AC-2800W-6-20	13.2 ft (4.0 m)	16 A, 250 VAC	NEMA 6-20 non-locking  120355
Europe	CAB-AC-2800W-EU=	13.2 ft (4.0 m)	16 A, 250 VAC	CEE 7/7  120357
Argentina	CAB-IR2073-C19-AR= (was CAB-7513ACR=)	14 ft (4.3 m)	16 A, 250 VAC	IRAM 2073  120356
International	CAB-AC-2800W-INT=	13.6 ft (4.1 m)	16 A, 250 VAC	IEC 309  120360

4200 W AC-Input Power Supply

The 4200 W AC-input power supply (PWR-C45-4200ACV), shown [Figure A-7](#), is supported in the following Catalyst 4500 E-series switches:

- Catalyst 4503-E
- Catalyst 4506-E
- Catalyst 4507R-E
- Catalyst 4510R-E
- Catalyst 4507R+E
- Catalyst 4510R+E

Figure A-7 4200 W AC-Input Power Supply

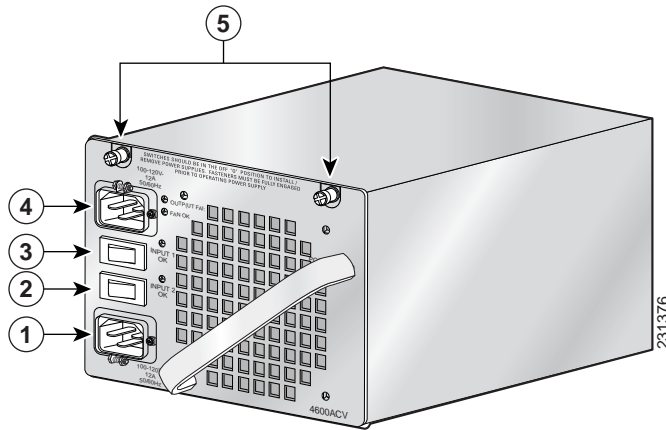

1	AC-input 2 receptacle	4	AC-input 1 receptacle
2	AC-input 2 power on/off switch	5	Captive installation screws
3	AC-input 1 power on/off switch		

4200 W AC-Input Power Supply Specifications

[Table A-24](#) lists the specifications for the 4200 W AC-input power supply.

Table A-24 4200 W AC-Input Power Supply Specifications

Item	Specification
AC-input type	<p data-bbox="675 323 1484 359">Autoranging input with power factor corrector</p> <p data-bbox="675 359 1484 541">Note Power factor correction is a standard feature on all Catalyst 4500 E-series AC-input power supplies. PFC reduces the reactive component in the source AC current allowing higher power factors (typically 99 percent or better) and lower harmonic current components.</p>
AC-input voltage	<ul data-bbox="675 541 1484 632" style="list-style-type: none"> • Low-line (120 VAC nominal)—85 VAC (min) to 132 VAC (max) • High-line (230 VAC nominal)—170 VAC (min) to 264 VAC (max)
AC-input current	12 A (maximum) @ 120 VAC or 230 VAC for each input
AC-input frequency	50/60 Hz (nominal) ($\pm 3\%$ for full range)
Branch circuit requirement	<p data-bbox="675 716 1484 779">Each chassis power supply should have its own dedicated, fused-branch circuit:</p> <ul data-bbox="675 779 1484 1392" style="list-style-type: none"> • For North America—15 A or 20 A • For International—Circuits sized to local and national codes • All Catalyst 4500 E-series AC-input power supplies require single-phase source AC. • All AC power supply inputs are fully isolated. <ul data-bbox="740 1010 1484 1392" style="list-style-type: none"> – Source AC can be out of phase between multiple power supplies in the same chassis, which means that PS1 can be operating from phase A and PS2 can be operating from phase B. – For high-line operation, the power supply operates with the hot conductor wired to a source AC phase and the neutral conductor wired either to ground or to another source AC phase as long as the net input voltage is in the range of 170 to 264 VAC. – Source AC can be out of phase between AC inputs on power supplies that are equipped with multiple AC inputs, which means that power cord 1 can be plugged into phase A and power cord 2 can be plugged into phase B.

Table A-24 4200 W AC-Input Power Supply Specifications (continued)

Item	Specification
Power supply output capacity	<p>The power supply output capacity is dependent on the number of AC power cords (1 or 2) attached, the source AC voltage (110 VAC [low-line] or 220 VAC [high-line] applied to the power supply inputs, and the number of power supply power switches switched on or off.</p> <p>Note If source AC is applied to both two inputs, both inputs should have the same AC voltage.</p>
1050 W operation	<p>1050 W maximum with the following combinations of power cords and source AC voltage applied to the power supply inputs:</p> <ul style="list-style-type: none"> • One AC input is connected to low-line (110 VAC nominal); the second AC input is not connected to source AC or is switched off.
2100 W operation	<p>2100 W maximum with the following combinations of power cords and source AC voltage applied to the power supply inputs:</p> <ul style="list-style-type: none"> • Both AC inputs are connected to low-line (110 VAC nominal) and both inputs are switched on. • One AC input connected to high-line (220 VAC nominal); the second AC input is not connected or is switched off.
4200 W operation	<p>4200 W maximum with the following combinations of power cords and source AC voltage applied to the power supply inputs:</p> <ul style="list-style-type: none"> • Both AC inputs are connected to high-line (220 VAC nominal) and both inputs are switched on.
Power supply output	<ul style="list-style-type: none"> • 1050 W operation (with one 110 VAC nominal input) <ul style="list-style-type: none"> – 55.9 A @ 12 V (data only) – 12.5 A @ 3.3 V (data only) – 14.6 A @ –50 V (PoE if used) • 2100 W operation (with two 110 VAC nominal inputs) <ul style="list-style-type: none"> – 115.3 A @ 12 V (data only) – 12.5 A @ 3.3 V (data only) – 38.0 A @ –50 V (PoE if used) • 2100 W operation (with one 220 VAC nominal input) <ul style="list-style-type: none"> – 115.3 A @ 12 V (data only) – 12.5 A @ 3.3 V (data only) – 38.5 A @ –50 V (PoE if used) • 4200 W operation (with two 220 VAC nominal inputs) <ul style="list-style-type: none"> – 115.3 A @ 12 V (data only) – 12.5 A @ 3.3 V (data only) – 77.1 A @ –50 V (PoE if used)
Output holdup time	20 ms minimum
Maximum kVA rating	5.25 kVA

Table A-24 4200 W AC-Input Power Supply Specifications (continued)

Item	Specification
Max heat dissipation	3583 BTUs/hr.
Minimum software requirement	Cisco IOS Release 12.2(25)EWA
Power over Ethernet	Supported, up to 4200 W

[Table A-25](#) describes the 4200 W AC-input power supply LEDs and their meanings.

Table A-25 4200 W AC-Input Power Supply LEDs

LED	Color/State	Description
INPUT OK		Indicates whether the input voltage is within the required range:
	Green	Input voltage is within the required range.
	Flashing	Input voltage is present, but is below required range.
	Off	Input voltage is below the required range or the power supply is off.
OUTPUT FAIL	Red	Output voltage is not within the specified range.
	Off	Output voltage is within the specified range.
FAN OK	Green	Indicates the status of the power supply fans: The fans are operational.
	Off	The fans are not operational.

**Note**

The 4200 W AC power supply should not be used in mixed-voltage configurations. All the inputs in a chassis must be at the same voltage (110 VAC or 220 VAC).

[Table A-26](#) shows the wattage output possible from a 4200 W power supply in redundant mode. In redundant mode, the two power supplies must have the same number of inputs and all inputs must be the same voltage. If the input voltages to the power supplies are mismatched, choose the value matching the weaker of the two power supplies.

Table A-26 Redundant Mode Output

Source AC to Power Supplies	+12 VDC	+3.3 VDC	-50 VDC	Total (W)
110 VAC to one input on supply 1 and one 100 VAC to one input on power supply 2	660 W	40 W	700 W	1050 W
110 VAC to both inputs on power supply 1 and 110 VAC to both inputs on power supply 2, or one 220 VAC input to power supply 1 and one 220 VAC input to power supply 2	1360 W	40 W	1850 W	2100 W
220 VAC to both inputs on power supply 1 and power supply 2	1360 W	40 W	3700 W	4200 W

Table A-27 shows the maximum output wattage with two 4200 W AC-input power supplies operating in combined mode.

Table A-27 4200 W Power Supplies in Combined Mode Output

Source AC to Power Supplies	W @ +12 VDC	W @ +3.3 VDC	W @ -50 VDC	Maximum (W)
Both power supplies with one input at 110 VAC	1200 W	40 W	1320 W	1870 W
One 110 VAC input to one power supply and two 110 VAC inputs to the other power supply	1800 W	40 W	2000 W	2730 W
Both power supplies with two 110 VAC inputs	2200 W	40 W	3100 W	3800 W
Both power supplies with one 220 VAC input	2200 W	40 W	3100 W	3800 W
Two 220 VAC inputs to one power supply, one 220 VAC input to the other power supply	2200 W	40 W	4700 W	5500 W
Both power supplies with two 220 VAC inputs	2200 W	40 W	6200 W	7600 W

4200 W Power Supply AC Power Cords

Table A-28 lists the specifications for the AC power cords that are available for the 4200 W AC-input power supply.



Note

All 4200 W power supply power cords have an IEC60320/C19 appliance plug at one end.

Table A-28 4200 W AC-Input Power Supply Power Cords





Locale	Power Cord Part Number	Length	Cordset Rating	AC Source Plug Type
Japan, North America 120 VAC operation	CAB-US515P-C19-US	9.8 ft (2.98 m)	15 A, 125 VAC	NEMA 5-15P  120354
Japan, North America (locking) 200–240 VAC operation	CAB-L620P-C19-US	14 ft (4.2 m)	20 A, 250 VAC	NEMA L6-20  120361
Japan, North America (nonlocking) 200–240 VAC operation	CAB-US620P-C19-US	13.2 ft (4.02 m)	20 A, 250 VAC	NEMA 6-20 non-locking  120355
Europe	CAB-CEE77-C19-EU	13.2 ft (4.0 m)	15 A, 250 VAC	CEE 7/7  120357
International (including Argentina and South Africa)	CAB-I309-C19-INT	13.6 ft (4.1 m)	16 A, 250 VAC	IEC 309  120360
Australia	CAB-A3112-C19-AUS	14 ft (4.3 m)	15 A, 250 VAC	AS/NZS 3112  120356
Argentina	CAB-IR2073-C19-AR= (was CAB-7513ACR=)	14 ft (4.3 m)	10 A, 250 VAC	IRAM 2073  120356
Italy	CAB-C2316-C19-IT	14 ft (4.3 m)	16 A, 250 VAC	CEI 23-16  120358

Table A-28 4200 W AC-Input Power Supply Power Cords (continued)

Locale	Power Cord Part Number	Length	Cordset Rating	AC Source Plug Type
United Kingdom	CAB-BS1363-C19-UK	14 ft (4.3 m)	13 A, 250 VAC	BS 1363  120359
Israeli	CAB-S132-C19-ISRL	14 ft (4.3 m)	16 A, 250 VAC	SI32  130922
UPS 220V	CAB-C19-CBN	9 ft (2.74 m)	20 A, 250 VAC	IEC-60320-C20  130923

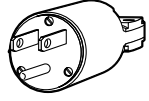
6000 W AC-Input Power Supply

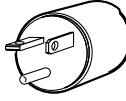
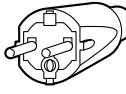
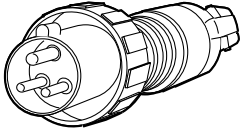
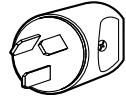
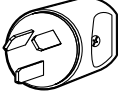
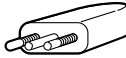
The 6000 W AC-input power supply (PWR-C45-6000ACV), shown in [Figure A-8](#), is supported in following Catalyst 4500 E-series switch chassis:

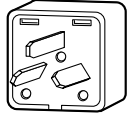
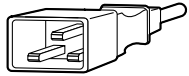
- Catalyst 4503-E
- Catalyst 4506-E
- Catalyst 4507R-E
- Catalyst 4510R-E
- Catalyst 4507R+E
- Catalyst 4510R+E

Figure A-8 6000 W Dual-Input AC Power Supply

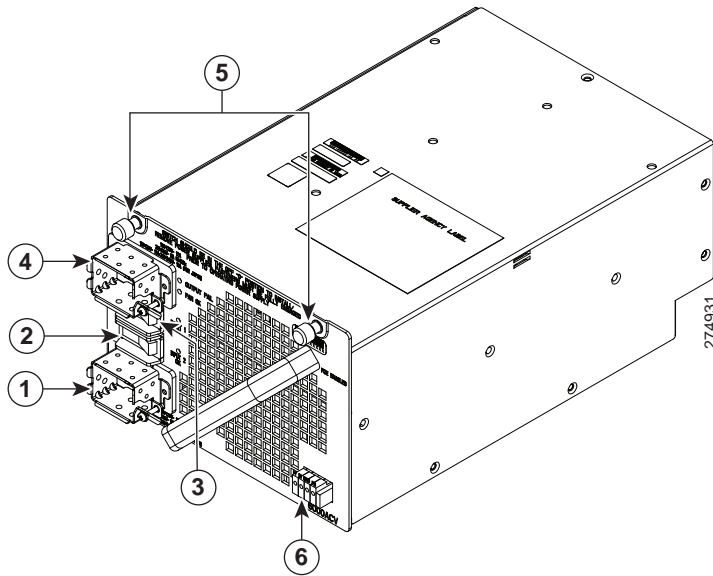

1	AC-input 2 receptacle	4	AC-input 1 receptacle
2	AC-input 2 on switch	5	Captive screws
3	AC-input 1 on switch	6	Remote power cycling terminal

6000 W Power Supply Specifications

Table A-29 lists the specifications for the 6000 W AC-input power supplies.

Table A-29 6000 W AC-Input Power Supply Specifications

Item	Specification
AC-input type	Autoranging inputs with power factor correction Note Power factor correction is a standard feature on all Catalyst 4500 E-series AC-input power supplies. PFC reduces the reactive component in the source AC current allowing higher power factors (typically 99 percent or better) and lower harmonic current components.
AC-input voltage	<ul style="list-style-type: none"> Low-line (120 VAC nominal)—85 VAC (min) to 132 VAC (max) High-line (230 VAC nominal)—170 VAC (min) to 264 VAC (max)
AC-input current	<ul style="list-style-type: none"> 12 A (max) @ 120 VAC (for each input) 16 A (max) @ 230 VAC (for each input)
AC-input frequency	50/60 Hz (nominal) ($\pm 3\%$ for full range)

Table A-29 6000 W AC-Input Power Supply Specifications

Item	Specification
Power supply output	<p>Total output depends on the number of inputs connected and the source AC voltage. If two inputs are used, they should both be of the same AC voltage.</p> <ul style="list-style-type: none"> • 1050 W operation (with one 120 VAC nominal input) <ul style="list-style-type: none"> – 70.8 A @ 12 VDC (data only) – 12.5 A @ 3.3 VDC (data only) – 18.4 A @ –50 VDC (PoE if used) • 2100 W operation (with two 120 VAC nominal inputs) <ul style="list-style-type: none"> – 141.6 A @ 12 VDC (data only) – 12.5 A @ 3.3 VDC (data only) – 37.0 A @ –50 VDC (PoE if used) • 3000 W operation (with one 230 VAC nominal input) <ul style="list-style-type: none"> – 183.3 A @ 12 VDC (data only) – 12.5 A @ 3.3 VDC (data only) – 48 A @ –50 VDC (PoE if used) • 6000 W operation (with two 230 VAC nominal inputs) <ul style="list-style-type: none"> – 183.3 A @ 12 VDC (data only) – 12.5 A @ 3.3 VDC (data only) – 96 A @ –50 VDC (PoE if used)
Power supply output capacity	6000 W maximum
Output holdup time	20 ms minimum
kVA rating ¹	6.8 kVA (power factor = 0.99)
Heat dissipation	2,720 BTUs/hr (approx.)
Minimum software requirement	Cisco IOS Release 12.2(52)SG
Power over Ethernet	Supported, up to 4800 W

1. The kVA rating listed for the power supply should be used as the sizing criteria for both UPS outputs as well as standard circuits and transformers to power a switch.

Table A-30 list the 6000 W AC-input power supply LEDs and their meanings.

Table A-30 6000 W AC-input Power Supply LEDs

LED	Meaning
INPUT OK	<ul style="list-style-type: none"> Green—Source AC voltage is OK. (Input voltage is 85 VAC or greater.) Off—Source AC voltage falls below 70 VAC, is not present, or the power supply is turned off.
FAN OK	<ul style="list-style-type: none"> Green—Power supply fan is operating properly. Off—Power supply fan failure is detected.
OUTPUT FAIL	<ul style="list-style-type: none"> Red—Problem with one or more of the DC-output voltages of the power supply is detected. Off—DC-output voltage with acceptable margins. <p>Note For proper operation of the OUTPUT FAIL LED, systems with single power supplies must be configured with a minimum of one fan tray assembly and one supervisor engine. Systems with dual power supplies must have a minimum configuration of one fan tray assembly, one supervisor engine, and one additional module. Failure to meet these minimum configuration requirements can cause a false power supply output fail signal.</p>

**Note**

The 6000 W AC-input power supply should not be used in mixed-voltage configurations. All the inputs in a chassis must be at the same voltage (110 VAC or 220 VAC).

Table A-31 shows the wattage output possible from a 6000 W AC-input power supply in redundant mode. In redundant mode, two power supplies must have identical inputs and all inputs must be at the same voltage. If the input voltages are mismatched, choose the value matching the weaker of the two power supplies.

Table A-31 Redundant Mode Output

	12 VDC	3.3 VDC	-50 VDC	Total
110 VAC to a single input on both supplies	850 W	40 W	922 W	1050 W
110 VAC to both inputs on both supplies	1700 W	40 W	1850 W	2100 W
220 VAC input to one input on both supplies	2200 W	40 W	2400 W	3000 W
220 VAC to both inputs on both supplies	2200 W	40 W	4600 W	6000 W

Table A-32 shows the maximum output wattage with two 6000 W AC-input power supplies in combined mode.

Table A-32 Combined Mode Output

	W @ 12 VDC	W @3.3 VDC	W @ -50 VDC	Maximum (W)
Both PS with one input at 110 VAC	1400 W	40 W	1670 W	1710 W
One 110 VAC input to one PS, two 110 VAC inputs to the other PS	2360 W	40 W	2560 W	2800 W
Both PS with two 110 VAC inputs	3090 W	40 W	3360 W	3700 W
Both PS with one 220 VAC input	4000 W	40 W	4360 W	5400 W
Two 220 VAC inputs to one PS, one 220 VAC input to the other PS	4000 W	40 W	6600 W	6200 W
Both PS with two 220 VAC inputs	4000 W	40 W	8700 W	10900 W

6000 W Power Supply AC Power Cords

Table A-33 lists the specifications for the AC power cords that are available for the 6000 W AC-input power supply. The table includes references to power cord illustrations.



Note

All 6000 W AC-input power supply power cords have an IEC60320/C19 appliance plug at one end.

Table A-33 6000 W AC-Input Power Supply Power Cords

Locale	Power Cord Part Number	Length	Cordset Rating	AC Source Plug Type
Japan, North America 120 VAC operation	CAB-US515P-C19-US	9.8 ft (2.98 m)	15 A, 125 VAC	NEMA 5-15P  120354
Japan, North America (nonlocking) 200–240 VAC operation	CAB-US620P-C19-US	13.2 ft (4.02 m)	20 A, 250 VAC	NEMA 6-20 non-locking  120355
Europe	CAB-AC-2800W-EU= CAB-CEE77-C19-EU=	13.2 ft (4.0 m)	16 A, 250 VAC	CEE 7/7  120357

Table A-33 6000 W AC-Input Power Supply Power Cords (continued)







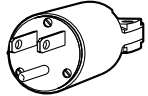
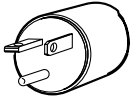
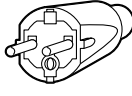

Locale	Power Cord Part Number	Length	Cordset Rating	AC Source Plug Type
International	CAB-AC-2800W-INT= CAB-I309-C19-INT=	13.6 ft (4.1 m)	20 A, 250 VAC	IEC 309  120360
Japan, North America (locking) 200–240 VAC operation	CAB-AC-2800W-TWLK= CAB-L620P-C19-US=	13.6 ft (4.1 m)	16 A, 250 VAC	NEMA L6-20  120361
Australia	CAB-AC-16A-AUS CAB-A3112-C19-AUS=	14 ft (4.3 m)	16 A, 250 VAC	AU20S3  275667
Argentina	CAB-IR2073-C19-AR=	14 ft (4.3 m)	16 A, 250 VAC	IRAM 2073  120356
China 200–240 VAC operation	CAB-9K16A-CH	14 ft (4.3 m)	16 A, 250 VAC	GB16C  275664
Switzerland	CAB-ACS-16	8 ft (2.9 m)	16 A, 250 VAC	G23  275665
India	CAB-SABS-C19-IND	14 ft (4.3 m)	16 A, 250 VAC	SABS 164-1  275666
United Kingdom	CAB-AC-2800W-INT CAB-I309-C19-INT	14 ft (4.3 m)	16 A, 250 VAC	IEC 309  120360

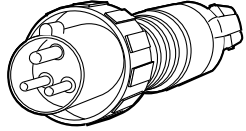
Table A-33 6000 W AC-Input Power Supply Power Cords (continued)

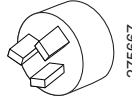
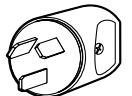
Locale	Power Cord Part Number	Length	Cordset Rating	AC Source Plug Type
Italy	CAB-C2316-C19-IT=	14 ft (4.3 m)	16 A, 250 VAC	CEI 23-16  120358
Israel	CAB-S132-C19-ISRL=	14 ft (4.3 m)	16 A, 250 VAC	SI 16S3  130922
Brazil	CAB-EL224-C19-BR=	8 ft (2.9 m)	16 A, 250 VAC	NBR 14136  275665
UPS 220V	CAB-C19-CBN	9 ft (2.74 m)	20 A, 250 VAC	IEC-60320-C20  130923

Remote Power Cycling Feature

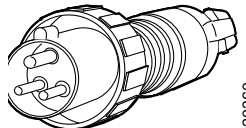
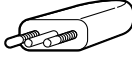
The 6000 W AC-input power supply is equipped with a remote power cycling feature that allows you to remotely turn on or turn off the power supply through an external relay controller box. Figure A-9 shows a typical remote power on/off setup. A three-position terminal block, located on the lower right quadrant of the power supply faceplate, provides the interface to the external relay controller box. (See Figure A-9.)

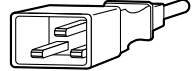
Figure A-9 Remote Power On/Off Feature Components

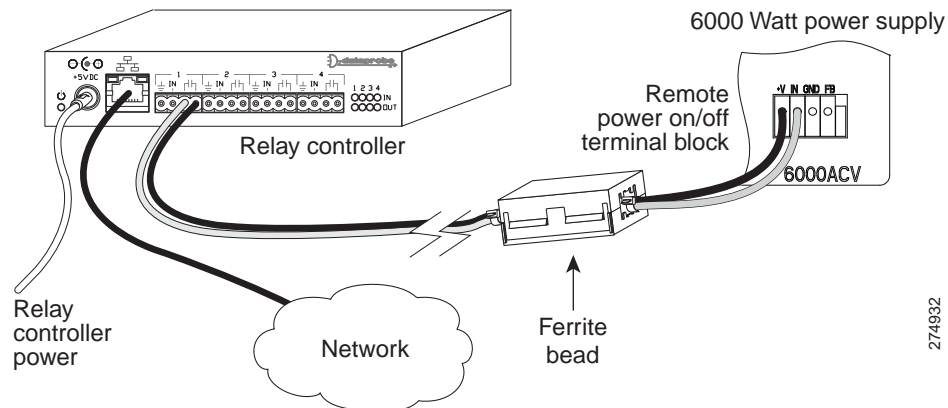

Terminal Block

The terminal block has four contacts labeled +V, IN, GND, and FB. Two control wires from an external relay controller box attach to either +V and IN or IN and GND. +V and IN are used when the relay controller box contains a normally-open (NO) type of relay. IN and GND are used when using an RS-232 interface.

Ferrite Bead

A plastic bag containing one ferrite bead and two 4-inch plastic ties is included with the 6000 W power supply AC power cords. The ferrite bead is a passive device that limits high-frequency interference on interface and control cables and is only required when you install the remote power-cycling feature that is supported by the 6000 W power supply. The ferrite bead is installed on the two control wires that come from the relay controller box to the terminal block on the 6000 W power supply. The ferrite bead should be installed as close as possible to the power supply terminal block for the bead to be effective. You do not need the ferrite bead for 6000 W power supply installations that do not include the remote power-cycling feature.

Remote Power-Cycling Operation

This feature allows you to remotely power cycle the Catalyst 4500 E-series switch using any appropriate third-party relay controller. This feature eliminates the need for you to have access to the supervisor engine console or CLI to control power cycling. [Table A-34](#) lists the relay controller box relay type, the corresponding power supply terminal block positions, and a description of the power-cycling operation.

Table A-34 6000 W Power Supply Relay Controller Switch Settings and Operation

External Relay Controller Box Relay Type	Power Supply Terminal Block Positions Used	Remote Power-Cycling Operation
Normally open (NO) relay.	The +V pin is internally pulled up to 12 VDC with a 10 K ohms pull up resistor, and pin IN is connected to the input pin (either pin 1, 4, 10, or 13) of the line receiver.	<ul style="list-style-type: none"> Power supply cycled from on to off. The power supply is powered off by energizing the relay (relay contacts go from open to closed) for more than 5 seconds. Power supply cycled from off to on. The power supply is powered on by reenergizing the relay (relay contacts go from closed to open) after a 10 second delay.
RS232 driver.	Pin IN is connected to the input pin (either pin 1, 4, 10, or 13) of the line receiver, and pin GND is connected to ground. A capacitor of 1 uF should be used between the line receiver input and the ground to bypass noise peaks.	<ul style="list-style-type: none"> Power supply cycles from on to off. The power supply is powered off by RS-232 logic HI for more than 5 seconds. Power supply cycles from off to on— The power supply is powered on by RS-232 logic LO after a 10 second delay.
No relay attached. Remote power-cycling feature not installed.	—	—

9000 W AC-Input Power Supply

The 9000 W AC-input power supply (PWR-C45-9000ACV), shown in [Figure A-10](#), is supported by the following Catalyst 4500 E-series switch chassis:

- Catalyst 4503-E
- Catalyst 4506-E
- Catalyst 4507R-E
- Catalyst 4510R-E
- Catalyst 4507R+E
- Catalyst 4510R+E

Figure A-10 9000 W AC_Input Power Supply Features

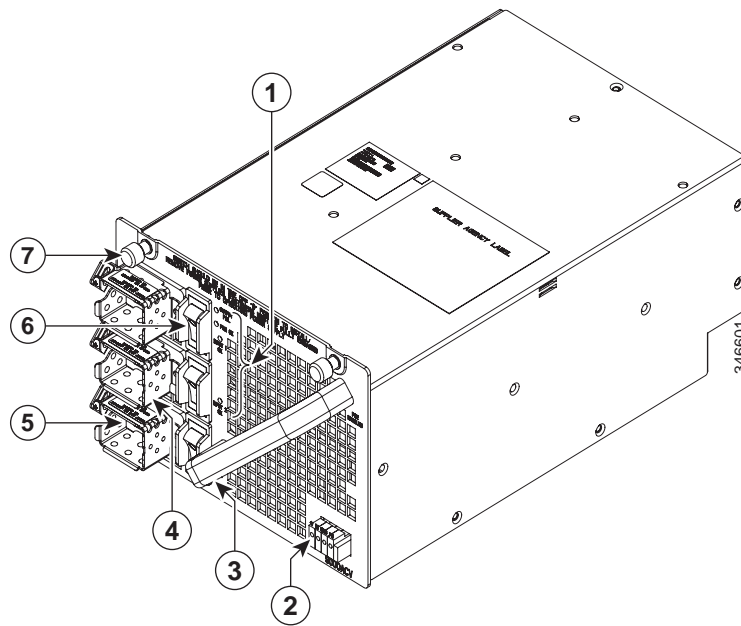

1	Power supply status LEDs	5	AC in connectors (IE60320/C20) (3 inputs)
2	Remote power cycling feature terminal block	6	AC power switches (3 switches)
3	Handle	7	Captive installation screws (2X)
4	Power cord connector retention clips		

9000 W Power Supply Specifications

Table A-35 lists the specifications for the 9000 W AC-input power supply.

Table A-35 9000 W AC-Input Power Supply Specifications

Item	Specification
AC-input type	<p>Autoranging inputs with power factor correction (PFC)</p> <p>Note PFC is a standard feature on all Catalyst 4500 E-series AC-input power supplies. PFC reduces the reactive component in the source AC current allowing higher power factors (typically 99 percent or better) and lower harmonic current components.</p>
AC-input voltage	<ul style="list-style-type: none"> • Low-line (120 VAC nominal)—85 VAC (min) to 132 VAC (max) • High-line (230 VAC nominal)—170 VAC (min) to 264 VAC (max) <p>Note Mixed voltage input mode operation is supported. However, with mixed voltage inputs, output power defaults to the triple 120 VAC output limits.</p>
AC-input current	<ul style="list-style-type: none"> • 12 A (max) @ 120 VAC (for each input) • 16 A (max) @ 230 VAC (for each input)
AC-input frequency	50/60 Hz (nominal) ($\pm 3\%$ for full range)
DC output voltages	<ul style="list-style-type: none"> • 12 VDC (11.8 VDC (min) to 12.2 VDC (max)) • 3.3 VDC (3.2 VDC (min) to 3.4 VDC (max)) • -50 VDC (-48 VDC (min) to -52 VDC (max))

Table A-35 9000 W AC-Input Power Supply Specifications (continued)

Item	Specification
Power supply output	<p>Total output power depends on the number of inputs connected and the available source AC voltage. If more than one input is used, all inputs be the same AC voltage (either high-line or low-line).</p> <p>Note Mixed voltage input mode operation is supported.</p> <ul style="list-style-type: none"> • 1100 W operation (with one 120 VAC nominal input) <ul style="list-style-type: none"> – 80 A @ 12 VDC (data only) – 12.5 A @ 3.3 VDC (data only) – 20 A @ –50 VDC (PoE if used) • 2200 W operation (with two 120 VAC nominal inputs) <ul style="list-style-type: none"> – 121.7 A @ 12 VDC (data only) – 12.5 A @ 3.3 VDC (data only) – 40 A @ –50 VDC (PoE if used) • 3300 W operation (with three 120 VAC nominal inputs) <ul style="list-style-type: none"> – 121.7 A @ 12 VDC (data only) – 12.5 A @ 3.3 VDC (data only) – 50 A @ –50 VDC (PoE if used) • 3000 W operation (with one 230 VAC nominal input) <ul style="list-style-type: none"> – 121.7 A @ 12 VDC (data only) – 12.5 A @ 3.3 VDC (data only) – 50 A @ –50 VDC (PoE if used) • 6000 W operation (with two 230 VAC nominal inputs) <ul style="list-style-type: none"> – 166.7 A @ 12 VDC (data only) – 12.5 A @ 3.3 VDC (data only) – 100 A @ –50 VDC (PoE if used) • 9000 W operation (with three 230 VAC nominal inputs) <ul style="list-style-type: none"> – 166.7 A @ 12 VDC (data only) – 12.5 A @ 3.3 VDC (data only) – 150 A @ –50 VDC (PoE if used)

Table A-35 9000 W AC-Input Power Supply Specifications (continued)

Item	Specification
Power supply output capacity	9000 W maximum
Output holdup time	20 ms minimum
kVA rating ¹	9680 kVA (power factor = 0.99)
Heat dissipation	3010 BTUs/hr (max.)
Minimum software requirement	Cisco IOS Release IOS-XE 3.4.0SG/15.1(2)SG
Power over Ethernet	Supported, up to 7500 W

1. The kVA rating listed for the power supply should be used as the sizing criteria for both UPS outputs as well as standard circuits and transformers to power a switch.

Table A-36 list the 9000 W AC-input power supply LEDs and their meanings.

Table A-36 9000 W AC-input Power Supply LEDs

LED	Meaning
INPUT 1 OK INPUT 2 OK INPUT 3 OK	<ul style="list-style-type: none"> Green—Source AC voltage is OK. (Input voltage is 85 VAC or greater.) Off—Source AC voltage falls below 70 VAC, source AC is not present, or the power supply is turned off. <p>Note For an AC input voltage that is between 70 VAC and 85 VAC, the INPUT OK LED condition is indeterminate; it can be either green, off, or flashing green.</p>
FAN OK	<ul style="list-style-type: none"> Green—Power supply fan is operating properly. Off—Power supply fan failure is detected.
OUTPUT FAIL	<ul style="list-style-type: none"> Red—Problem with one or more of the DC-output voltages of the power supply is detected. Off—DC-output voltage with acceptable margins. <p>Note For proper operation of the OUTPUT FAIL LED, systems with single power supplies must be configured with a minimum of one fan tray assembly and one supervisor engine. Systems with dual power supplies must have a minimum configuration of one fan tray assembly, one supervisor engine, and one additional module. Failure to meet these minimum configuration requirements can cause a false power supply output fail signal.</p>

System software detects how many of the source AC input lines on the power supply are powered and at what voltage (low-line or high-line) they are operating at. In addition, the 12 VDC and the -50 VDC output lines are monitored allowing total output power to be determined.

In redundant mode, the switch uses one power supply as the primary supply and the second power supply as a backup. If the primary power supply fails, the second power supply immediately supports the switch without disruption to the switch operation.

Table A-37 shows the wattage output possible from a 9000 W AC-input power supply operating in redundant mode.

Table A-37 Redundant Mode Operation (9000 W AC-input Power Supply)

Power Supply 1			Watts @ 3.3 VDC	Watts @ 12 VDC (Data)	Watts @ -50 VDC (PoE)	Total Power (W)
Input 1	Input 2	Input 3				
110 VAC	—	—	40	960	1000	1100 (max)
110 VAC	110 VAC	—	40	1460	2000	2200 (max)
110 VAC	110 VAC	110 VAC	40	1460	2500	3300 (max)
220 VAC	—	—	40	1460	2500	3000 (max)
220 VAC	220 VAC	—	40	1960	5000	6000 (max)
220 VAC	220 VAC	220 VAC	40	1960	7500	9000 (max)



Note

In redundant mode, the two power supplies must have identical inputs and all inputs must be at the same voltage. If either of the two power supplies is unpowered, there is no redundancy.

In combined mode, each of the two power supplies provides approximately 83% of its capacity to the switch. This allows for greater utilization of the power supplies with increased PoE densities. In the event of a power supply failure, the system powers down all devices except the supervisor. During this time, there will be a temporary network outage while power is restored to the system. Table A-38 lists the power supply input voltage combinations, the power share ratio between the two supplies and the power available to the chassis.

Table A-38 Power Supplies Combined Mode Ratios and Capacities

PS1 Input Voltage 1/2/3	PS2 Input Voltage 1/2/3	12 VDC Share Ratio	-50 VDC Share Ratio	Watts @ 3.3 VDC	Watts @ 12 VDC (Data)	Watts @ -50 VDC (PoE)	Total Power (Watts)
110/110/110	110/110/110	45/55	40/60	67	2628	4150	5423
110/110/—	110/110/—	45/55	40/60	67	2628	3320	3606
110/—/—	110/—/—	40/60	30/70	67	1594	1420	1789
110/110/110	110/110/—	40/60	40/60	67	2019	3457	4509
110/110/110	110/—/—	40/60	30/70	67	1616	2364	3596
110/110/—	110/—/—	40/60	30/70	67	1818	1650	2694
220/220/220	220/220/220	48/52	48/52	67	3762	14400	17206
220/220/—	220/220/—	45/55	40/60	67	3762	8300	10137
220/—/—	220/—/—	45/55	40/60	67	2628	4150	4930
220/220/220	220/220/—	45/55	45/55	67	2940	11250	13429
220/220/220	220/—/—	40/60	40/60	67	2168	8300	9893
220/220/—	220/—/—	45/55	40/60	67	2646	6225	7412

Table A-38 Power Supplies Combined Mode Ratios and Capacities (continued)

PS1 Input Voltage 1/2/3	PS2 Input Voltage 1/2/3	12 VDC Share Ratio	-50 VDC Share Ratio	Watts @ 3.3 VDC	Watts @ 12 VDC (Data)	Watts @ -50 VDC (PoE)	Total Power (Watts)
110/110/110	220/220/220	45/55	40/60	67	2628	4150	5423
110/110/—	220/220/—	45/55	40/60	67	2628	3320	3606
110/—/—	220/—/—	40/60	30/70	67	1594	1420	1789

9000 W Power Supply AC Power Cords

Table A-39 lists the specifications for the AC power cords that are available for the 9000 W AC-input power supply. The table includes references to power cord illustrations.



Note

All 9000 W AC-input power supply power cords have an IEC60320/C19 appliance plug at one end.

Table A-39 9000 W AC-Input Power Supply Power Cords

Locale	Power Cord Part Number	Length	Cordset Rating	AC Source Plug Type
Japan, North America 120 VAC operation	CAB-US515P-C19-US	9.8 ft (2.98 m)	15 A, 125 VAC	NEMA 5-15P  120354
Japan, North America (nonlocking) 200–240 VAC operation	CAB-US620P-C19-US	13.2 ft (4.02 m)	20 A, 250 VAC	NEMA 6-20 non-locking  120355
Europe	CAB-AC-2800W-EU= CAB-CEE77-C19-EU=	13.2 ft (4.0 m)	16 A, 250 VAC	CEE 7/7  120357
International	CAB-AC-2800W-INT= CAB-I309-C19-INT=	13.6 ft (4.1 m)	20 A, 250 VAC	IEC 309  120360

Table A-39 9000 W AC-Input Power Supply Power Cords (continued)







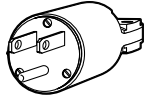
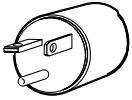
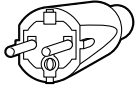
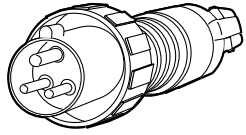

Locale	Power Cord Part Number	Length	Cordset Rating	AC Source Plug Type
Japan, North America (locking) 200–240 VAC operation	CAB-AC-2800W-TWLK= CAB-L620P-C19-US=	13.6 ft (4.1 m)	16 A, 250 VAC	NEMA L6-20  120361
Australia	CAB-AC-16A-AUS CAB-A3112-C19-AUS=	14 ft (4.3 m)	16 A, 250 VAC	AU20S3  275667
Argentina	CAB-IR2073-C19-AR=	14 ft (4.3 m)	16 A, 250 VAC	IRAM 2073  120356
China 200–240 VAC operation	CAB-9K16A-CH	14 ft (4.3 m)	16 A, 250 VAC	GB16C  275664
Switzerland	CAB-ACS-16	8 ft (2.9 m)	16 A, 250 VAC	G23  275665
India	CAB-SABS-C19-IND	14 ft (4.3 m)	16 A, 250 VAC	SABS 164-1  275666
United Kingdom	CAB-AC-2800W-INT CAB-I309-C19-INT	14 ft (4.3 m)	16A, 250 VAC	IEC 309  0360
Italy	CAB-C2316-C19-IT=	14 ft (4.3 m)	16 A, 250 VAC	CEI 23-16  120358

Table A-39 9000 W AC-Input Power Supply Power Cords (continued)

Locale	Power Cord Part Number	Length	Cordset Rating	AC Source Plug Type
Israel	CAB-S132-C19-ISRL=	14 ft (4.3 m)	16 A, 250 VAC	SI 16S3  130922
Brazil	CAB-EL224-C19-BR=	8 ft (2.9 m)	16 A, 250 VAC	NBR 14136  275665
UPS 220V	CAB-C19-CBN	9 ft (2.74 m)	20 A, 250 VAC	IEC-60320-C20  130923

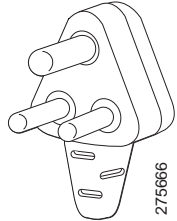
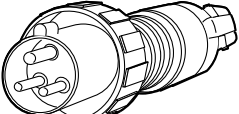
Remote Power Cycling Feature

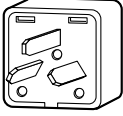
The 9000 W AC-input power supply is equipped with a remote power cycling feature that allows you to remotely turn on or turn off the power supply through an external relay controller box. Figure A-11 shows a typical remote power on/off setup. A three-position terminal block, located on the lower right quadrant of the power supply faceplate, provides the interface to the external relay controller box. (See Figure A-11.)

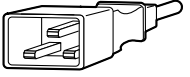
Figure A-11 Remote Power On/Off Feature Components (9000 W Power Supply)

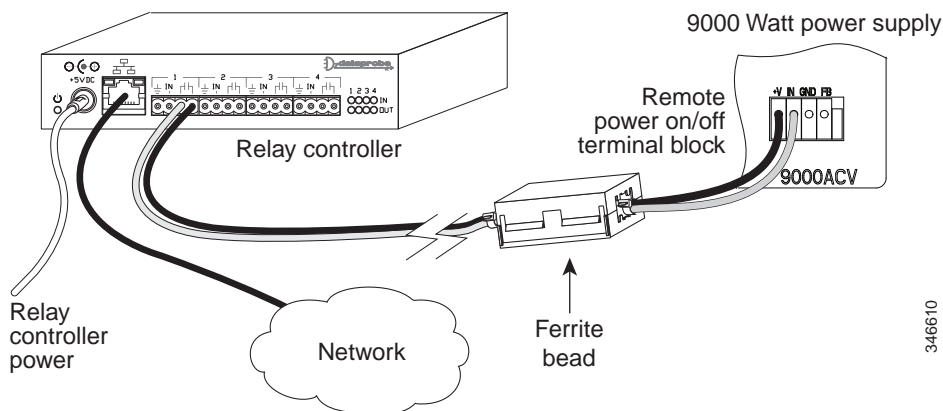

Terminal Block

The terminal block has four contacts labeled +V, IN, GND, and FB. Two control wires from an external relay controller box attach to either +V and IN or IN and GND. +V and IN are used when the relay controller box contains a normally-open (NO) type of relay. IN and GND are used when using an RS-232 interface.

Ferrite Bead

A plastic bag containing one ferrite bead and two 4-inch plastic ties is included with the 9000 W power supply AC power cords. The ferrite bead is a passive device that limits high-frequency interference on interface and control cables and is only required when you install the remote power-cycling feature that is supported by the 9000 W power supply. The ferrite bead is installed on the two control wires that come from the relay controller box to the terminal block on the 9000 W power supply. The ferrite bead should be installed as close as possible to the power supply terminal block for the bead to be effective. You do not need the ferrite bead for 9000 W power supply installations that do not include the remote power-cycling feature.

Remote Power-Cycling Operation

This feature allows you to remotely power cycle the Catalyst 4500 E-series switch using any appropriate third-party relay controller. This feature eliminates the need for you to have access to the supervisor engine console or CLI to control power cycling. [Table A-34](#) lists the relay controller box relay type, the corresponding power supply terminal block positions, and a description of the power-cycling operation.

Table A-40 9000 W Power Supply Relay Controller Switch Settings and Operation

External Relay Controller Box Relay Type	Power Supply Terminal Block Positions Used	Remote Power-Cycling Operation
Normally open (NO) relay.	The +V pin is internally pulled up to 12 VDC with a 10 K ohms pull up resistor, and pin IN is connected to the input pin (either pin 1, 4, 10, or 13) of the line receiver.	<ul style="list-style-type: none"> Power supply cycled from on to off. The power supply is powered off by energizing the relay (relay contacts go from open to closed) for more than 5 seconds. Power supply cycled from off to on. The power supply is powered on by reenergizing the relay (relay contacts go from closed to open) after a 10 second delay.
RS232 driver.	Pin IN is connected to the input pin (either pin 1, 4, 10, or 13) of the line receiver, and pin GND is connected to ground. A capacitor of 1 uF should be used between the line receiver input and the ground to bypass noise peaks.	<ul style="list-style-type: none"> Power supply cycles from on to off. The power supply is powered off by RS-232 logic HI for more than 5 seconds. Power supply cycles from off to on— The power supply is powered on by RS-232 logic LO after a 10 second delay.
No relay attached. Remote power-cycling feature not installed.	—	—

Environmental Monitoring Feature

With the environmental monitoring and reporting feature, you can keep your system running by resolving adverse environmental conditions before a loss of operation.

The power supply monitors its own internal temperature and voltages. In the event of excessive internal temperature, the power supply shuts down to prevent damage. When the power supply returns to a safe operating temperature, it restarts. If the power supply output voltage is not within the specified range, the LED labeled OUTPUT FAIL will light. An instance of substantial output overvoltage can shut down the power supply.

An instance of substantial input overvoltage (greater than -75 VDC continuous) can damage the power supply input circuitry and can cause it to shut down permanently.

For a 1400 W DC power supply, the main power switch has an input range of -40.5 to -72 VDC, while the -48 V PoE operates over a range of -40.5 to -56 VDC. The PoE either fails to start or shuts down if exposed to greater than -56 VDC input. PoE recovers after you recycle input power within the proper voltage range. If the PoE shuts down due to input overvoltage (greater than -56 VDC), the main converter section does not shut down.

The supervisor engine monitors the status of each power supply and provides a status report through the switch software. For more details on how the supervisor engine monitors the power supplies, see the “Environmental Monitoring and Power Management” chapter of the *Catalyst 4500 Series Switch Cisco IOS Software Configuration Guide*.

Power Redundancy

All Catalyst 4500 E-switches offer 1+1 power redundancy, so that in the event of a power interruption the switch can still operate using power from another circuit. The power supplies can also run in a combined mode so that chassis can have power from both supplies at once. Use the **power redundancy-mode** command to configure combined mode. Redundant mode is the default.

Catalyst 4500 E-switches support power supply redundancy only between power supplies of equal wattage and type. A mix of power supplies is not supported. The second power supply recognized is placed into errdisable mode.

A more detailed discussion of power redundancy is in the “Environmental Monitoring and Power Management” chapter of the software configuration guide. Refer to the appropriate guide for your software release.



Repacking a Switch

This appendix describes how to return your Catalyst 4500 E-series switch to the factory and how to repack your switch in preparation for shipping. [Table B-1](#) lists the packaging dimensions and weights for the Catalyst 4500 E-series chassis.

Table B-1 Chassis Packaging Dimensions and Weights

Chassis	Packaging Dimensions (L x W x D)	Weight (Approximate)
Catalyst 4503-E	23.25 x 21.00 x 19.75 in. (59.05 x 21.25 x 50.16 cm)	75 lb (34.02 kg)
Catalyst 4506-E	26.50 x 23.50 x 19.75 in. (67.31 x 59.69 x 50.16 cm)	110 lb (49.89 kg)
Catalyst 4507R-E	28.25 x 23.50 x 19.75 in. (71.76 x 59.69 x 50.16 cm)	108 lb (48.99 kg)
Catalyst 4510R-E	33.00 x 24.38 x 24.25 in. (83.82 x 61.92 x 61.60 cm)	161 lb (73.03 kg)
Catalyst 4507R+E	28.25 x 23.50 x 19.75 in. (71.76 x 59.69 x 50.16 cm)	108 lb (48.99 kg)
Catalyst 4510R+E	33.00 x 24.38 x 24.25 in. (83.82 x 61.92 x 61.60 cm)	161 lb (73.03 kg)

**Tip**

For additional information about the Cisco Catalyst 4500 E-series switches (including configuration examples and troubleshooting information), see the documents listed on this page:

<http://www.cisco.com/en/US/products/hw/switches/ps4324/index.html>

To repack the switch using the original packaging material, follow these steps:

- Step 1** Slide the pieces of the packing foam over the Catalyst 4500 E-series switch. (See [Figure B-1](#).)
- Step 2** Place the accessory kit in the box or poly bag provided.
- Step 3** Place the switch (with packing foam pieces) into the packing carton.
- Step 4** Fold in the top flaps of the packing carton and seal with packing tape.

Figure B-1 Catalyst 4500 E-Series Switch Packing Material

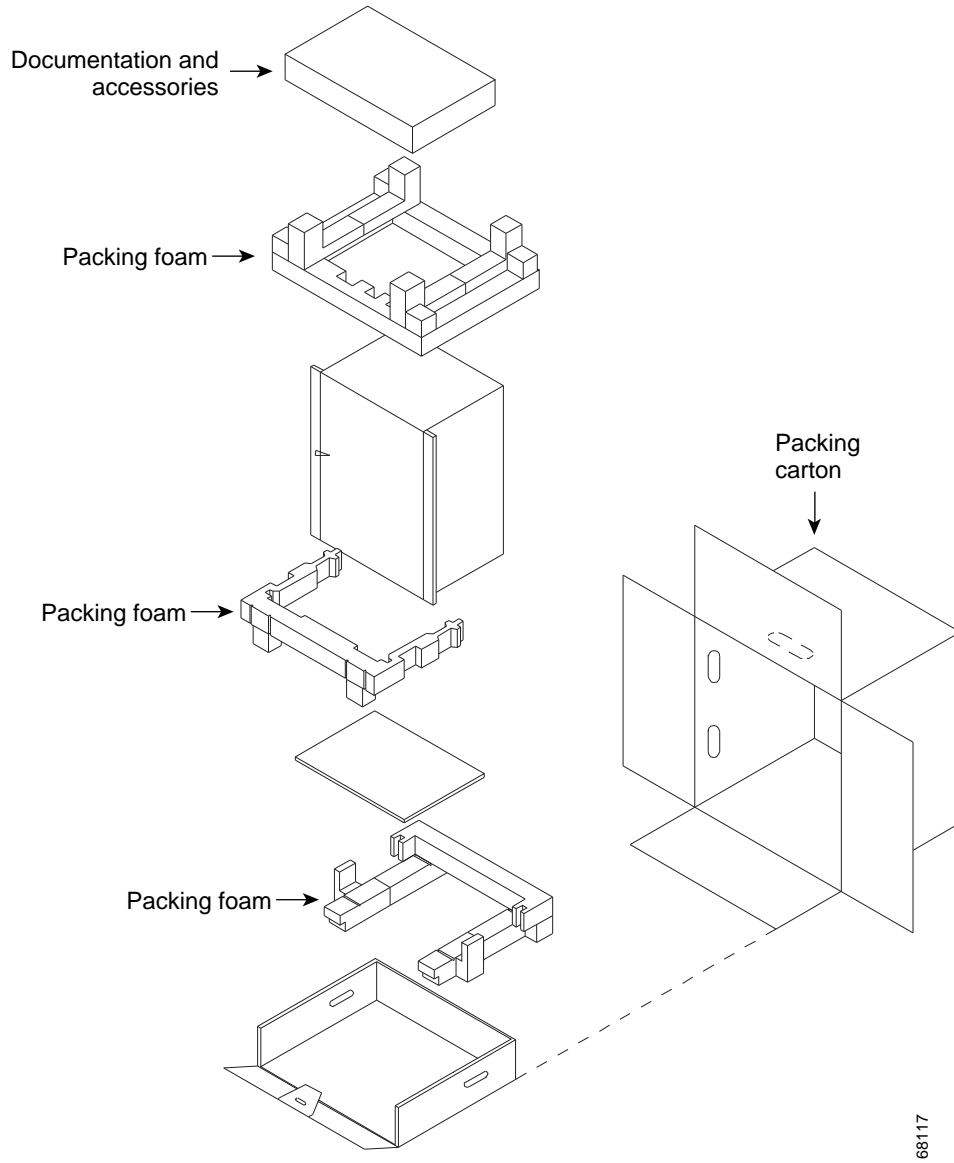

68117



Initial Configuration for the Switch

Revised: October 25, 2011

This appendix provides an initial setup procedure for a switch and contains the following topics:

- [Connecting to the Switch, page C-2](#)
- [Starting the Terminal-Emulation Software, page C-2](#)
- [Connecting to a Power Source, page C-2](#)
- [Entering the Initial Configuration Information, page C-3](#)

**Tip**

For additional information about the Cisco Catalyst 4500 E-series switches (including configuration examples and troubleshooting information), see the documents listed on this page:

<http://www.cisco.com/en/US/products/hw/switches/ps4324/index.html>

**Note**

You need to provide the Category 5 straight-through cables to connect the switch ports to other Ethernet devices.

**Note**

If you move a supervisor engine from a Catalyst 4500 series chassis to a Catalyst 4503-E chassis or Catalyst 4506-E chassis, it must use Cisco IOS Release 12.2(37)SG or later releases. See the release note for software upgrade procedures if needed:

http://www.cisco.com/en/US/docs/switches/lan/catalyst4500/release/note/OL_5184.html#wp305142

Connecting to the Switch

You must use the console port to perform the initial configuration. To connect the switch console port to a PC, use an RJ-45-to-DB-9 adapter cable.

To connect the PC or terminal to the switch, follow these steps:

-
- Step 1** Using an RJ-45-to-DB-9 adapter cable, insert the RJ-45 connector into the console port that is located on the front of the supervisor engine.
 - Step 2** Attach the DB-9 female DTE of the adapter cable to a PC serial port, or attach an appropriate adapter to the terminal.
-

Starting the Terminal-Emulation Software

Before you power on the switch, start the terminal-emulation session so that you can see the output display from the power-on self-test (POST).

The terminal-emulation software—frequently a PC application such as Hyperterminal or ProcommPlus—makes communication between the switch and your PC or terminal possible.

To start the terminal emulation software, follow these steps:

-
- Step 1** Start the terminal-emulation program if you are using a PC or terminal.
 - Step 2** Start a terminal-emulation session.
 - Step 3** Configure the baud rate and character format of the PC or terminal to match these console port default characteristics:
 - 9600 baud
 - 8 data bits
 - 1 stop bit
 - No parity
 - None (flow control)
-

Connecting to a Power Source

To connect to a power source, follow these steps:

-
- Step 1** If you are using an AC-input power supply, connect one end of the supplied AC power cord to the power connector on the switch, and then connect the other end of the power cable to a grounded AC outlet.
 - Step 2** If you are using a DC-input power supply, see the instructions on how to install the DC power supply in [Chapter 3, “Installing the Switch.”](#)
-

As the switch powers on, it begins the POST, which is a series of tests that runs automatically to ensure that the switch functions properly.

The POST lasts approximately 1 minute. After the POST is complete, the system and status LEDs remain green.

If the switch fails POST, the system LED turns amber.

**Note**

POST failures are usually fatal. Call Cisco TAC if your switch does not pass the POST.

If you started the terminal-emulation program before you powered on your switch, the PC or terminal displays the bootloader sequence. You need to press Enter to display the setup program prompt.

Entering the Initial Configuration Information

To set up the switch, you need to assign an IP address and other configuration information necessary for the switch to communicate with the local routers and the Internet. The minimal configuration provided here does not cover most of the features; it simply allows you to perform other configuration tasks using a Telnet connection from your management network. To configure other features and interfaces, see the Software Configuration Guide for your release.

IP Settings

You will need this information from your network administrator:

- Switch IP address
- Subnet mask (IP netmask)
- Default gateway (router)
- Enable secret password
- Enable password
- Telnet password

Performing the Initial Configuration

To complete the initial configuration for the switch, follow these steps:

Step 1 At the terminal prompt, enter the **enable** command to enter privileged exec mode.

```
Switch> enable
Password: password
Switch#
```

Step 2 Set the system time using the **clock set** command in privileged EXEC mode.

```
Switch# clock set 20:09:01 3 Apr 2006
```

Step 3 Verify the change by entering the **show clock** command.

```
Switch# show clock
20:09:06.079 UTC Thu Apr 3 2006
```

- Step 4** Enter the **configure terminal** command to enter global configuration mode.

```
Switch# configure terminal  
Enter configuration commands, one per line. End with CNTL/Z.  
Switch (config)#
```

- Step 5** Configure the system prompt and hostname for the switch, and press **Return**. To remove the new prompt and return the prompt to its default, use the **no hostname** command.

```
Switch (config)# hostname Switch1
```

- Step 6** Use the **banner motd** global configuration command to set location information in the login banner. You can also set a system contact using this command.

```
Switch1(config)# banner motd c 170 West Tasman Drive, San Jose, CA c
```

or

```
Switch1 (config)# banner motd c 170 West Tasman Drive, San Jose, CA; Tech Support 408 123  
4567 c
```

- Step 7** Configure an enable secret password, and press **Return**.

The password can be from 1 to 25 alphanumeric characters, can start with a number, is case sensitive, allows spaces, but ignores leading spaces. The secret password is encrypted and the enable password is in plain text.

```
Switch1 (config)# enable secret SecretPassword
```

- Step 8** Configure an enable password, and press **Return**.

```
Switch1 (config)# enable password EnablePassword
```

- Step 9** Configure a virtual terminal (Telnet) password, and press **Return**.

The password can be from 1 to 25 alphanumeric characters, is case sensitive, allows spaces, but ignores leading spaces.

```
Switch1 (config)# password terminal-password  
Switch1 (config)# line vty 0 15
```

- Step 10** Configure the interface that connects to the management network. (The IP address and subnet mask shown are for example only. Use an address appropriate for your network.)

```
Switch1 (config)# ip routing  
Switch1 (config)# interface gigabitethernet 3/24  
Switch1 (config-if)# no switchport  
Switch1 (config-if)# no shutdown  
Switch1 (config-if)# ip address 10.4.120.106 255.0.0.0  
Switch1 (config-if)# exit
```

- Step 11** Exit from global configuration mode:

```
Switch (config)# exit  
Switch #
```

Step 12 View the configuration that you have just created and confirm that it is what you want.

```
Switch1# show run
!
hostname Switch1
!
banner motd ^C
170 West Tasman Drive, San Jose, CA ^C
!

!--- Output suppressed.
```

Step 13 Configure a default route.

```
Switch1(config)#ip route 0.0.0.0 0.0.0.0 172.16.1.1
```

Step 14 Verify the IP information by using the **show ip interface brief** and **show ip route** commands.

```
Switch1# show ip interface brief

Interface          IP-Address      OK?  Method      Status      Protocol
Vlan1              10.4.220.206   YES  manual      up          up
FastEthernet1     unassigned     YES  unset       up          up

!--- Output suppressed.
Switch1# show ip route
Codes: C - connected, S - static, I - IGRP, R - RIP, M - mobile, B - BGP
       D - EIGRP, EX - EIGRP external, O - OSPF, IA - OSPF inter area
       N1 - OSPF NSSA external type 1, N2 - OSPF NSSA external type 2
       E1 - OSPF external type 1, E2 - OSPF external type 2, E - EGP
       i - IS-IS, L1 - ISIS level-1, L2 - ISIS level-2, ia - ISIS inter area
       * - candidate default, U - per-user static route, o - ODR
       P - periodic downloaded static route

Gateway of last resort is 172.16.1.1 to network 0.0.0.0

     172.16.0.0/24 is subnetted, 1 subnets
C       172.16.1.0 is directly connected, Vlan1
S*    0.0.0.0/0 [1/0] via 172.16.1.1
Switch1#
```

Step 15 Save the running configuration:

```
Switch1# copy system:running-config nvram:startup-config
```

You have now completed the initial configuration of the switch, so you can now configure other interfaces and features over a network connection without having to directly connect to the console port of the supervisor engine.

To use the CLI to perform additional configuration or management tasks, enter commands at the Switch> prompt through the console port by using a terminal program or through the network by using Telnet. For configuration information, see the switch software configuration guide or the switch command reference.

■ Entering the Initial Configuration Information



REVIEW DRAFT - CISCO CONFIDENTIAL

INDEX

Numerics

10/100BASE-T

port LEDs [5-8](#)

1000BASE-X

port and status LEDs (figure) [5-8](#)

1000 W power supplies

AC power cords [A-4](#)

1300 W power supplies

AC power cords [A-8](#)

1400 W power supplies

AC power cords [A-13](#)

2800 W AC-input power supply LEDs [A-26](#)

2800 W power supplies

AC power cords [A-27](#)

4200 W AC-input power supplies

features [A-28](#)

4200 W AC-input power supply LEDs [A-31](#)

4200 W power supplies

AC power cords [A-32](#)

6000 W AC-input power supplies

features [A-35](#)

remote power cycling feature [A-40](#)

remote power cycling terminal block [A-40](#)

6000 W power supplies

AC power cords [A-38](#)

9000W AC-input power supplies

AC power cords supported [A-47](#)

combined mode operation [A-46](#)

features (figure) [A-42](#)

LED meanings [A-45](#)

platforms supported [A-42](#)

redundant mode power output [A-46](#)

remote power cycling feature [A-49](#)

specifications (table) [A-43](#)

A

AC-input power cords

1000 W power supply [A-4](#)

1300 W power supply [A-8](#)

1400 W power supply [A-13](#)

2800 W power supply [A-27](#)

4200 W power supply [A-32](#)

6000 W power supply [A-38](#)

AC-input power supplies

environmental monitoring [A-51](#)

figure [4-3](#)

handling (figure) [4-6](#)

installing [4-7](#)

removing [4-5](#)

replacing [4-7](#)

source circuit requirements [2-12](#)

troubleshooting [5-4](#)

verifying operation [4-8](#)

See also DC-input power supplies

airflow

Catalyst 4503-E switches (table) [1-5](#)

Catalyst 4506-E switches (table) [1-9](#)

Catalyst 4507R+E switches (table) [1-21](#)

Catalyst 4507R-E switches (table) [1-13](#)

Catalyst 4510R+E switches (table) [1-25](#)

Catalyst 4510R-E switches (table) [1-17](#)

B

boot process

troubleshooting [5-2](#)branch circuit requirements [2-12](#)**C**

cabling

requirements and guidelines [2-14](#)

Catalyst 4503-E switches

chassis dimensions [1-5](#)fan trays [1-3](#)front view [1-2](#)power supplies [1-4](#)repacking [B-1](#)supervisor engines [1-3](#)

Catalyst 4506-E switches

attaching cable guides (figure) [3-7](#)chassis dimensions [1-9](#)fan trays [1-7](#)front view [1-6](#)installing in racks (figure) [3-6](#)power supplies [1-8](#)repacking [B-1](#)supervisor engines [1-7](#)

Catalyst 4507R+E switches

chassis dimensions [1-21](#)fan trays [1-19](#)power supplies [1-20](#)supervisor engines [1-19](#)

Catalyst 4507R-E switches

chassis dimensions [1-13](#)description [1-10](#)fan trays [1-11](#)front view [1-10](#)power supplies [1-12](#)supervisor engines [1-11](#)

Catalyst 4510R+E switches

chassis dimensions [1-25](#)fan trays [1-23](#)power supplies [1-24](#)supervisor engines [1-23](#)

Catalyst 4510R-E switches

chassis dimensions [1-17](#)description [1-14](#)fan trays [1-15](#)front view [1-14](#)power supplies [1-16](#)supervisor engines [1-15](#)category 5e static electricity caution [2-6, 2-9, 2-14](#)category 6a static electricity caution [2-6, 2-9, 2-14](#)category 6 static electricity caution [2-6, 2-9, 2-14](#)

chassis dimensions

See Catalyst 4503-E switches; Catalyst 4506-E switches;

See Catalyst 4506-E switches; Catalyst 4506-E switches;

See Catalyst 4507R+E switches; Catalyst 4507R+E switches;

See Catalyst 4507R-E switches; Catalyst 4507R-E switches;

See Catalyst 4510R+E switches; Catalyst 4510R+E switches;

See Catalyst 4510R-E switches; Catalyst 4510R-E switches;

components

troubleshooting [5-4 to 5-19](#)

connecting

system ground [3-7 to 3-9](#)terminals [3-10](#)to console port [C-2](#)uplink ports [3-11](#)

console port

connecting to [C-2](#)

conventions

warnings [1-3](#)

D

DC-input power supplies

- connecting system ground [3-8](#)
- environmental monitoring [A-51](#)
- figure [A-15, A-18](#)
- handling (figure) [4-12](#)
- installing [4-12](#)
- removing [4-8](#)
- replacing [4-12](#)
- See also AC-input power supplies
- troubleshooting [5-4](#)
- verifying operation [4-14](#)

dimensions

- Catalyst 4503-E switches (table) [1-5](#)
- Catalyst 4506-E switches (table) [1-9](#)
- Catalyst 4507R+E switches (table) [1-21](#)
- Catalyst 4507R-E switches (table) [1-13](#)
- Catalyst 4510R+E switches (table) [1-25](#)
- Catalyst 4510R-E switches (table) [1-17](#)

disconnecting

- ground connections (warning) [4-10](#)

documentation

- conventions [1-2](#)

E

environmental monitoring

- power supplies [A-51](#)

ESD

- guidelines [2-10](#)
- preventing [2-10](#)

Ethernet management ports

- LEDs [5-3](#)
- troubleshooting [5-3](#)

F

FAIL LEDs

- checking [4-8](#)

- verifying power supply status [4-14](#)

fan assemblies

- booting [5-2](#)
- installing [4-15](#)
- removing [4-14](#)
- troubleshooting [5-6](#)
- verifying installation [4-16](#)

FAN OK LED

- checking [4-8](#)

ferrite bead [A-41, A-50](#)

field-replaceable units

- See FRUs

Flash code

- troubleshooting [5-3](#)

FRUs

- AC-input power supplies [4-5 to 4-8](#)
- DC-input power supplies [4-8 to 4-14](#)
- fan assemblies [4-14 to 4-16](#)

G

GOOD LEDs

- checking [4-8](#)
- troubleshooting [5-4](#)
- verifying power supply status [4-14](#)

grounding

- connecting systems [3-8](#)

grounding. See system ground

ground wire

- figure [4-10, 4-11](#)

H

help

- See TAC

hot swapping

- fan assemblies [4-14](#)

humidity



REVIEW DRAFT - CISCO CONFIDENTIAL

Catalyst 4503-E switch specifications

(table) [1-5](#)

Catalyst 4506-E switch specifications (table) [1-9](#)

Catalyst 4507R+E switch specifications (table) [1-21](#)

Catalyst 4507R-E switch specifications (table) [1-12](#)

Catalyst 4510R+E switch specifications (table) [1-25](#)

I

installation

connecting to a power source [C-2](#)

starting the terminal-emulation software [C-2](#)

installing

AC-input power supplies [4-5 to 4-8](#)

DC-input power supplies [4-8 to 4-14](#)

fan assemblies [4-14 to 4-16](#)

installing switches in racks [3-4 to ??](#)

L

LEDs

checking power supplies [5-3](#)

checking supervisor engines [5-2](#)

POST results [C-3](#)

See also specific types of LEDs

LINK LEDs (table) [5-8](#)

M

Mux buffers [4-16, 5-7](#)

O

OUTPUT FAIL LED

environmental monitoring [A-51](#)

P

packaging materials [B-1](#)

port status LEDs [5-9](#)

POST

LEDs [C-3](#)

power cords

See AC-input power cords

power requirements

branch circuit requirements [2-12](#)

site preparation [2-12](#)

UPS selection [2-12](#)

power supplies

Catalyst 4503-E switches [1-4](#)

Catalyst 4506-E switches [1-8](#)

Catalyst 4507R+E switches [1-20](#)

Catalyst 4507R-E switches [1-12](#)

Catalyst 4510R+E switches [1-24](#)

Catalyst 4510R-E switches [1-16](#)

DC power cable leads color coding [2-13](#)

LEDs [5-3](#)

R

rack-mounting

switches [3-5](#)

rack-mount kits

guidelines [3-2](#)

Redundancy modules [4-16, 5-7](#)

remote power cycling feature

components (figure) [A-40, A-49](#)

- ferrite bead [A-41, A-50](#)
- operation [A-41, A-50](#)
- overview [A-40, A-49](#)
- switch settings and operation [A-41, A-50](#)

removing

- AC-input power supplies [4-5](#)
- DC-input power supplies [4-8](#)

- repacking switches [B-1](#)

replacing

- AC-input power supplies [4-7 to 4-8](#)
- DC-input power supplies [4-12 to 4-14](#)

S

- selecting a UPS [2-12](#)

- shipping instructions [B-1](#)

- show system command [4-8](#)

signaling and pinouts

- terminal setup [3-10](#)

site requirements

- altitude [2-5](#)
- corrosion [2-5](#)
- dust and contamination [2-5](#)
- EMI [2-5](#)
- humidity [2-4](#)
- power interruptions [2-6](#)
- shock and vibration [2-6](#)

startup

- troubleshooting [5-3](#)

supervisor engines

- uplink ports [3-11](#)

system ground

- accessory kit [3-8](#)
- connecting [3-8](#)
- grounding lug [3-8](#)
- guidelines [2-8](#)
- tools required [3-8](#)

T

TAC

- contacting [5-18](#)

temperature

- Catalyst 4503-E switches [1-5](#)
- Catalyst 4506-E switches [1-9](#)
- Catalyst 4507R+E switches [1-21](#)
- Catalyst 4507R-E switches [1-12](#)
- Catalyst 4510R+E switches [1-25](#)
- Catalyst 4510R-E switches [1-17](#)

- terminal-emulation software [C-2](#)

- troubleshooting [5-4](#)

- boot process [5-2](#)

- fan assemblies [5-6](#)

- power supplies [5-4](#)

- startup [5-3](#)

U

uplink ports

- connecting [3-11](#)

V

voltage

- specifications, DC-input power supply [A-18](#)

W

weight

- Catalyst 4503-E switches (table) [1-5](#)
- Catalyst 4506-E switches (table) [1-9](#)
- Catalyst 4507R+E switches (table) [1-21](#)
- Catalyst 4507R-E switches (table) [1-13](#)
- Catalyst 4510R+E switches (table) [1-25](#)
- Catalyst 4510R-E switches (table) [1-17](#)

