



## Switch Specifications

This appendix includes the following topics:

- [Environmental Specifications, on page 1](#)
- [Switch Dimensions, on page 2](#)
- [Power Requirements, on page 2](#)
- [Maximum Power Available for 3-kW AC Power Supplies, on page 3](#)
- [Maximum Power Available for 3-kW DC Power Supplies, on page 3](#)
- [Maximum Power Available for 3.5-kW Inputs \(AC\), on page 4](#)
- [Maximum Power Available for 3.5-kW Inputs \(DC\), on page 5](#)
- [Weights and Quantities for the Chassis, Modules, Fan Trays, and Power Supplies, on page 6](#)
- [Transceivers, Connectors, and Cables Used with Each I/O Module, on page 7](#)
- [Power Supply Cable Specifications , on page 34](#)

## Environmental Specifications

Environment		Specification
Temperature	Ambient operating	32 to 104°F (0 to 40°C)
	Ambient nonoperating	–40 to 158°F (–40 to 70°C)
Relative humidity	Ambient (noncondensing) operating	8 to 80%
	Ambient (noncondensing) nonoperating	5 to 90%
Altitude	Operating	–500 to 13,123 feet (–152 to 4,000 meters), agency certified 0 to 6500 feet (0 to 1980 meters)
	Storage	–1,000 to 30,000 feet (–305 to 9,144 meters)

## Switch Dimensions

Switch Component	Width	Depth	Height
Cisco Nexus 7706 chassis	17.3 inches (43.9 cm)	32.0 inches (81.3 cm)	15.75 inches (40.0 cm) (9 RU)
Cable management system and front door	18.3 inches (46.5 cm)	6.5 inches (16.5 cm)	— <sup>1</sup>

<sup>1</sup> The total height of the cable management system is within the height of the chassis. The cable management system is added to the front of the chassis but does not add any height to the chassis.

## Power Requirements

**Table 1: Power Requirements for the Cisco Nexus 7706 Switch Modules**

Component	Quantity	Maximum	Typical
Supervisor Modules	1 or 2 (same type if using 2)	—	—
Supervisor 2 Enhanced (N77-SUP2E)		265 W	137 W
Supervisor 3 Enhanced (N77-SUP3E)		150 W	110 W
F2 I/O Modules	1 to 4 (can mix types)	—	—
48-port 1- and 10-Gigabit Ethernet I/O module (N77-F248XP-23E)		500 W	451 W
F3 I/O Modules		—	—
48-port 1- and 10-Gigabit Ethernet I/O module (N77-F348XP-23)		480 W	450 W
24-port 40-Gigabit Ethernet I/O module (N77-F324FQ-25)		740 W	650 W
12-port 100-Gigabit Ethernet I/O module (N77-F312CK-26)		730 W	640 W
F4 I/O Module		—	—
30-port 100-Gigabit Ethernet I/O module (N77-F430CQ-36)		1000 W	730 W
M3 I/O Modules		—	—
48-port 1- and 10-Gigabit Ethernet I/O module (N77-M348XP-23L)		560 W	500 W
24-port 40-Gigabit Ethernet I/O module (N77-M324FQ-25L)	750 W	700 W	
12-port 100-Gigabit Ethernet I/O module (N77-M312CQ-26L)	1095 W	800 W	
Fabric Modules (N77-C7706-FAB-2)	3 to 6	80 W	65 W
Fabric Modules (N77-C7706-FAB-3)	3 to 6	85 W	65 W

Component	Quantity	Maximum	Typical
Fan Trays	—	—	—
38 mm Gen 1 Fan Tray (N77-C7706-FAN)	3	300 W	30 W
76 mm Gen 2 Fan Tray (N77-C7706-FAN-2)	3	300 W	30 W

## Maximum Power Available for 3-kW AC Power Supplies

The maximum power available for operations depends on the input power from your power source, the number and output capabilities of your power supplies, and the power redundancy mode that you use. The following table lists the amount of power available for 3-kW AC power supplies depending on power inputs, numbers of power supplies, and the mode used.

Power Inputs	Power Supplies	Combined Mode	Power Supply Redundancy Mode	Input Source Redundancy Mode	Full Redundancy Mode
1 input (220 V)	1	3000 W	—	—	—
	2	6000 W	3000 W	3000 W	3000 W
	3	9000 W	6000 W	3000 W	3000 W
	4	12000 W	9000 W	6000 W	6000 W
1 input (110 V)	1	1450 W	—	—	—
	2	2900 W	1450 W	1450 W	1450 W
	3	4350 W	2900 W	1450 W	1450 W
	4	5800 W	4350 W	2900 W	2900 W

## Maximum Power Available for 3-kW DC Power Supplies

The maximum power available for operations depends on the input power from your power source, the number and output capabilities of your power supplies, and the power redundancy mode that you use. The following table lists the amount of power available for 3-kW DC power supplies depending on power inputs, numbers of power supplies, and the mode used.

Power Inputs	Power Supplies	Combined Mode	Power Supply Redundancy Mode	Input Source Redundancy Mode	Full Redundancy Mode
1 input	1	3000 W	—	—	—
	2	6000 W	3000 W	3000 W	3000 W
	3	9000 W	6000 W	3000 W	3000 W
	4	12000 W	9000 W	6000 W	6000 W

## Maximum Power Available for 3.5-kW Inputs (AC)

The maximum power available for operations depends on the input power from your power source, the number and output capabilities of your power supplies, and the power redundancy mode that you use. The following table lists the amount of power available for 3.5-kW HVAC/HVDC power supplies depending on AC power inputs, number of power supplies, and the mode used.

Power Inputs	Power Supplies	Combined Mode	Power Supply Redundancy Mode	Input Source Redundancy Mode	Full Redundancy Mode
1 input (277 V)	1	3500 W	—	—	—
	2	7000 W	3500 W	3500 W	3500 W
	3	10,500 W	7000 W	3500 W	3500 W
	4	14,000 W	10,500 W	7000 W	7000 W
1 input (220/230 V)	1	3500 W	—	—	—
	2	7000 W	3500 W	3500 W	3500 W
	3	10,500 W	7000 W	3500 W	3500 W
	4	14,000 W	10,500 W	7000 W	7000 W
1 input (210 V)	1	3100 W	—	—	—
	2	6200 W	3100 W	3100 W	3100 W
	3	9300 W	6200 W	3100 W	3100 W
	4	12,400 W	9300 W	6200 W	6200 W

Power Inputs	Power Supplies	Combined Mode	Power Supply Redundancy Mode	Input Source Redundancy Mode	Full Redundancy Mode
1 input (110 V)	1	1500 W	—	—	—
	2	3000 W	1500 W	1500 W	1500 W
	3	4500 W	3000 W	1500 W	1500 W
	4	6000 W	4500 W	3000 W	3000 W



**Note** A combination of 3-kW AC and 3.5-kW HVAC/HVDC power supplies can be used.

## Maximum Power Available for 3.5-kW Inputs (DC)

The maximum power available for operations depends on the input power from your power source, the number and output capabilities of your power supplies, and the power redundancy mode that you use. The following table lists the amount of power available for 3.5-kW HVAC/HVDC power supplies depending on DC power inputs, number of power supplies, and the mode used.

Power Inputs	Power Supplies	Combined Mode	Power Supply Redundancy Mode	Input Source Redundancy Mode	Full Redundancy Mode
1 input (380 V)	1	3,500 W	—	—	—
	2	7,000 W	3,500 W	3,500 W	3,500 W
	3	10,500 W	7,000 W	3,500 W	3,500 W
	4	14,000 W	10,500 W	7,000 W	7,000 W
1 input (220/240 V)	1	3,500 W	—	—	—
	2	7,000 W	3,500 W	3,500 W	3,500 W
	3	10,500 W	7,000 W	3,500 W	3,500 W
	4	14,000 W	10,500 W	7,000 W	7,000 W
1 input (210 V)	1	3,100 W	—	—	—
	2	6,200 W	3,100 W	3,100 W	3,100 W
	3	9,300 W	6,200 W	3,100 W	3,100 W
	4	12,400 W	9,300 W	6,200 W	6,200 W



**Note** A combination of 3-kW DC and 3.5-kW HVAC/HVDC power supplies can be used.

## Weights and Quantities for the Chassis, Modules, Fan Trays, and Power Supplies

Component	Weight per Unit	Quantity
Cisco Nexus 7706 Chassis (N77-C7706)	145.0 lb (65.8 kg)	1
Supervisor module (N77-SUP2E)	8.5 lb (3.9 kg)	1 or 2
Supervisor module (N77-SUP3E)	7.7 lb (3.5 kg)	1 or 2
F2 Series I/O Module	—	1 to 4
48-port 1- and 10-Gigabit Ethernet I/O module (N77-F248XP-23E)	17.0 lb (7.7 kg)	
F3 Series I/O Modules	—	
48-port 1- and 10-Gigabit Ethernet I/O module (N77-F348XP-23)	17.0 lb (7.7 kg)	
24-port 40-Gigabit Ethernet I/O module (N77-F324FQ-25)	17.0 lb (7.7 kg)	
12-port 100-Gigabit Ethernet I/O module (N77-F312CK-26)	21.0 lb (9.5 kg)	
F4 Series I/O Module	—	
30-port 100-Gigabit Ethernet I/O module (N77-F430CQ-36)	23.14 lb (10.5 kg)	
M3 Series I/O Modules	—	
48-port 1- and 10-Gigabit Ethernet I/O module (N77-M348XP-23L)	18.95 lb (8.60 kg)	
24-port 40-Gigabit Ethernet I/O module (N77-M324FQ-25L)	18.0 lb (8.16 kg)	3 to 6
12-port 100-Gigabit Ethernet I/O module (N77-M312CQ-26L)	22.44 lb (10.18kg)	
Fabric Modules	—	
Fabric-2 module (N77-C7706-FAB-2)	5.6 lb (2.5 kg)	
Fabric-3 module (N77-C7706-FAB-3)	5.6 lb (2.5 kg)	

Component		Weight per Unit	Quantity
Fan Trays		—	3
	38 mm Gen 1 Fan Tray (N77-C7706-FAN)	5.3 lb (3.9 kg)	
	76 mm Gen 2 Fan Tray (N77-C7706-FAN-2)	7.75 lb (3.5 kg)	
Power Supplies		—	1 to 4
	3-kW AC power supply (N77-AC-3KW)	5.0 lb (2.3 kg)	
	3-kW DC power supply (N77-DC-3KW)	11.0 lb (5.0 kg)	
	3.5-kW HVAC/HVDC power supply (N77-HV-3.5KW)	11.0 lb (5.0 kg)	
Optional Components		—	0 or 1
	Front door (N77-C7706-FDK)		

## Transceivers, Connectors, and Cables Used with Each I/O Module

*Table 2: F3 Series 48-port, 1- and 10-Gigabit Ethernet (N77-F348XP-23) Transceivers and Cables*

Port Type	Transceiver or Connector	Cable Type
FET	FET-10G	10-Gigabit Fabric Extender Transceiver (FET) for FEX connections <sup>2</sup>

Port Type	Transceiver or Connector	Cable Type
SFP+	SFP-10G-SR	Multi-mode fiber (MMF)
	DWDM-SFP10G-xx.xx	Single-mode fiber (SMF)
	SFP-10G-ER	
	SFP-10G-LR	
	SFP-10G-LRM	
	SFP-10G-ZR	
	SFP-H10GB-CU1M	Twinax cable assembly, passive
	SFP-H10GB-CU1-5M	
	SFP-H10GB-CU2M	
	SFP-H10GB-CU2-5M	
SFP-H10GB-CU3M		
SFP-H10GB-CU5M	Twinax cable assembly, active	
SFP-H10GB-ACU7M		
SFP-H10GB-ACU10M	Active optical cable assembly	
SFP-10G-AOC1M		
SFP-10G-AOC3M		
SFP-10G-AOC5M		
SFP-10G-AOC7M		
SFP-10G-AOC10M		

<sup>2</sup> FETs are used only when connecting this I/O module to a Fabric Extender (FEX).

**Table 3: F3 Series 24-port, 40-Gigabit Ethernet (N77-F324FQ-25) Transceivers and Cables**

Port Type	Transceiver or Connector	Cable Type
FET	FET-40G	40-Gigabit Fabric Extender Transceiver (FET) for FEX connections <sup>3</sup>



Port Type	Transceiver or Connector	Cable Type
QSFP+	QSFP-40G-CSR4 QSFP-40G-SR4 QSFP-40G-SR-BD	Multi-mode fiber (MMF)
	QSFP-40G-LR4	Single-mode fiber (SMF)
	QSFP-H40G-ACU7M QSFP-H40G-ACU10M	Direct attach copper, active
	QSFP-4X10G-AC7M QSFP-4X10G-AC10M	40GBASE-CR4 QSFP+ to four SFP+ Twinax direct attach copper breakout cable active
	QSFP-H40G-AOC1M QSFP-H40G-AOC2M QSFP-H40G-AOC3M QSFP-H40G-AOC5M QSFP-H40G-AOC7M QSFP-H40G-AOC10M	40GBASE-AOC (Active Optical Cable) QSFP+ cable
	QSFP-4X10G-AOC1M QSFP-4X10G-AOC2M QSFP-4X10G-AOC3M QSFP-4X10G-AOC5M QSFP-4X10G-AOC7M QSFP-4X10G-AOC10M	40GBASE-AOC QSFP+ to four SFP+ breakout cable

<sup>3</sup> FETs are used only when connecting this I/O module to a Fabric Extender (FEX).

**Table 4: F3 Series 12-port, 100-Gigabit Ethernet (N77-F312CK-26) Transceivers and Cables**

Port Type	Transceiver or Connector	Cable Type
CPAK	CPAK-100G-SR10	Multi-mode fiber (MMF)
	CPAK-100G-LR4	Single-mode fiber (SMF)

**Table 5: F4 Series 30-port, 100-Gigabit Ethernet (N77-F430CQ-36) Transceivers and Cables**

Port Type	Transceiver or Connector	Cable Type
FET	FET-40G	40-Gigabit Fabric Extender Transceiver (FET) for FEX connections

Port Type	Transceiver or Connector	Cable Type
QSFP+ (QSFP28)	QSFP-100G-SR4-S QSFP-40G-CSR4 QSFP-40G-SR4 QSFP-40G-SR4-S	Multi-mode fiber (MMF), supports breakout
	QSFP-40G-SR-BD QSFP-40/100-SRBD	Multi-mode fiber (MMF), no breakout support
	QSFP-100G-CWDM4-S QSFP-100G-PSM4-S QSFP-100G-LR4-S QSFP-40G-ER4 QSFP-40G-LR4 QSFP-4x10G-LR-S	Single-mode fiber (MMF), supports breakout
	QSFP-4X10G-AOC1M QSFP-4X10G-AOC2M QSFP-4X10G-AOC3M QSFP-4X10G-AOC5M QSFP-4X10G-AOC7M QSFP-4X10G-AOC10M	QSFP to four SFP+ active optical breakout cables, supports breakout
		Active optical cable assembly, supports breakout

Port Type	Transceiver or Connector	Cable Type
	QSFP-100G-AOC1M	
	QSFP-100G-AOC2M	
	QSFP-100G-AOC3M	
	QSFP-100G-AOC5M	
	QSFP-100G-AOC7M	
	QSFP-100G-AOC10M	
	QSFP-100G-AOC15M	
	QSFP-100G-AOC20M	
	QSFP-100G-AOC25M	
	QSFP-100G-AOC30M	
	QSFP-H40G-AOC1M	
	QSFP-H40G-AOC2M	
	QSFP-H40G-AOC3M	
	QSFP-H40G-AOC5M	
	QSFP-H40G-AOC7M	
	QSFP-H40G-AOC10M	
	QSFP-H40G-AOC15M	

Table 6: M3 Series 48-port, 1- and 10-Gigabit Ethernet (N77-M348XP-23L) Transceivers and Cables

Port Type	Transceiver or Connector	Cable Type
SFP	GLC-TE	Category 5
	GLC-LH-SMD GLC-SX-MMD	Multi-mode fiber (MMF)
	CWDM-SFP-xxxx <b>Note</b> CWDM-SFP-xxxx is supported only with 1-Gigabit Ethernet I/O modules.	Single-mode fiber (SMF)
	DWDM-SFP-xxxx	
	GLC-BX-U	
	GLC-BX-D	
	GLC-EX-SMD	
GLC-LH-SMD GLC-ZX-SMD		

Port Type	Transceiver or Connector	Cable Type
SFP+	SFP-10G-SR	Multi-mode fiber (MMF)
	DWDM-SFP10G-xx.xx <b>Note</b> DWDM-SFP10G-C is not supported.	Single-mode fiber (SMF)
	SFP-10G-BXD-I	
	SFP-10G-BXU-I	
	SFP-10G-ER	
	SFP-10G-LR	
	SFP-10G-LRM	
SFP-10G-ZR		
	SFP-H10GB-CU1M SFP-H10GB-CU1-5M SFP-H10GB-CU2M SFP-H10GB-CU2-5M SFP-H10GB-CU3M SFP-H10GB-CU5M	Twinax cable assembly, passive
	SFP-H10GB-ACU7M SFP-H10GB-ACU10M	Twinax cable assembly, active
	SFP-10G-AOC1M SFP-10G-AOC2M SFP-10G-AOC3M SFP-10G-AOC5M SFP-10G-AOC7M SFP-10G-AOC10M	Active optical cable assembly

Table 7: M3 Series 24-port, 40-Gigabit Ethernet (N77-M324FQ-25L) Transceivers and Cables

Port Type	Transceiver or Connector	Cable Type
QSFP+	QSFP-40G-CSR4	Multi-mode fiber (MMF)
	QSFP-40G-SR4	
	QSFP-40G-SR4-S	
	QSFP-40G-SR-BD	
	QSFP-40G-ER4	Single-mode fiber (SMF)
	QSFP-40G-LR4	
	QSFP-40G-LR4-S	
	QSFP-4x10G-LR-S	
	WSP-Q40G-LR4L	
	QSFP-4X10G-AC7M	Direct-attach copper cable assembly
	QSFP-4X10G-AC10M	
	QSFP-4X10G-AOC1M	Active optical cable assembly
	QSFP-4X10G-AOC2M	
	QSFP-4X10G-AOC3M	
	QSFP-4X10G-AOC5M	
	QSFP-4X10G-AOC7M	
	QSFP-4X10G-AOC10M	
	QSFP-H40G-ACU7M	Direct attach copper, active
QSFP-H40G-ACU10M		
QSFP-H40G-AOC1M	Active optical cable assembly	
QSFP-H40G-AOC2M		
QSFP-H40G-AOC3M		
QSFP-H40G-AOC5M		
QSFP-H40G-AOC7M		
QSFP-H40G-AOC10M		
QSFP-H40G-AOC15M		

Table 8: M3 Series 12-port, 100-Gigabit Ethernet (N77-M312CQ-26L) Transceivers and Cables

Port Type	Transceiver or Connector	Cable Type
QSFP+ (QSFP28)	QSFP-100G-SR4-S	Multi-mode fiber (MMF)
	QSFP-40G-CSR4	
	QSFP-40G-SR4	
	QSFP-40G-SR4-S	
	QSFP-40/100-SRBD	
	QSFP-40G-SR-BD	
	QSFP-100G-CWDM4-S	Single-mode fiber (SMF)
	QSFP-100G-PSM4-S	
	QSFP-100G-LR4-S	
	QSFP-40G-ER4	
	QSFP-40G-LR4	
	QSFP-4x10G-LR-S	
	QSFP-H40G-ACU7M	Direct attach copper, active
	QSFP-H40G-ACU10M	
QSFP-4X10G-AOC1M	QSFP to four SFP+ active optical breakout cables	
QSFP-4X10G-AOC2M		
QSFP-4X10G-AOC3M		
QSFP-4X10G-AOC5M		
QSFP-4X10G-AOC7M		
QSFP-4X10G-AOC10M		
QSFP-4X10G-AC7M	QSFP to 4 SFP+ copper break-out cables	
QSFP-4X10G-AC10M		
		Active optical cable assembly

Port Type	Transceiver or Connector	Cable Type
	QSFP-100G-AOC1M	
	QSFP-100G-AOC2M	
	QSFP-100G-AOC3M	
	QSFP-100G-AOC5M	
	QSFP-100G-AOC7M	
	QSFP-100G-AOC10M	
	QSFP-100G-AOC15M	
	QSFP-100G-AOC20M	
	QSFP-100G-AOC25M	
	QSFP-100G-AOC30M	
	QSFP-H40G-AOC1M	
	QSFP-H40G-AOC2M	
	QSFP-H40G-AOC3M	
	QSFP-H40G-AOC5M	
	QSFP-H40G-AOC7M	
	QSFP-H40G-AOC10M	
	QSFP-H40G-AOC15M	

## 100-Gb CPAK Transceiver Specifications

The 100-Gigabit CPAK transceivers are used with the F3-Series 100-Gigabit I/O module (N77-F312CK-26).

For the cable specifications that apply to these transceivers, see the following table.

Transceiver	Cable Type	Connector Type	Wavelength (nm)	Core Size (microns)	Modal Bandwidth (MHz-km)	Maximum Cable Distance
CPAK-100GLR4	SMF	LC Duplex	1310	G.652	—	6.21 miles (10 km)
CPAK-100GSR10	MMF	24-fiber MPO/MTP	850	50.0	2000 (OM3)	328 feet (100 m)
				50.0	4700 (OM4)	492 feet (150 m)

For the environmental specifications, see the following table.

Parameter	Specification
Storage temperature	−40 to 158°F (−40 to 70°C)
Operating temperature	32 to 104°F (0 to 40°C)
Storage relative humidity	5 to 95 percent, noncondensing
Operating relative humidity	5 to 90 percent, noncondensing

## 100-Gb QSFP+ Transceiver Specifications



**Note** The 100-Gigabit QSFP+ transceivers are used with the M3-Series 100-Gigabit I/O module (N77-M312CQ-26L) and the F4-Series 100-Gigabit Ethernet I/O module (N77-F430CQ-36). These I/O modules support Forward Error Correction (FEC) with the 100-Gigabit QSFP+ transceivers. For more information, refer [FEC Support on Optic Modules](#).

For the cable specifications that apply to these transceivers, see the following table.

Transceiver	Cable Type	Connector Type	Wavelength (nm)	Core Size (microns)	Modal Bandwidth (MHz-km)	Maximum Cable Distance
QSFP-100G-SR4-S	MMF	12-fiber MPO	850	50.0 50.0	2000 (OM3) 4700 (OM4)	230 feet (70 m) over OM3 Multimode Fiber 328 feet (100 m) over OM4 Multimode Fiber
QSFP-100G-LR4-S	SMF	LC Duplex	1295, 1300, 1304, 1309	G.652	—	6.21 miles (10 km)
QSFP-100G-CWDM4-S	SMF	LC Duplex	1271, 1291, 1311, 1331	G.652	—	1.24 miles (2 km)
QSFP-100G-PSM4-S	SMF	12-fiber MPO	1310	G.652	—	1640 feet (500 m)
QSFP-100G-AOCxM	Active optical cable	QSFP+ to QSFP+	—	—	—	3.3 feet (1 m) 6.6 feet (2 m) 9.8 feet (3 m) 16.4 feet (5 m) 23 feet (7 m) 33 feet (10 m) 49.4 feet (15 m) 65.6 feet (20 m) 82 feet (25 m) 98.4 feet (30 m)
QSFP-40/100-SRBD	MMF	LC	855, 908	50.0 50.0	2000 (OM3) 4700 (OM4)	230 feet (70 m) 328 feet (100m)

For the optical specifications, see the following table.



Table 9:

Transceiver	Transceiver Type	Transmit Power (dBm)	Receive Power (dBm)	Transmit and Receive Wavelength (nm)
QSFP-100G-SR4-S	QSFP+	2.4 (maximum per lane) -8.4 (minimum per lane)	2.4 (maximum per lane) -5.2 (minimum per lane)	840 to 860 nm
QSFP-100G-LR4-S	QSFP+	4.5 (maximum per lane) -4.3 (minimum per lane)	4.5 (maximum per lane) -8.6 (minimum per lane)	Four lanes: 1295, 1300, 1304, 1309
QSFP-100G-CWDM4-S	QSFP+	2.5 (maximum per lane) -6.5 (minimum per lane)	2.5 (maximum per lane) -10 (minimum per lane)	Four lanes: 1271, 1291, 1311, 1331
QSFP-100G-PSM4-S	QSFP+	2.9 (maximum per lane) -9.4 (minimum per lane)	2 (maximum per lane) -26 (minimum per lane)	1295 to 1325
QSFP-40/100G-SRBD	QSFP+	+4 (100G), +5 (40G) (maximum per lane) -6 (100G), -4 (40G) (minimum per lane)	4 (100G), 5 (40G) (maximum per lane) -7.9 (100G), -6 (40G) (minimum per lane)	855, 908

For the environmental specifications, see the following table.

Parameter	Specification
Storage temperature	-40 to 185°F (-40 to 85°C)
Operating temperature	32 to 158°F (0 to 70°C)
Case temperature	-40 to 158°F (-40 to 70°C)
Storage relative humidity	5 to 95 percent

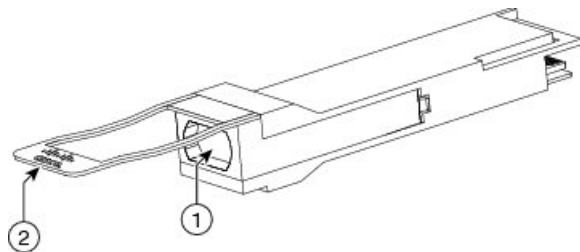
## 40-Gb QSFP+ Transceiver Specifications



**Note** The 40-Gigabit QSFP+ transceivers are used with the F3-Series 40-Gigabit I/O modules (N77-F324FQ-25), F4-Series 100-Gigabit I/O modules (N77-F430CQ-36), M3-Series 40-Gigabit I/O modules (N77-M324FQ-25L), and the M3-Series 100-Gigabit I/O modules (N77-M312CQ-26L).

The following figure identifies the major features of these transceivers.

**Figure 1:**



1	Optical bore	2	Pull tab
---	--------------	---	----------

For the cable specifications that apply to these transceivers, see the following table.

Transceiver	Cable Type	Connector Type	Wavelength (nm)	Core Size (microns)	Modal Bandwidth (MHz-km)	Maximum Cable Distance
FET-40G <b>Note</b> FET-40G is not supported with N77-M324FQ-25L and N77-M312CQ-26L.	MMF	QSFP+ to QSFP+	850	50.0 50.0 50.0	500 2000 4700	98 feet (30 m) 328 feet (100 m) 328 feet (100 m)
QSFP-H40G-ACUxM	Direct attach copper, active	QSFP+ to QSFP+	—	—	—	23 feet (7 m) 33 feet (10 m)
QSFP-H40G-AOCxM	Active optical cable	QSFP+ to QSFP+	—	—	—	3.3 feet (1 m) 6.6 feet (2 m) 9.8 feet (3 m) 16.4 feet (5 m) 23 feet (7 m) 33 feet (10 m) 49.4 feet (15 m)

Transceiver	Cable Type	Connector Type	Wavelength (nm)	Core Size (microns)	Modal Bandwidth (MHz-km)	Maximum Cable Distance
QSFP-40G-CSR4	MMF	12-fiber MTP/MPO	850	62.5	200	108 feet (33 m)
				50.0	500	269 feet (82 m)
				50.0	2000	984 feet (300 m)
				50.0	4700	1312 feet (400 m)
QSFP-40G-ER4	SMF	LC	1310	G.652	—	40 km <sup>4</sup>
QSFP-40G-LR4	SMF	LC Duplex	1310	G.652	—	6.21 miles (10 km)
QSFP-40G-SR4	MMF	PC or UPC	850	50.0	500 (OM2)	98 feet (30 m)
				50.0	2000 (OM3)	328 feet (100 m)
				50.0	4700 (OM4)	492 feet (150 m)
QSFP-4X10G-AOC <sub>x</sub> M	Active optical cable assembly	QSFP to four SFP+	-	-	-	3 feet (1 m)
						6.5 feet (2 m)
						9.8 feet (3 m)
						16.4 feet (5 m)
						23 feet (7 m)
33 feet (10 m)						
QSFP-4X10G-AC <sub>x</sub> M	Direct-attach copper cable assembly	QSFP to four SFP+	-	-	-	23 feet (7 m)
						33 feet (10 m)
QSFP-4X10G-LR-S	SMF	MPO-12	1310	G.652	-	10 km
QSFP-40G-SR-BD	MMF	LC Duplex	850/900	50.0	500 (OM2)	98 feet (30 m)
				50.0	2000 (OM3)	328 feet (100 m)
				50.0	4700 (OM4)	328 feet (100 m)
WSP-Q40G-LR4L	SMF	LC	1310	G.652	—	1.24 miles (2 km)

For the optical specifications, see the following table.

Transceiver	Transceiver Type	Transmit Power (dBm)	Receive Power (dBm)	Transmit and Receive Wavelength (nm)
QSFP-40G-CSR4	40GBASE-CSR4	0 (maximum per lane)	0 (maximum per lane)	840 to 860
		-7.3 (minimum per lane)	-9.9 (minimum per lane)	

Transceiver	Transceiver Type	Transmit Power (dBm)	Receive Power (dBm)	Transmit and Receive Wavelength (nm)
QSFP-40G-ER4	40GBASE-ER4	4.5 (maximum per lane) -2.7 (minimum per lane)	-4.5 (maximum per lane) -21.2 (minimum per lane)	Four lanes: 1271, 1291, 1311, 1331
QSFP-40G-LR4	40GBASE-LR4	2.3 (maximum per lane) -7 (minimum per lane)	2.3 (maximum per lane) -13.7 (minimum per lane)	Four lanes: 1271, 1291, 1311, 1331
QSFP-40G-SR4	40GBASE-SR4	-1.0 (maximum per lane*6) -7.6 (minimum per lane)	2.4 (maximum per lane) -9.5 (minimum per lane)	840 to 860 nm
QSFP-4X10G-LR-S	4x10GBASE-LR	0.5 (maximum per lane) -8.2 (minimum per lane)	0.5 (maximum per lane) -14.4 (minimum per lane)	1260 to 1355
QSFP-40G-SR-BD	40GBASE-SR-BiDi	5 (maximum per lane) -4 (minimum per lane)	5 (maximum per lane) -6 (minimum per lane)	832 to 918
WSP-Q40G-LR4L	40GBASE-LR4-Lite	2.3 (maximum per lane) -10 (minimum per lane)	2.3 (maximum per lane) -13.7 (minimum per lane)	Four lanes: 1271, 1291, 1311, 1331

For the environmental specifications, see the following table.

Parameter	Specification
Storage temperature	-40 to 185°F (-40 to 85°C)
Operating temperature	32 to 104°F (0 to 40°C)
Case temperature	-40 to 158°F (-40 to 70°C)
Storage relative humidity	5 to 95 percent

## 10-Gb SFP+ Optical Transceivers and Fabric Extender Transceivers

The following table indicates which 10-Gigabit SFP+ transceivers are used with the 10-Gigabit Ethernet (GE) I/O modules:

Transceiver	F2 Series 48-Port 1-/10-GE (N77-F248XP-23E)	F3 Series 48-port 1-/10-GE (N77-F348XP-23)	M3 Series 48-port 1-/10-GE (N77-M348XP-23L)
CWDM-SFP10G-xxxx	—	—	—
DWDM-SFP10G-xx.xx	X <b>Note</b> DWDM-SFP10G is not supported.	X <b>Note</b> DWDM-SFP10G is not supported.	X <b>Note</b> DWDM-SFP10G-C is not supported.
FET-10G	X	X	—
SFP-H10GB-CUxM	X	X	X
SFP-H10GB-ACUxM	X	X	X
SFP-10G-AOCxM	X	X	X
SFP-10G-BXD-I	—	X	X
SFP-10G-BXU-I	—	X	X
SFP-10G-ER	—	X	X
SFP-10G-LR	X	X	X
SFP-10G-LRM	X	X	X
SFP-10G-SR	X	X	X
SFP-10G-ZR	—	X	X

You can use the SFP-10G-SR, SFP-10G-LR, and the 10-Gigabit Fabric Extender Transceiver (FET) to connect the following I/O modules to Fabric Extenders (FEXs):

- F3 Series 48-port, 1- and 10-Gigabit Ethernet I/O module (N77-F348XP-23)

On the other end of the connections using the SFP-10G-SR, SFP-10G-LR, and FET transceivers, you can connect to the following FEXs:

- Cisco Nexus 2248TP FEX
- Cisco Nexus 2248TP-E FEX
- Cisco Nexus 2248PQ-E FEX
- Cisco Nexus 2232TM-E FEX
- Cisco Nexus 2232TM FEX
- Cisco Nexus 2232PP FEX

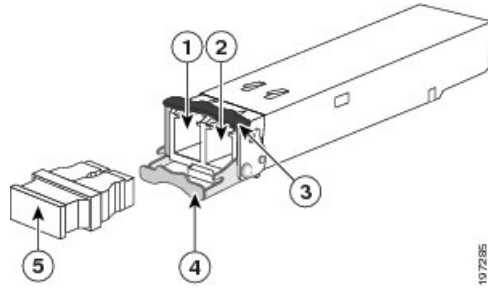
Using the QSFP-40G-SR4, QSFP-40G-LR4, and FET transceivers, you can connect the F3 Series 24-port 40-Gigabit Ethernet I/O module (N77-F324FQ-25) to the following FEXs:

- Cisco Nexus 2348TQ-10GE

- Cisco Nexus 2348UPQ
- Cisco Nexus B221BM

The following figure identifies the major features of these transceivers.

**Figure 2:**



1	Receive optical bore	4	Clasp shown in open position
2	Transmit optical bore	5	Dust plug
3	Clasp shown in closed position		

For the cable specifications that apply to the supported transceivers, see the following table. For information about the DWDM transceivers, see [10BASE-DWDM SFP+ Transceiver Specifications, on page 24](#)

Transceiver	Cable Type	Connector Type	Wavelength (nm)	Core Size (microns)	Modal Bandwidth (MHz-km)	Maximum Cable Distance
FET-10G	MMF	Dual LC/PC	850	50.0 50.0	500 2000	82 feet (25 m) 328 feet (100 m)
SFP-H10GB-CUxM	Twinax cable, passive, 30-AWG cable assembly	—	—	—	—	3.3 feet (1 m) 4.9 feet (1.5 m) 6.6 feet (2 m) 8.2 feet (2.5 m) 9.8 feet (3 m) 16.4 feet (5 m)
SFP-H10GB-ACUxM	Twinax cable, active, 30-AWG cable assembly	—	—	—	—	22.8 feet (7 m) 32.5 feet (10 m)

Transceiver	Cable Type	Connector Type	Wavelength (nm)	Core Size (microns)	Modal Bandwidth (MHz-km)	Maximum Cable Distance
SFP-10G-AOCxM	Active optical cable assembly	—	—	—	—	3.3 feet (1 m) 6.6 feet (2 m) 9.8 feet (3 m) 16.4 feet (5 m) 22.8 feet (7 m) 32.5 feet (10 m)
SFP-10G-BXD-I	SMF	—	1330	G.652	—	6.2 miles (10 km)
SFP-10G-BXU-I	SMF	—	1270	G.652	—	6.2 miles (10 km)
SFP-10G-ER	SMF	Dual LC/PC	1550	G.652 fiber	—	24.9 miles (40 km)
SFP-10G-LR	SMF	Dual LC/PC	1310	G.652 fiber	—	6.2 miles (10 km)
SFP-10G-LRM	SMF	Dual LC/PC	1310	G.652	—	984 feet (300 m)
SFP-10G-SR	MMF	Dual LC/PC	850	62.5 62.5 50 50 50	160 200 400 500 2000	85 feet (26 m) 108 feet (33 m) 216 feet (66 m) 269 feet (82 m) 984 feet (300 m)
SFP-10G-ZR	SMF		1550	G.652	—	49.7 miles (80 km)

For the optical specifications, see the following table.

Transceiver	Transceiver Type	Transmit Power (dBm)	Receive Power (dBm)	Transmit and Receive Wavelength (nm)
SFP-10G-ER	10GBASE-ER, 1550-nm SMF	4.0 (maximum per lane) -4.7 (minimum per lane)	-1.0 (maximum per lane) -15.8 (minimum per lane)	1530 to 1565 nm
SFP-10G-LR	10GBASE-LR, 1310-nm SMF	0.5 (maximum per lane) -8.2 (minimum per lane)	0.5 (maximum per lane) -14.4 (minimum per lane)	1260 to 1355 nm

Transceiver	Transceiver Type	Transmit Power (dBm)	Receive Power (dBm)	Transmit and Receive Wavelength (nm)
SFP-10G-LRM	10GBASE-LRM, 1310-nm SMF	0.5 (maximum per lane) -6.5 (minimum per lane)	0.5 (maximum per lane) -8.4 (minimum per lane) (in average) -6.4 (minimum per lane) (in OMA) <sup>4</sup>	1260 to 1355 nm
SFP-10G-SR	10GBASE-SR, 850-nm MMF	-1.2 (maximum per lane) <sup>5</sup> -7.3 (minimum per lane)	0.5 (maximum per lane) -8.2 (minimum per lane)	840 to 860 nm

<sup>4</sup> Both the average and the OMA specifications must be met simultaneously.

<sup>5</sup> The launch power shall be the lesser of the class 1 safety limit or the maximum receive power. Class 1 laser requirements are defined by IEC 60825-1:2001.

For the environmental specifications, see the following table.

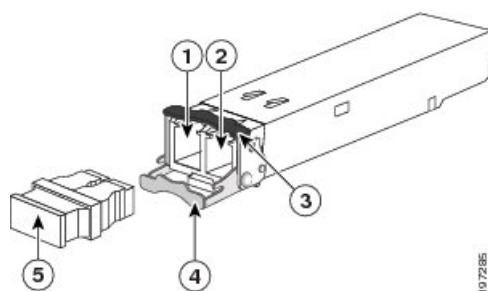
Parameter	Specification
Storage temperature	-40 to 185°F (-40 to 85°C)
Operating temperature	32 to 158°F (0 to 70°C)
Case temperature	-40 to 158°F (-40 to 70°C)
Module supply voltage	3.1 to 3.5 V

## 10GBASE-DWDM SFP+ Transceiver Specifications

The Dense Wavelength Division Multiplexing (DWDM) SFP+ transceivers are part of a DWDM optical network to provide high-capacity bandwidth across a fiber-optic network. There are 32 fixed-wavelength DWDM SFP+ transceivers that support the International Telecommunications Union (ITU) 100-GHz wavelength grid. These transceivers have duplex SC connectors. DWDM SFP+ transceivers can transmit and receive optical signals up to 50 miles (80 km) depending on the quality of the fiber-optic cable used.

DWDM SFP+ transceivers look like the typical 10GBASE-X SFP+ transceivers as shown in the following figure.

**Figure 3:**





1	Receive optical bore	4	Clasp shown in open position
2	Transmit optical bore	5	Dust plug
3	Clasp shown in closed position		

For the Cisco DWDM SFP+ transceiver cable specifications, see the following table.

Transceiver Type	Cable Type	Connector Type	Wavelength (nm)	ITU Channel
	SMF <sup>6</sup>	Dual LC/PC connector	1530.33, 1531.12, 1531.90, 1532.68, 1533.46, 1534.25, 1535.04, 1535.82, 1536.61, 1537.39, 1538.19, 1538.98, 1539.77, 1540.56, 1542.14, 1542.94, 1543.73, 1544.53, 1546.12, 1546.92, 1547.72, 1548.51, 1549.31, 1550.12, 1550.92, 1551.72, 1552.52, 1554.13, 1554.94, 1555.75, 1556.55, 1558.17, 1558.98, 1559.79, 1560.61, 1561.41	

Transceiver Type	Cable Type	Connector Type	Wavelength (nm)	ITU Channel
DWDM-SFP10G-30.33				59
DWDM-SFP10G-31.12				58
DWDM-SFP10G-31.90				57
DWDM-SFP10G-32.68				56
DWDM-SFP10G-33.47				55
DWDM-SFP10G-34.25				54
DWDM-SFP10G-35.04				53
DWDM-SFP10G-35.82				52
DWDM-SFP10G-36.61				51
DWDM-SFP10G-37.40				50
DWDM-SFP10G-38.19				49
DWDM-SFP10G-38.98				48
DWDM-SFP10G-39.77				47
DWDM-SFP10G-40.56				46
DWDM-SFP10G-41.35				45
DWDM-SFP10G-42.14				44
DWDM-SFP10G-42.94				43
DWDM-SFP10G-43.73				42
DWDM-SFP10G-44.53				41
DWDM-SFP10G-45.32				40
DWDM-SFP10G-46.12				39
DWDM-SFP10G-46.92				38
DWDM-SFP10G-47.72				37
DWDM-SFP10G-48.51				36
DWDM-SFP10G-49.32				35
DWDM-SFP10G-50.12				34
DWDM-SFP10G-50.92				33
DWDM-SFP10G-51.72				32
DWDM-SFP10G-52.52				31
DWDM-SFP10G-53.33				30
DWDM-SFP10G-54.13				29
DWDM-SFP10G-54.94				28
DWDM-SFP10G-55.75				27

Transceiver Type	Cable Type	Connector Type	Wavelength (nm)	ITU Channel
DWDM-SFP10G-56.55				26
DWDM-SFP10G-57.36				25
DWDM-SFP10G-58.17				24
DWDM-SFP10G-58.98				23
DWDM-SFP10G-59.79				22
DWDM-SFP10G-60.61				21
DWDM-SFP10G-61.41				20

<sup>6</sup> Single-mode fiber optic (SMF)

For the specifications that differentiate the 10GBASE-DWDM SFP+ transceivers, see the [10-Gigabit Ethernet Transceiver Modules Compatibility Matrix](#).

## 1-Gb SFP Transceivers

The following table indicates which 1-Gigabit SFP transceivers can be used with the 1-Gigabit Ethernet (GE) I/O modules:

Transceiver	F2 Series 48-Port 1-/10-GE (N77-F248XP-23E)	F3 Series 48-port 1-/10-GE (N77-F348XP-23)	M3 Series 48-port 1-/10-GE (N77-M348XP-23L)
CWDM-SFP-xxxx	X	X	X
DWDM-SFP-xxxx	X	X	X
GLC-BX-D	X	X	X
GLC-BX-U	X	X	X
GLC-EX-SMD	X	X	X
GLC-LH-SMD	X	X	X
GLC-SX-MMD	X	X	X
GLC-T	X	X	X
GLC-ZX-SMD	X	X	X
SFP-GE-T	X	X	X

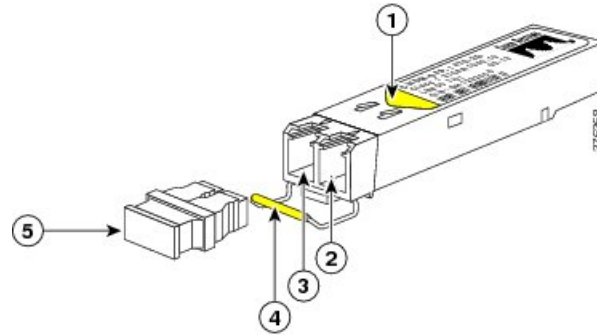
## 1000BASE-CWDM SFP Transceiver Cables

The Coarse Wavelength Division Multiplexing (CWDM) SFP transceivers are hot-swappable transceivers that you plug into SFP-compatible I/O modules. The CWDM SFP transceiver uses an LC optical connector to connect to a single-mode fiber-optic (SMF) cable. You can connect the CWDM SFPs to CWDM passive optical system optical add/drop multiplexer (OADM) modules or multiplexer/demultiplexer plug-in modules

using SMF cables. CWDM SFP transceivers can transmit and receive optical signals up to 61 miles (100 km) depending on the quality of the fiber-optic cable used.

CWDM SFP transceivers are color coded to indicate their designated optical wavelength. The following figure shows the CWDM transceiver, which looks like a standard 1000BASE-X SFP transceiver with a colored arrow and bail clasp to indicate the designated wavelength.

**Figure 4: CWDM SFP Transceiver (Yellow Color Code)**



1	Colored arrow on label specifies the wavelength	4	Bail clasp
2	Receive optical bore	5	Dust plug
3	Transmit optical bore		

Whenever the transceiver receive optical bores are not filled with optical cables, you should minimize the chance of contamination by plugging the transceiver with its dust plug.

For the Cisco CWDM SFP transceiver cable specifications, see the following table.

Transceiver Type	Cable Type	Connector Type	Wavelength (nm)	Core Size (microns)	Modal Bandwidth (MHz-km)	Maximum Cable Distance
CWDM-SFP-1470 CWDM-SFP-1490 CWDM-SFP-1510 CWDM-SFP-1530 CWDM-SFP-1550 CWDM-SFP-1570 CWDM-SFP-1590 CWDM-SFP-1610	SMF <sup>7</sup>	Dual LC/PC connector	1470, 1490, 1510, 1530, 1550, 1570, 1590, 1610	G.652 <sup>8</sup>	—	62 miles (100 km)

<sup>7</sup> Single-mode fiber optic (SMF)

<sup>8</sup> ITU-T G652 SMF as specified by the IEEE 802.32 standard.

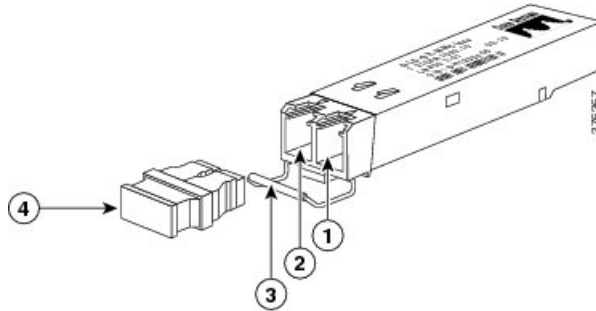
For the specifications that differentiate the 1000BASE-CWDM SFP transceivers, see the [Cisco Gigabit Ethernet Transceiver Modules Compatibility Matrix](#). For specifications and installation information that apply to all CWDM SFP transceivers, see the [Cisco SFP and SFP+ Transceiver Module Installation Notes](#).

## 1000BASE-DWDM SFP Transceiver Specifications

The Dense Wavelength Division Multiplexing (DWDM) SFP transceivers are part of a DWDM optical network to provide high-capacity bandwidth across a fiber-optic network. There are 40 fixed-wavelength DWDM SFP transceivers that support the International Telecommunications Union (ITU) 100-GHz wavelength grid. These transceivers have duplex SC connectors. DWDM SFP transceivers can transmit and receive optical signals up to 50 miles (80 km) depending on the quality of the fiber-optic cable used.

DWDM SFP transceivers look like the typical 1000BASE-X transceivers as shown in the following figure.

**Figure 5: 1000BASE-DWDM SFP Transceiver**



1	Receive optical bore	3	Bail clasp
2	Transmit optical bore	4	Dust plug

For the Cisco DWDM SFP transceiver cable specifications, see the following table.

Transceiver Type	Cable Type	Connector Type	Wavelength (nm)	ITU Channel
DWDM-SFP-3033	SMF <sup>9</sup>	Dual LC/PC connector	1530.33, 1531.12,	59
DWDM-SFP-3112			1531.90, 1532.68,	58
DWDM-SFP-3190			1534.25, 1535.04,	57
DWDM-SFP-3268			1535.82, 1536.61,	56
DWDM-SFP-3425			1537.39, 1538.19,	54
DWDM-SFP-3504			1539.98, 1539.77,	53
DWDM-SFP-3582			1540.56, 1542.14,	52
DWDM-SFP-3661			1542.94, 1543.73,	51
DWDM-SFP-3819			1544.53, 1546.12,	49
DWDM-SFP-3998			1546.92, 1547.72,	48
DWDM-SFP-3977			1548.51, 1550.12,	47
DWDM-SFP-4056			1550.92, 1551.72,	46
DWDM-SFP-4214			1552.52, 1554.13,	44
DWDM-SFP-4294			1554.94, 1555.75,	43
DWDM-SFP-4373			1556.55, 1558.17,	42
DWDM-SFP-4453			1558.98, 1559.79,	41
DWDM-SFP-4612			1560.61	39
DWDM-SFP-4692				38
DWDM-SFP-4772				37
DWDM-SFP-4851				36
DWDM-SFP-5012				34
DWDM-SFP-5092				33
DWDM-SFP-5172				32
DWDM-SFP-5252				31
DWDM-SFP-5413				29
DWDM-SFP-5494				28
DWDM-SFP-5575				27
DWDM-SFP-5655				26
DWDM-SFP-5817				24
DWDM-SFP-5898				23
DWDM-SFP-5979				22
DWDM-SFP-6061				21

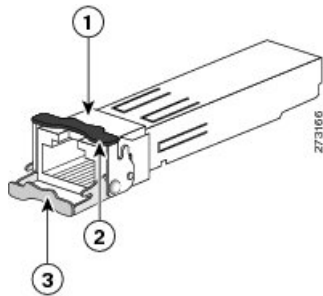
<sup>9</sup> Single-mode fiber optic (SMF)

For the specifications that differentiate the 1000BASE-DWDM SFP transceivers, see the [Cisco Gigabit Ethernet Transceiver Modules Compatibility Matrix](#). For specifications and installation information that apply to all CWDM SFP transceivers, see the [Cisco SFP and SFP+ Transceiver Module Installation Notes](#).

## 1000BASE-T and 1000BASE-X SFP Transceiver Specifications

The 1000BASE-T and 1000BASE-X SFPs are hot-swappable transceivers that you plug into SFP-compatible I/O modules. The 1000BASE-T transceiver, shown in the following figure, provides an RJ-45 connection for copper cables.

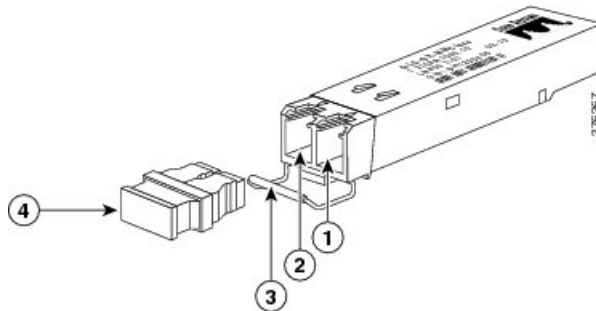
**Figure 6: 1000BASE-T SFP Transceiver**



1	RJ-45 connector	3	Bail clasp shown in the open (unlocked) position
2	Bail clasp shown in the closed (locked) position		

The 1000BASE-X transceiver, shown in the following figure, provides an optical connection for fiber-optic cables.

**Figure 7: 1000BASE-X SFP Transceiver**



1	Receive optical bore	3	Bail clasp
2	Transmit optical bore	4	Dust plug

For the 1000BASE-T and 1000BASE-X transceiver cable specifications, see the following table.

Transceiver Type	Cable Type	Connector Type	Wavelength (nm)	Core Size (microns)	Modal Bandwidth (MHz-km)	Maximum Cable Distance
1000BASE-BX10 (GLC-BX-U)	SMF <sup>10</sup>	Single LC/PC	1310	G.652 <sup>11</sup>	—	6.2 miles (10 km)



Transceiver Type	Cable Type	Connector Type	Wavelength (nm)	Core Size (microns)	Modal Bandwidth (MHz-km)	Maximum Cable Distance
1000BASE-BX10 (GLC-BX-D)	SMF <sup>10</sup>	Single LC/PC	1490	G.652 <sup>2</sup>	—	6.2 miles (10 km)
1000BASE-SX (GLC-SX-MMD)	MMF <sup>12</sup>	LC duplex	850	62.5	160	722 feet (220 m)
				62.5	200	902 feet (275 m)
				50.0	400	1640 feet (500 m)
				50.0	500	1804 feet (550 m)
1000BASE-LX (GLC-LH-SMD)	MMF <sup>3</sup>	LC duplex	1310	62.5	500	1804 feet (550 m) <sup>13</sup>
				50.0	400	1804 feet (550 m) <sup>4</sup>
				50.0	500	1804 feet (550 m) <sup>4</sup>
	SMF <sup>10</sup>	LC duplex	1310	G.652 <sup>2</sup>	—	6.2 miles (10 km)
1000BASE-ZX (GLC-ZX-SMD)	SMF <sup>10</sup>	LC duplex	1550	G.652 <sup>2</sup>	—	Approximately 43.4 to 60 miles (70 to 100 km) depending on link loss
1000BASE-T (GLC-T and SFP-GE-T)	Category 5, 5E, or 6 UTP/FTP	RJ-45	—	—	—	328 feet (100 meters)

<sup>10</sup> Single-mode fiber optic (SMF)

<sup>11</sup> ITU-T G652 SMF as specified by the IEEE 802.32 standard.

<sup>12</sup> Multimode fiber optic (MMF)

<sup>13</sup> You must use a mode-conditioning patch cord, as specified by the IEEE standard, regardless of the amount of span.

The transceivers that support Digital Optical Monitoring have a greater range of temperatures for operations, as shown in the following table.

Transceiver Type	Part Number	Digital Optical Monitoring Support	Operating Temperature	Storage Temperature
1000BASE-SX	GLC-SX-MMD	Yes	EXT <sup>14</sup>	-40 to 185°F (-40 to 85°C)
1000BASE-LX	GLC-LH-SMD	Yes	EXT <sup>5</sup>	
1000BASE-ZX	GLC-ZX-SMD	No	COM <sup>6</sup>	
1000BASE-T	GLC-T	—	COM <sup>6</sup>	
	SFP-GE-T	—	EXT <sup>5</sup>	

<sup>14</sup> Extended (EXT) temperature range is 23 to 185°F (-5 to 85°C)

## RJ-45 Module Connectors

The RJ-45 connector connects Category 3, Category 5, Category 5e, Category 6, or Category 6A foil twisted-pair or unshielded twisted-pair cable from the external network to the following module interface connectors:

- Supervisor modules
  - CONSOLE port
  - MGMT ETH port
- Fabric Extenders (Cisco Nexus 2232PP, 2232TM, 2232TM-E, 2248PQ, 2248TP, and 2248TP-E FEXs)

- 100/1000 downlink ports

Cisco Nexus C2348UPQ FEX

- 1000/10000 downlink ports

Cisco Nexus C2348TQ-10GE FEX

- 100/1000/10000 downlink ports

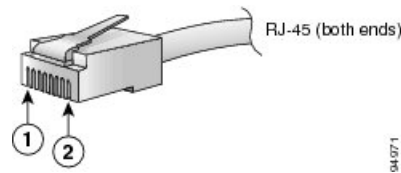


**Caution**

To comply with GR-1089 intrabuilding, lightning immunity requirements, you must use a foil twisted-pair (FTP) cable that is properly grounded at both ends.

The following figure shows the RJ-45 connector.

*Figure 8: RJ-45 Connector*



1	Pin 1	2	Pin 2
---	-------	---	-------

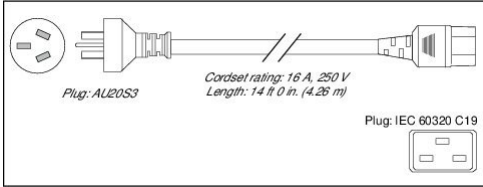
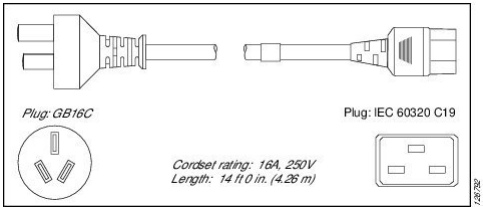
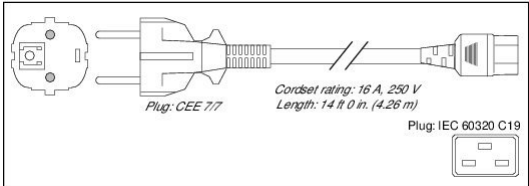
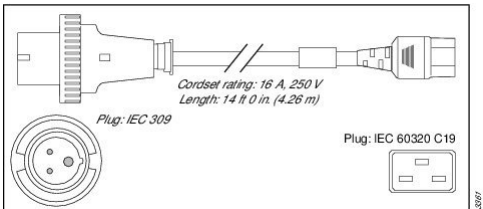
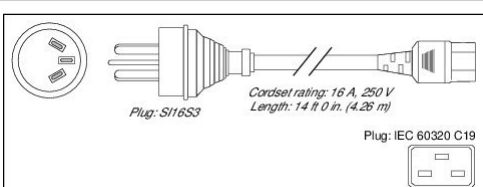
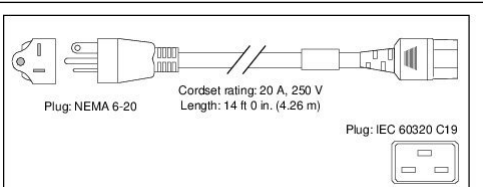
## Power Supply Cable Specifications

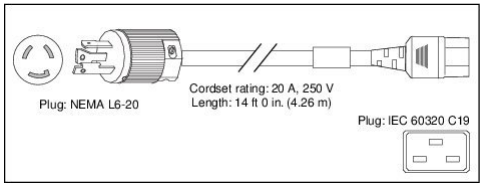
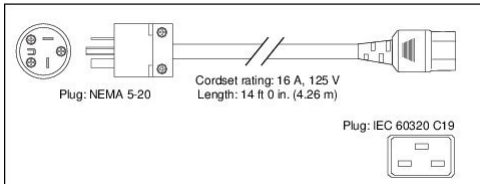
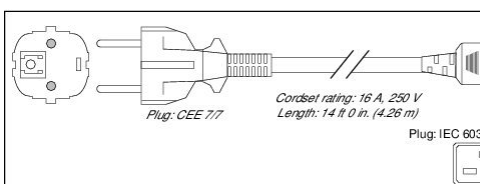
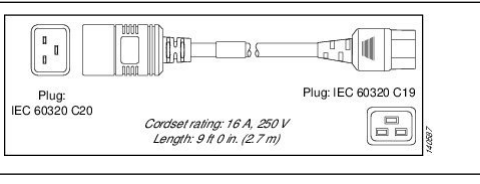
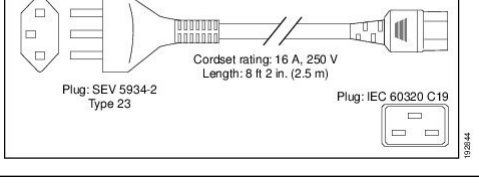


**Note**

If you do not order the optional power cord with the system, you are responsible for selecting the appropriate power cord for the product. Using a non-compatible power cord with this product may result in electrical safety hazard. Orders delivered to Argentina, Brazil, and Japan must have the appropriate power cord ordered with the system.

# 3-kW AC Power Cord Specifications

Locale	Power Cord Part Number	Cord Set Rating	Power Cord Illustration
Australia and New Zealand	CAB-AC-16A-AUS	16A, 250 VAC	 <p>Plug: AU20S3</p> <p>Cordset rating: 16 A, 250 V Length: 14 ft 0 in. (4.26 m)</p> <p>Plug: IEC 60320 C19</p>
Peoples Republic of China	CAB-AC-16A-CH	16A, 250 VAC	 <p>Plug: GB16C</p> <p>Cordset rating: 16 A, 250 V Length: 14 ft 0 in. (4.26 m)</p> <p>Plug: IEC 60320 C19</p>
Continental Europe	CAB-AC-2500W-EU	16A, 250 VAC	 <p>Plug: CEE 7/7</p> <p>Cordset rating: 16 A, 250 V Length: 14 ft 0 in. (4.26 m)</p> <p>Plug: IEC 60320 C19</p>
International	CAB-AC-2500W-INT	16A, 250 VAC	 <p>Plug: IEC 309</p> <p>Cordset rating: 16 A, 250 V Length: 14 ft 0 in. (4.26 m)</p> <p>Plug: IEC 60320 C19</p>
Israel	CAB-AC-2500W-ISRL	16A, 250 VAC	 <p>Plug: SI16S3</p> <p>Cordset rating: 16 A, 250 V Length: 14 ft 0 in. (4.26 m)</p> <p>Plug: IEC 60320 C19</p>
Japan and North America (non locking) 200-240 VAC operation	CAB-9K16A-US1	16A, 250 VAC	 <p>Plug: NEMA 6-20</p> <p>Cordset rating: 20 A, 250 V Length: 14 ft 0 in. (4.26 m)</p> <p>Plug: IEC 60320 C19</p>

Locale	Power Cord Part Number	Cord Set Rating	Power Cord Illustration
Japan and North America (locking) 200-240 VAC operation	CAB-AC-16A-TWLK	16A, 250 VAC	
Japan and North America 100-120 VAC operation	CAB-7513AC	16A, 250 VAC	
Korea	CAB-9K16A-KOR	16A, 250 VAC	
Power distribution unit (PDU)	CAB-C19-CBN	16A, 250 VAC	
Switzerland	CAB-ACS-16	16A, 250 VAC	

## 3.5-kW HVAC/HVDC Power Supply AC Power Cord Specifications

Locale and Description	PID	Cisco Part Number (CPN)	Length	Cord Set Rating	Power Cord Illustration
Argentina, IRSM 2073/Saf-D-Grid	CAB-AC-16A-SG-AR	37-1649-01	14' 0" (4.26 m)	16A, 250 VAC	<a href="#">Figure 9: CAB-AC-16A-SG-AR Power Cord and Plugs for the 3.5-kW HVAC/HVDC Power Supply Unit, on page 40</a>

Locale and Description	PID	Cisco Part Number (CPN)	Length	Cord Set Rating	Power Cord Illustration
Australia and New Zealand, AU20LS3/Saf-D-Grid	CAB-AC-16A-SG-AZ	37-1661-01	14' 0" (4.26 m)	16A, 250 VAC	Figure 10: CAB-AC-16A-SG-AZ Power Cord and Plugs for the 3.5-kW HVAC/HVDC Power Supply Unit, on page 41
Brazil, EL224/Saf-D-Grid	CAB-AC-16A-SG-BR	37-1650-01	14' 0" (4.26 m)	16A, 250 VAC	Figure 11: CAB-AC-16A-SG-BR Power Cord and Plugs for the 3.5-kW HVAC/HVDC Power Supply Unit, on page 41
Peoples Republic of China, GB 16C/Saf-D-Grid	CAB-AC-16A-SG-CH	37-1655-01	14' 0" (4.26 m)	16A, 250 VAC	Figure 12: CAB-AC-16A-SG-CH Power Cord and Plugs for the 3.5-kW HVAC/HVDC Power Supply Unit, on page 41
Continental Europe, CEE 7-7/Saf-D-Grid	CAB-AC-16A-SG-EU	37-1660-01	14' 0" (4.26 m)	16A, 250 VAC	Figure 13: CAB-AC-16A-SG-EU Power Cord and Plugs for the 3.5-kW HVAC/HVDC Power Supply Unit, on page 41
India, SABS 164-1/Saf-D-Grid	CAB-AC-16A-SG-IND	37-1648-01	14' 0" (4.26 m)	16A, 250 VAC	Figure 14: CAB-AC-16A-SG-IND Power Cord and Plugs for the 3.5-kW HVAC/HVDC Power Supply Unit, on page 42
International, IEC60309/Saf-D-Grid	CAB-AC-16A-SG-IN	37-1659-01	14' 0" (4.26 m)	16A, 250 VAC	Figure 15: CAB-AC-16A-SG-IN Power Cord and Plugs for the 3.5-kW HVAC/HVDC Power Supply Unit, on page 42

Locale and Description	PID	Cisco Part Number (CPN)	Length	Cord Set Rating	Power Cord Illustration
Israel, SI 16S3/Saf-D-Grid	CAB-AC-16A-SG-IS	37-1658-01	14' 0" (4.26 m)	16A, 250 VAC	Figure 16: CAB-AC-16A-SG-IS Power Cord and Plugs for the 3.5-kW HVAC/HVDC Power Supply Unit, on page 42
Italy, CEI 23-50/Saf-D-Grid to IEC-C19	CAB-AC-16A-SG-IT	37-1651-01	14' 0" (4.26 m)	16A, 250 VAC	Figure 17: CAB-AC-16A-SG-IT Power Cord and Plugs for the 3.5-kW HVAC/HVDC Power Supply Unit, on page 43
North America (non locking) 110 VAC operation, Straight Blade, NEMA 5-20P/Saf-D-Grid	CAB-AC-20A-SG-US	37-1662-01	14' 0" (4.26 m)	20A, 110 VAC	Figure 18: CAB-AC-20A-SG-US Power Cord and Plugs for the 3.5-kW HVAC/HVDC Power Supply Unit, on page 43
North America (locking) 125 VAC operation, Twist Lock, NEMA L5-20/Saf-D-Grid	CAB-AC-20A-SG-US1	37-1652-01	14' 0" (4.26 m)	20A, 125 VAC	Figure 19: CAB-AC-20A-SG-US1 Power Cord and Plugs for the 3.5-kW HVAC/HVDC Power Supply Unit, on page 43
North America (non locking) 200-240 VAC operation, Straight Blade, NEMA 6-20/Saf-D-Grid	CAB-AC-20A-SG-US2	37-1657-01	14' 0" (4.26 m)	20A, 250 VAC	Figure 20: CAB-AC-20A-SG-US2 Power Cord and Plugs for the 3.5-kW HVAC/HVDC Power Supply Unit, on page 43
North America (locking) 200-240 VAC operation, Twist Lock, NEMA L6-20/Saf-D-Grid	CAB-AC-20A-SG-US3	37-1656-01	14' 0" (4.26 m)	20A, 250 VAC	Figure 21: CAB-AC-20A-SG-US3 Power Cord and Plugs for the 3.5-kW HVAC/HVDC Power Supply Unit, on page 44

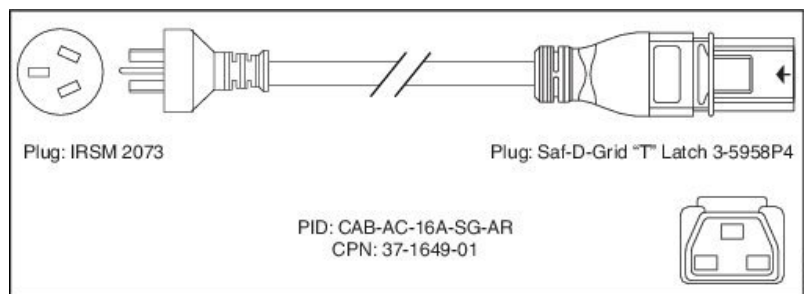
Locale and Description	PID	Cisco Part Number (CPN)	Length	Cord Set Rating	Power Cord Illustration
North America 277 VAC operation, NEMA L7-20P/Saf-D-Grid	CAB-AC-20A-SG-US4	37-1645-01	14' 0" (4.26 m)	20A, 277 VAC	Figure 22: CAB-AC-20A-SG-US4 Power Cord and Plugs for the 3.5-kW HVAC/HVDC Power Supply Unit, on page 44
North America Cabinet Jumper Power Distribution Unit (PDU), Cabinet Jumper PDU, IEC C20/Saf-D-Grid	CAB-AC-20A-SG-C20	37-1653-01	14' 0" (4.26 m)	20A, 250 VAC	Figure 23: CAB-AC-20A-SG-C20 Power Cord and Plugs for the 3.5-kW HVAC/HVDC Power Supply Unit, on page 44
South Africa, EL/Saf-D-Grid	CAB-AC-16A-SG-SA	37-1647-01	14' 0" (4.26 m)	16A, 250 VAC	Figure 24: CAB-AC-16A-SG-SA Power Cord and Plugs for the 3.5-kW HVAC/HVDC Power Supply Unit, on page 44
Korea, Src/Saf-D-Grid	CAB-AC-16A-SG-SK	37-1646-01	14' 0" (4.26 m)	16A, 250 VAC	Figure 25: CAB-AC-16A-SG-SK Power Cord and Plugs for the 3.5-kW HVAC/HVDC Power Supply Unit, on page 45
Switzerland, SEV 5934-2/Saf-D-Grid	CAB-AC-16A-SG-SW	37-1654-01	14' 0" (4.26 m)	16A, 250 VAC	Figure 26: CAB-AC-16A-SG-SW Power Cord and Plugs for the 3.5-kW HVAC/HVDC Power Supply Unit, on page 45
IEC/EU, Ring Terminal source plug, Ring Terminal/Saf-D-Grid	CAB-HV-25A-SG-IN2	37-1640-01	14' 0" (4.26 m)	20A, 300 VAC/500 VDC	Figure 27: CAB-HV-25A-SG-IN2 Power Cord and Plugs for the 3.5-kW HVAC/HVDC Power Supply Unit, on page 45

Locale and Description	PID	Cisco Part Number (CPN)	Length	Cord Set Rating	Power Cord Illustration
IEC/EU, Saf-D-Grid P10/Saf-D-Grid P4	CAB-HV-25A-SG-IN3	37-100904-01	14' 0" (4.26 m)	20A, 300 VAC	Figure 28: CAB-HV-25A-SG-IN3 Power Cord and Plugs for the 3.5-kW HVAC/HVDC Power Supply Unit, on page 45
North America, Ring Terminal source plug, Ring Terminal/Saf-D-Grid	CAB-HV-25A-SG-US2	37-1641-01	14' 0" (4.26 m)	20A, 300 VAC/500 VDC	Figure 29: CAB-HV-25A-SG-US2 Power Cord and Plugs for the 3.5-kW HVAC/HVDC Power Supply Unit, on page 46
North America, Saf-D-Grid P10/Saf-D-Grid P4	CAB-HV-25A-SG-US5	37-100903-01	14' 0" (4.26 m)	20A, 300 VAC	Figure 30: CAB-HV-25A-SG-US5 Power Cord and Plugs for the 3.5-kW HVAC/HVDC Power Supply Unit, on page 46



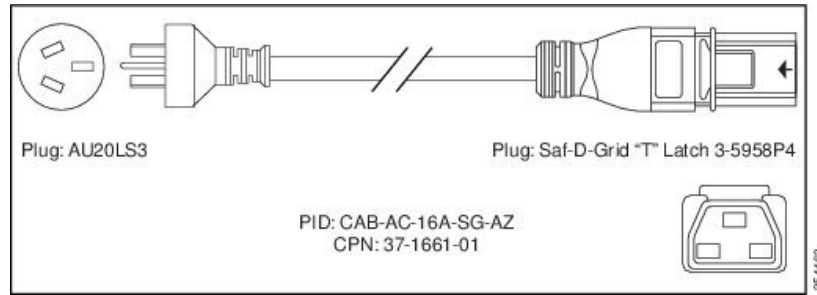
**Note** All power cords will not be orderable at first customer shipment (FCS).

**Figure 9: CAB-AC-16A-SG-AR Power Cord and Plugs for the 3.5-kW HVAC/HVDC Power Supply Unit**

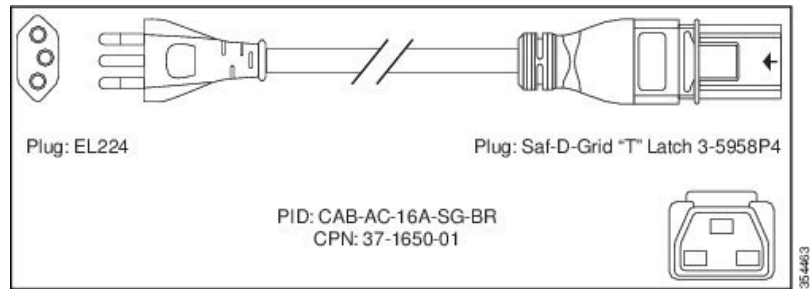




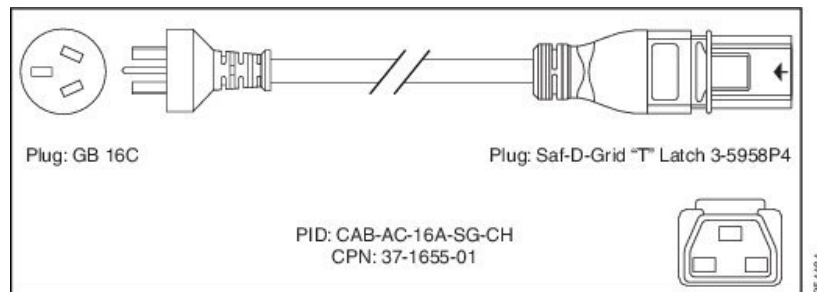
**Figure 10: CAB-AC-16A-SG-AZ Power Cord and Plugs for the 3.5-kW HVAC/HVDC Power Supply Unit**



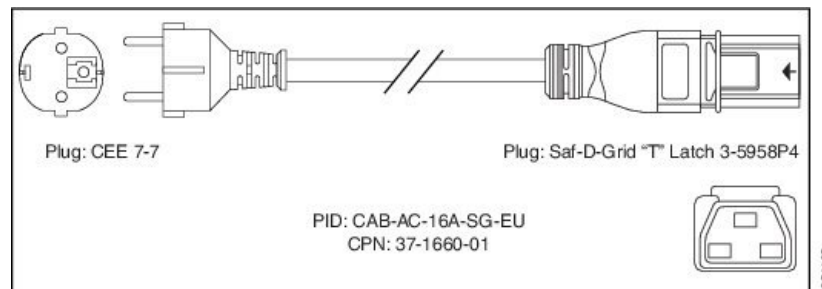
**Figure 11: CAB-AC-16A-SG-BR Power Cord and Plugs for the 3.5-kW HVAC/HVDC Power Supply Unit**



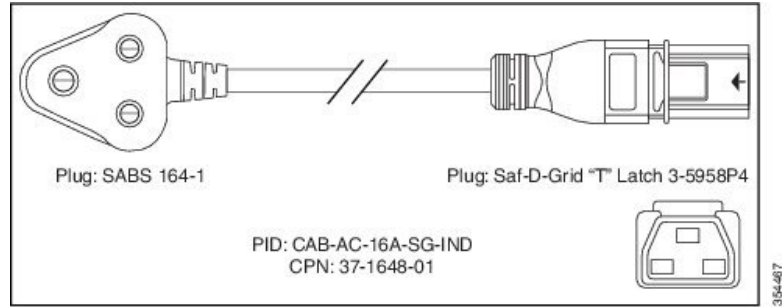
**Figure 12: CAB-AC-16A-SG-CH Power Cord and Plugs for the 3.5-kW HVAC/HVDC Power Supply Unit**



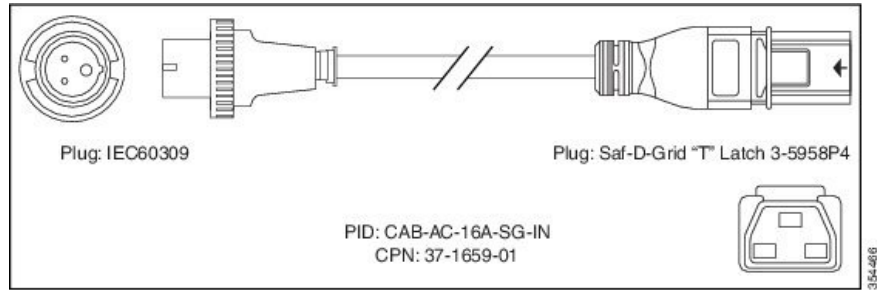
**Figure 13: CAB-AC-16A-SG-EU Power Cord and Plugs for the 3.5-kW HVAC/HVDC Power Supply Unit**



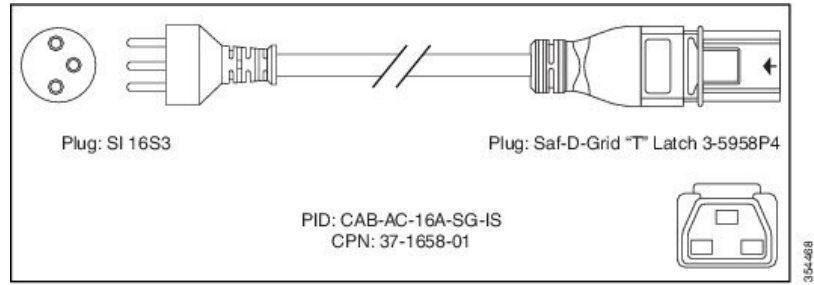
**Figure 14: CAB-AC-16A-SG-IND Power Cord and Plugs for the 3.5-kW HVAC/HVDC Power Supply Unit**



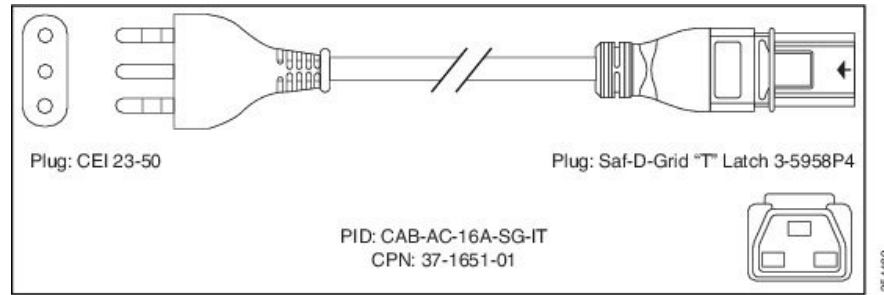
**Figure 15: CAB-AC-16A-SG-IN Power Cord and Plugs for the 3.5-kW HVAC/HVDC Power Supply Unit**



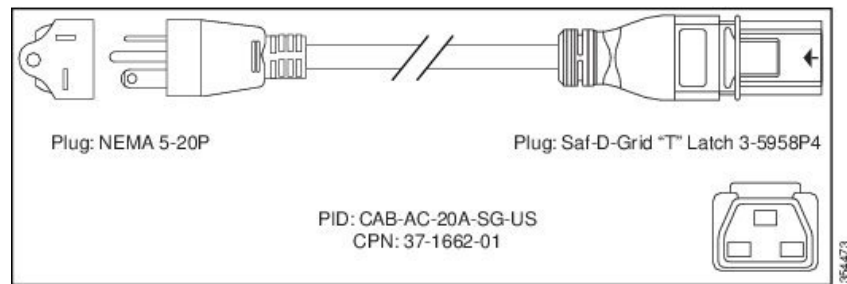
**Figure 16: CAB-AC-16A-SG-IS Power Cord and Plugs for the 3.5-kW HVAC/HVDC Power Supply Unit**



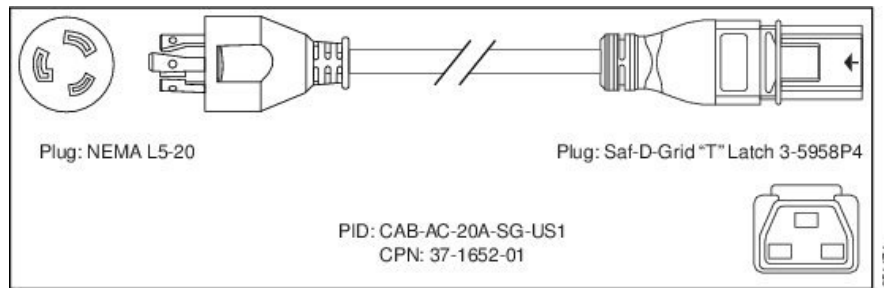
**Figure 17: CAB-AC-16A-SG-IT Power Cord and Plugs for the 3.5-kW HVAC/HVDC Power Supply Unit**



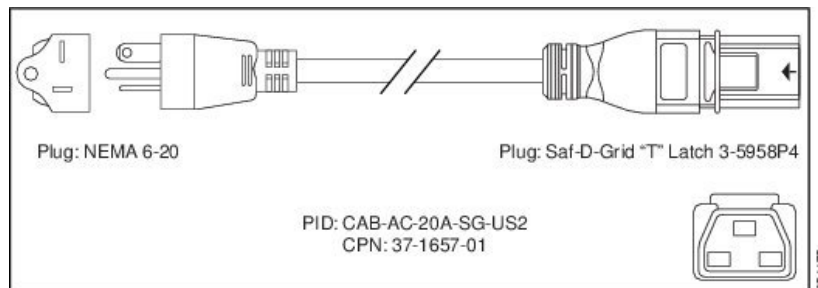
**Figure 18: CAB-AC-20A-SG-US Power Cord and Plugs for the 3.5-kW HVAC/HVDC Power Supply Unit**



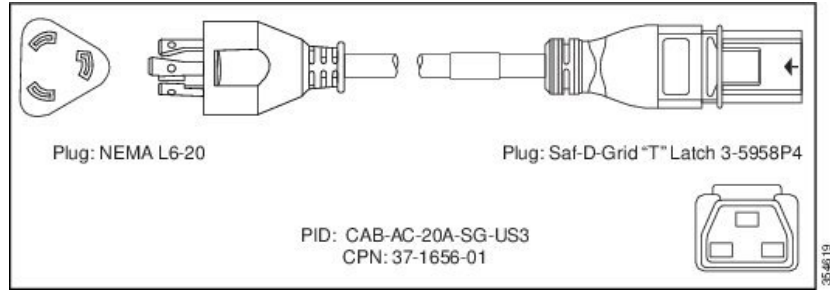
**Figure 19: CAB-AC-20A-SG-US1 Power Cord and Plugs for the 3.5-kW HVAC/HVDC Power Supply Unit**



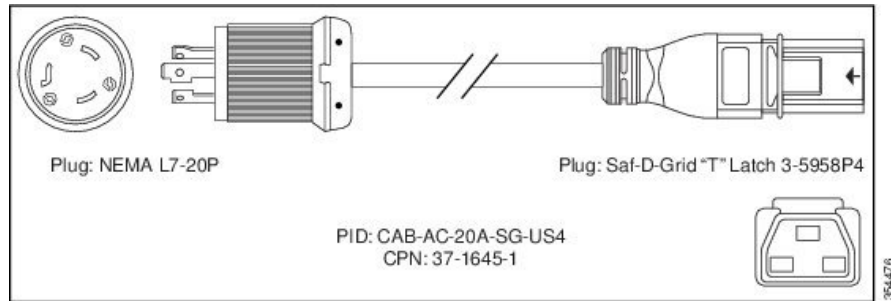
**Figure 20: CAB-AC-20A-SG-US2 Power Cord and Plugs for the 3.5-kW HVAC/HVDC Power Supply Unit**



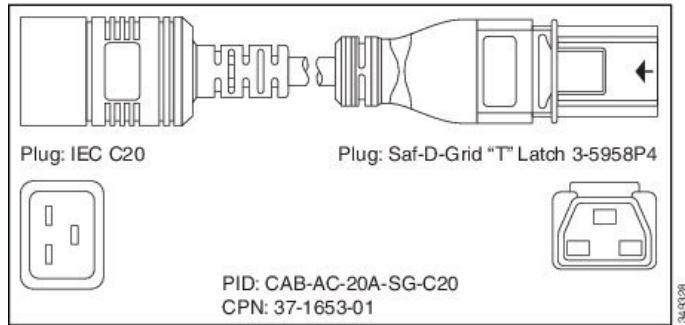
**Figure 21: CAB-AC-20A-SG-US3 Power Cord and Plugs for the 3.5-kW HVAC/HVDC Power Supply Unit**



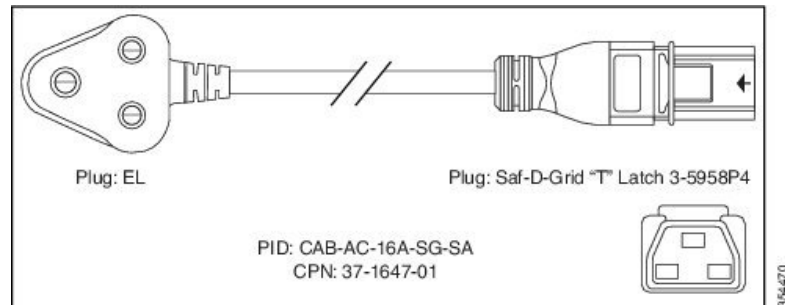
**Figure 22: CAB-AC-20A-SG-US4 Power Cord and Plugs for the 3.5-kW HVAC/HVDC Power Supply Unit**



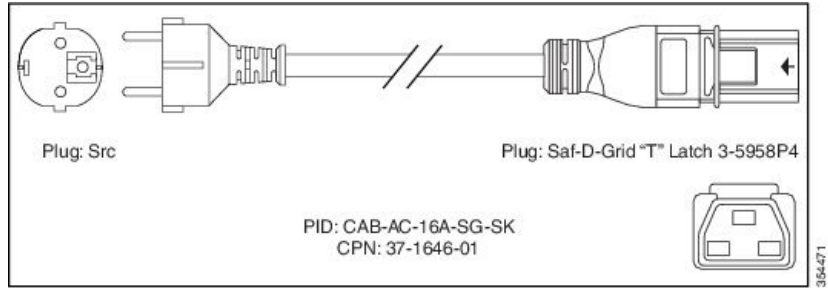
**Figure 23: CAB-AC-20A-SG-C20 Power Cord and Plugs for the 3.5-kW HVAC/HVDC Power Supply Unit**



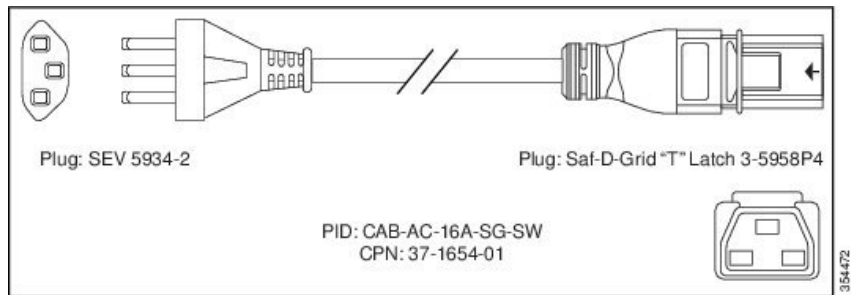
**Figure 24: CAB-AC-16A-SG-SA Power Cord and Plugs for the 3.5-kW HVAC/HVDC Power Supply Unit**



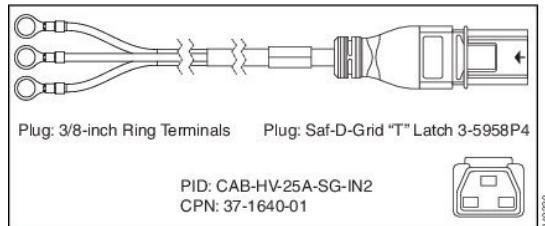
**Figure 25: CAB-AC-16A-SG-SK Power Cord and Plugs for the 3.5-kW HVAC/HVDC Power Supply Unit**



**Figure 26: CAB-AC-16A-SG-SW Power Cord and Plugs for the 3.5-kW HVAC/HVDC Power Supply Unit**



**Figure 27: CAB-HV-25A-SG-IN2 Power Cord and Plugs for the 3.5-kW HVAC/HVDC Power Supply Unit**



**Figure 28: CAB-HV-25A-SG-IN3 Power Cord and Plugs for the 3.5-kW HVAC/HVDC Power Supply Unit**

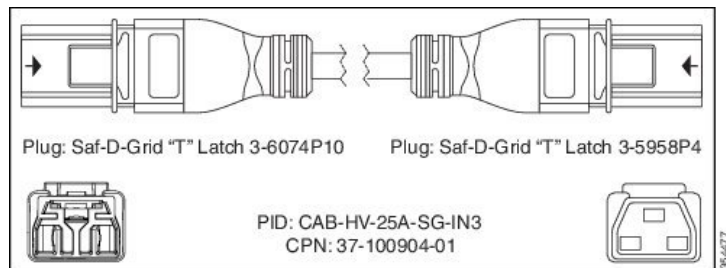


Figure 29: CAB-HV-25A-SG-US2 Power Cord and Plugs for the 3.5-kW HVAC/HVDC Power Supply Unit

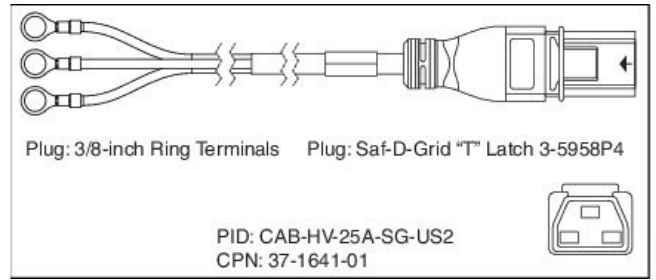
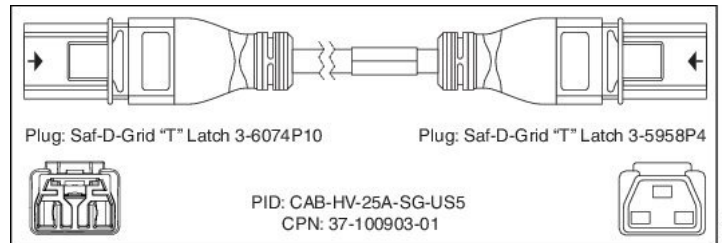


Figure 30: CAB-HV-25A-SG-US5 Power Cord and Plugs for the 3.5-kW HVAC/HVDC Power Supply Unit



### 3-kW DC Power Cord Specifications

Locale	Part Number	Cord Ratings	Power Cord Comments
All	<a href="#">15</a>	45 A	6 AWG

<sup>15</sup> Power cords used for the 3-kW DC power supply are supplied by the customer.

### 3.5-kW HVAC/HVDC Power Supply DC Power Cord Specifications

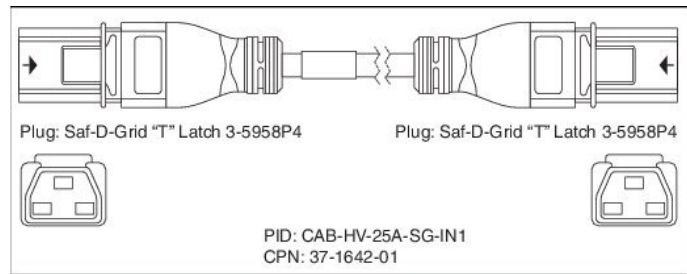
Locale and Description	PID	Cisco Part Number (CPN)	Length	Cord Set Rating	Power Cord Illustration
International, Saf-D-Grid/Saf-D-Grid	CAB-HV-25A-SG-IN1	37-1642-01	14' 0" (4.26 m)	20 A, 400 VDC	<a href="#">Figure 31: CAB-HV-25A-SG-IN1 Power Cord and Plugs for the 3.5-kW HVAC/HVDC Power Supply Unit, on page 47</a>

Locale and Description	PID	Cisco Part Number (CPN)	Length	Cord Set Rating	Power Cord Illustration
International, Ring Terminal source plug, Ring Terminal/Saf-D-Grid	CAB-HV-25A-SG-IN2	37-1640-01	14' 0" (4.26 m)	20 A, 300 VAC/500 VDC	Figure 32: CAB-HV-25A-SG-IN2 Power Cord and Plugs for the 3.5-kW HVAC/HVDC Power Supply Unit, on page 48
North America, Saf-D-Grid/Saf-D-Grid	CAB-HV-25A-SG-US1	37-1643-01	14' 0" (4.26 m)	20 A, 400 VDC	Figure 33: CAB-HV-25A-SG-US1 Power Cord and Plugs for the 3.5-kW HVAC/HVDC Power Supply Unit, on page 48
North America, Ring Terminal source plug, Ring Terminal/Saf-D-Grid	CAB-HV-25A-SG-US2	37-1641-01	14' 0" (4.26 m)	20 A, 300 VAC/500 VDC	Figure 34: CAB-HV-25A-SG-US2 Power Cord and Plugs for the 3.5-kW HVAC/HVDC Power Supply Unit, on page 48

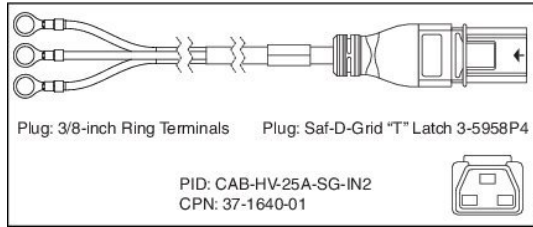


**Note** All power cords will not be orderable at first customer shipment (FCS).

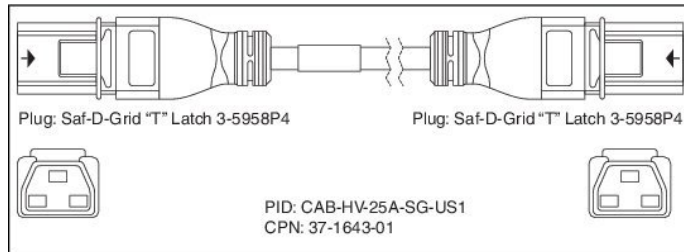
**Figure 31: CAB-HV-25A-SG-IN1 Power Cord and Plugs for the 3.5-kW HVAC/HVDC Power Supply Unit**



**Figure 32: CAB-HV-25A-SG-IN2 Power Cord and Plugs for the 3.5-kW HVAC/HVDC Power Supply Unit**



**Figure 33: CAB-HV-25A-SG-US1 Power Cord and Plugs for the 3.5-kW HVAC/HVDC Power Supply Unit**



**Figure 34: CAB-HV-25A-SG-US2 Power Cord and Plugs for the 3.5-kW HVAC/HVDC Power Supply Unit**

